

## Adjustable Carbon Attenuators

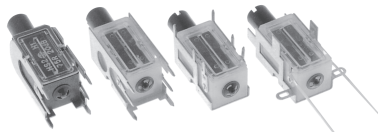

### FEATURES

- Model M2001H is for matching the characteristic impedance of coaxial antenna cables and is suitable for antenna amplifiers of up to 900MHz.

### MECHANICAL SPECIFICATIONS

- Casing:** Plastic material, dust protected.  
**Shielded Basket/Pins:** Electroplated SN, 5 $\mu$ .  
**Mounting:** Fish-plates.  
**Adjustment:** Insulated plastic shaft with screwdriver slot and .079 inch [2mm] hexagon.  
**Terminals:** Silver plated lugs, tinned pins.  
**Nominal angle of rotation:** 3 (+ 3.0 - 0.5) revolutions. 6 revolutions on request.  
**Operating torque:** .56 to 1.96 oz. in.  
**End stop torque:** 4.97 oz. in. (7 Ncm). Fixed stop at 3 revolutions. 6 revolutions, clutch mechanism, no end stop.  
**Weight:** .13 to .14 oz.

### MATERIAL SPECIFICATIONS

- Cover:** Makrolon 94V2.  
**Shaft:** Durethan 94V0.  
**Case:** Hostaform 94HB.

STANDARD ELECTRICAL SPECIFICATIONS	
Resistive Element	Carbon on laminated paper
Wiper Contact	Metal
Impedance	75 ohms, 50 ohms (60 ohms on request)
Power Rating	.25 watt
Nominal Attenuation and Tolerance	20dB (+ 5 - 2dB), 10dB (+ 2 - 2dB), 6dB on request
Adjustable Minimum Attenuation	$\leq 0.5$ dB
Variation in Attenuation Due to Frequency	
up to 300MHz	$\leq 0.25$ dB
over 300 to 900MHZ	$\leq 1$ dB
Reflexion Attenuation	.5 to 20dB attenuation
up to 300MHz	$\geq 20$ dB
up to 900MHz	$\geq 15$ dB
Temperature Limits	- 25°C to + 70°C

**NOTE:** Typical curves for transmission and return loss available.

### DIMENSIONAL CONFIGURATIONS [in millimeters]

M2001HP1

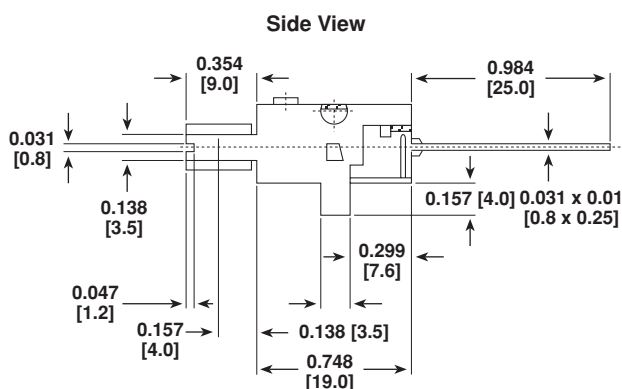

End View (All Versions)

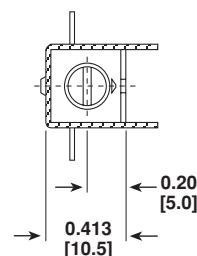

Top View

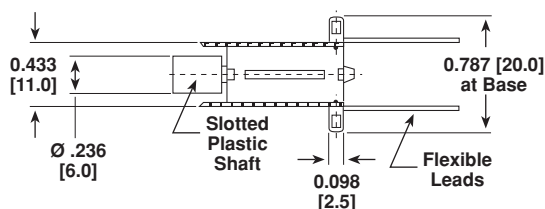

Electrical Circuit

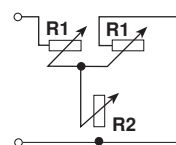

## DIMENSIONAL CONFIGURATIONS [in millimeters]

### M2001HP2

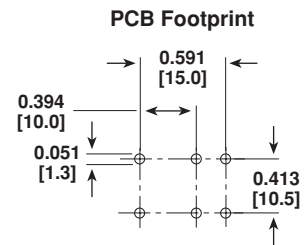
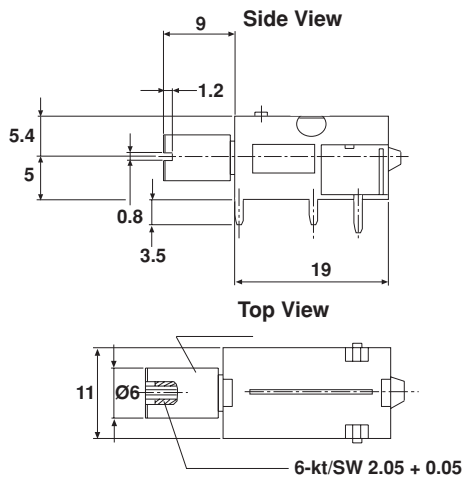

### Electrical Circuit

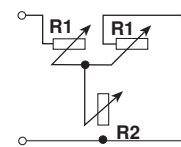

### M2001HS2

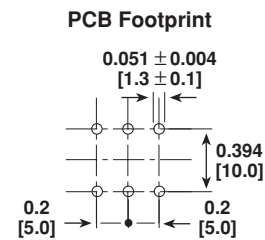
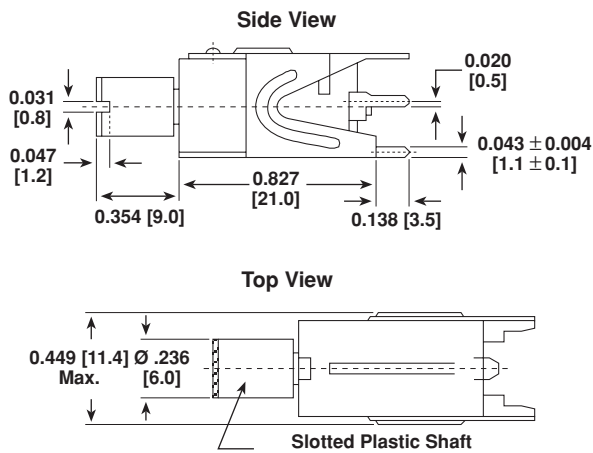

### Electrical Circuit

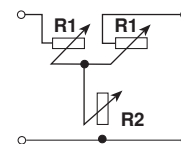

### M2001HP3

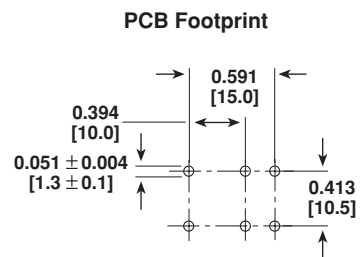
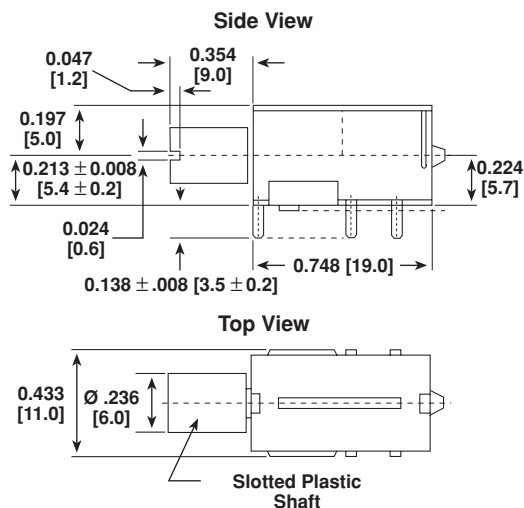

### Electrical Circuit

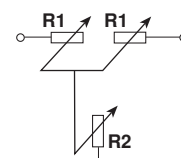



## PACKAGING

**M2001HP1, M2001HS2:** 250 pieces in bulk.  
**M2001HP2, M2001HP3:** 100 pieces in plastic insert.

## HOW TO ORDER

