

# LZ93B53

## Synchronous Signal Generator for CCD

### DESCRIPTION

The LZ93B53 is a CMOS synchronous signal generator LSI which provides B/W TV synchronous pulses and video signal processing pulses, in combination with the timing signal generator LSI (LZ93N61, LZ95F50, or LZ93F33).

### FEATURES

- . Switchable between 270000 pixels B/W CCD and 320000 pixels B/W CCD
- . Switchable between EIA and CCIR systems
- Single + 5 V power supply
- . External synchronization is possible
- . Package : 1 8-pin MFP(MFPOI 8-P)

### PIN CONNECTIONS

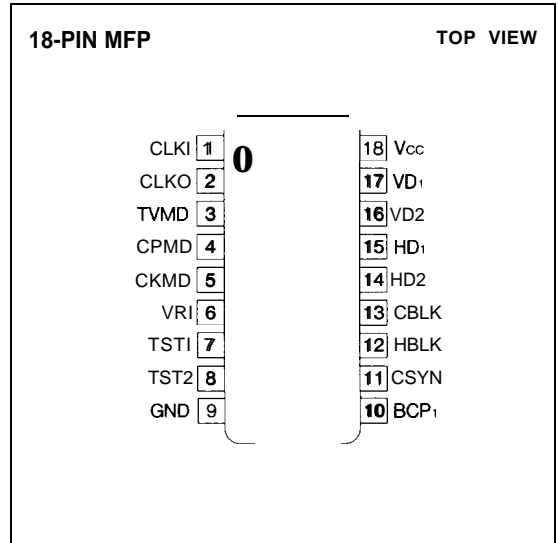

### BLOCK DIAGRAM

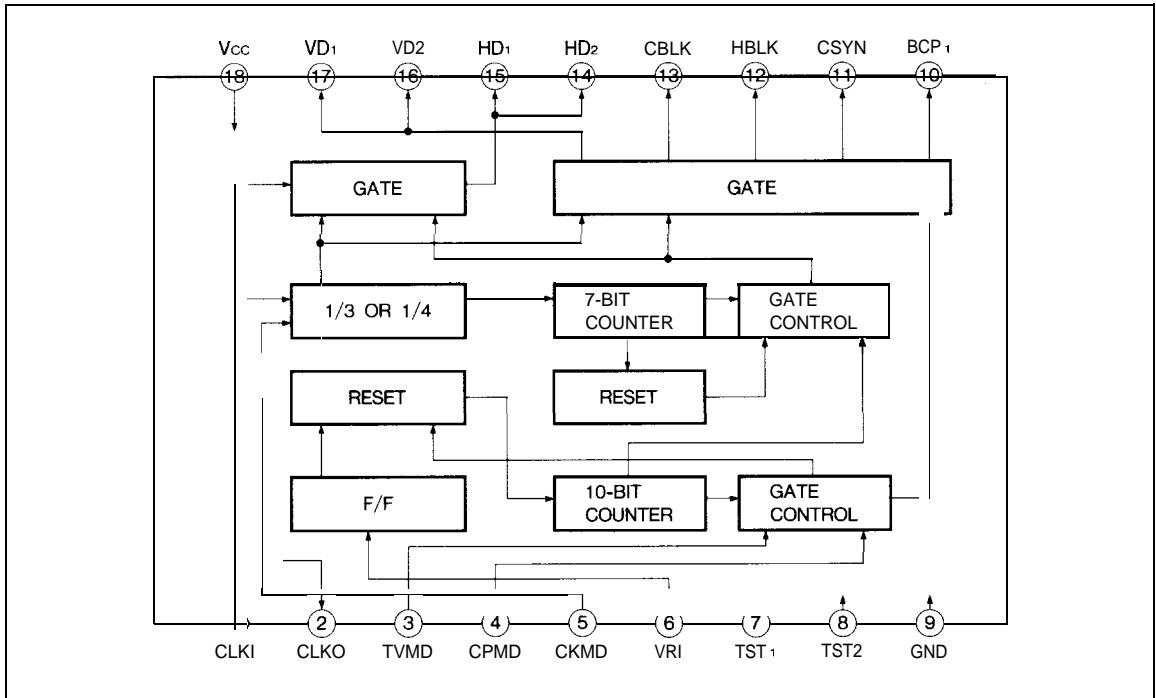

## ABSOLUTE MAXIMUM RATINGS

PARAMETER	SYMBOL	RATING	UNIT
Power voltage	V <sub>cc</sub>	- 0.3 to 7.0	v
Input voltage	V <sub>I</sub>	-0.3 to V <sub>cc</sub> + 0.3	v
Output voltage	V <sub>o</sub>	- 0.3 to V <sub>cc</sub> + 0.3	v
Operating temperature	T <sub>opr</sub>	-20 to +70	°C
Storage temperature	T <sub>stg</sub>	-55 to +150	°C

## DC CHARACTERISTICS



(V<sub>cc</sub> = +5 V ± 10%, T<sub>a</sub> = -20 to +70°C)





PARAMETER	SYMBOL	CONDITIONS	MIN.	TYP.	MAX.	UNIT	NOTE
Low level input voltage	V <sub>IL</sub>				1.5	v	1
High level input voltage	V <sub>IH</sub>		3.5			v	
High level threshold voltage	V <sub>T+</sub>	Schmitt buffer			3.7	v	2
Low level threshold voltage	V <sub>T-</sub>	Schmitt buffer	1.0			v	
Hysteresis voltage	V <sub>T+</sub> - V <sub>T-</sub>	Schmitt buffer	0.4			v	
Low level output voltage	V <sub>OL</sub>	I <sub>OL</sub> = 4 mA			0.4	v	3
High level output voltage	V <sub>OH</sub>	I <sub>OH</sub> = -2 mA	4.0			v	
Low level input current	I <sub>IL1</sub>	V <sub>I</sub> = 0 V			1.0	μA	4
Low level input current	I <sub>IL2</sub>	V <sub>I</sub> = 0 V	8.0		60	μA	5
High level input current	I <sub>IH1</sub>	V <sub>I</sub> = V <sub>cc</sub>			1.0	μA	6
High level input current	I <sub>IH2</sub>	V <sub>I</sub> = V <sub>cc</sub>	8.0		60	μA	7

## NOTES :

1. Applied to inputs (IC, ICU, ICD).
2. Applied to input (ICSU).
3. Applied to all outputs (O).
4. Applied to inputs (IC, ICU, ICSU).
5. Applied to input (ICD).
6. Applied to inputs (IC, ICD).
7. Applied to inputs (ICU, ICSU).

## PIN FUNCTION

PIN NO.	SYMBOL	I/O	POLARITY	PIN NAME	FUNCTION									
1	CLKI	I C		Main clock	<p>This is a pin to input the clock which is used as the reference of the horizontal and vertical pulses. This pin should be connected to DO on the timing LSI. The frequency varies depending on CKMD (pin 5) as follows.</p> <ul style="list-style-type: none"> <li>● EIA system               <ul style="list-style-type: none"> <li>270000 pixels fck : 9.534964 MHz(606 fH)</li> <li>360000 pixels fck : 12.713285 MHz(808 fH)</li> </ul> </li> <li>● CCIR system               <ul style="list-style-type: none"> <li>320000 pixels fck : 9.656250 MHz(618 fH)</li> <li>420 000 pixels fck : 12.875000 MHz(824 fH)</li> </ul> </li> </ul>									
2	CLKO	O		Clock out	This is an inverted output pin for CLKI (pin 1).									
3	TVMD	ICD	-	TV mode select	<p>This is a pin to select TV systems.</p> <ul style="list-style-type: none"> <li>● Low level : EIA system</li> <li>● High level : CCIR system</li> </ul>									
4	CPMD	ICU	-	Clamp pulse mode select	<p>This is a pin to control stop and continuance of BCPI (pin 10) within the vertical blanking period.</p> <ul style="list-style-type: none"> <li>● High level : BCPI outputs continuous pulses.</li> <li>● Low level : BCP stops outputting composite pulses while there is no effective pixel within the V blanking period.</li> </ul>									
5	CKMD	ICU	-	Clock mode select	<p>This is an input pin to switch the frequency division in accordance with the area sensor as follows.</p> <table border="1" data-bbox="713 912 1215 1048"> <thead> <tr> <th data-bbox="713 912 941 980">Frequency division output</th> <th data-bbox="941 912 1070 980">1/3</th> <th data-bbox="1070 912 1215 980">1/4</th> </tr> </thead> <tbody> <tr> <td data-bbox="713 980 941 1014">CKMD</td> <td data-bbox="941 980 1070 1014">High</td> <td data-bbox="1070 980 1215 1014">Low</td> </tr> <tr> <td data-bbox="713 1014 941 1048">Number of pixels</td> <td data-bbox="941 1014 1070 1048">270000</td> <td data-bbox="1070 1014 1215 1048">360000</td> </tr> </tbody> </table>	Frequency division output	1/3	1/4	CKMD	High	Low	Number of pixels	270000	360000
Frequency division output	1/3	1/4												
CKMD	High	Low												
Number of pixels	270000	360000												
6	VRI	ICSU	u	Vertical reset	<p>This is an input pin for the external V reset pulse which is used to apply vertical synchronization to the counter (2 fck counter) on the synchronization. This resetting takes priority over the internal resetting. Since the rise of input at VRI is taken at the horizontal synchronous frequency (2 fH) which is two times as high as the internal frequency, when the vertical pulses which were separated in terms of frequency from the composite synchronous signal from other equipment are used, the fall must have a phase difference of less than 1/2 fH compared with the start timing of the vertical synchronous signal. When the internal synchronization is obtained, the High level should be selected. The input is designed as a schmitt trigger buffer.</p>									
7	TST <sub>1</sub>	ICD	-	Test terminal 1	This is an input pin for tests, Typically, this pin should be open or at the Low level.									

PIN NO.	SYMBOL	I/O	POLARITY	PIN NAME	FUNCTION
8	TST <sub>2</sub>	ICD		Test terminal 2	This is an input pin for tests. Typically, this pin should be open or at the Low level.
9	GND	—		Ground	This is a grounding pin.
10	BCP <sub>1</sub>	0		Optical block clamp pulse	This pin output pulse which is used to clamp optical black on each line of the sensor output. Typically, these are horizontal synchronization continuous pulses. However, setting CPMD (pin 4) to the Low level allows the composite output which becomes the Low level while there is no effective pixel within the vertical blanking period.
11	CSYN	0		Composite synchronous signal	This pin outputs EIA and CCIR standard composite synchronous signals. ● EIA system : Compatible with RS-170 · CCIR system : Compatible with CCIR
12	HBLK	0		Horizontal blanking pulse	This pin outputs a pulse to stop the horizontal transfer pulses which drive the horizontal register in the area sensor.
13	CBLK	0		Composite blanking pulse	This pin outputs pulses which are used for video blanking in the encoder. · EIA system : 11.01 μs, V20 H is cleared. · CCIR system : 12.12 μs, V25 H is cleared.
14	HD2	0		Horizontal drive pulse 2	This pin outputs pulses which are synchronous with the start of each line and used as the H reference of the timing LSI.
15	HDI	0		Horizontal drive pulse 1	This pin outputs pulses which are synchronous with the start of each line and used as the H reference of external equipment.
16	VD2	0		Vertical drive pulse 2	This pin outputs pulses which are obtained at the start of each field and used as the V reference of the timing LSI.
17	VDI	0		Vertical drive pulse 1	This pin outputs pulses which are obtained at the start of each field and used as the V reference of external equipment.
18	Vcc	—	—	Power supply	supply +5 V power

IC : Input Din (CMOS level).

ICU : Input pin (CMOS level with pull-up resistor).

ICD : Input pin (CMOS level with pull-down resistor).

ICSU : Schmitt-trigger input pin (CMOS level with pull-up resistor)

0 : Output pin

TIMING DIAGRAM

VERTICAL TIMING < EIA >

(ODD FIELD)

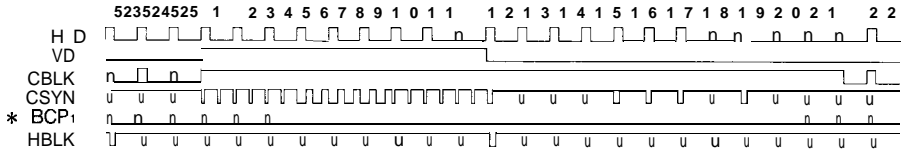

\* CPMD = L

(EVEN FIELD)

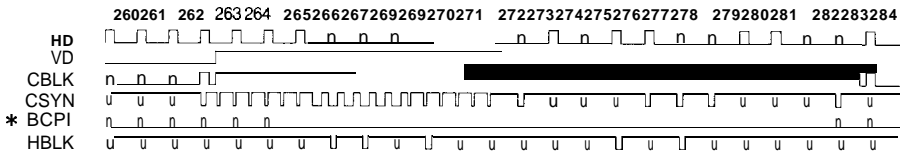

\* CPMD=L

VERTICAL TIMING < CCIR >

(1st, 3rd FIELD)

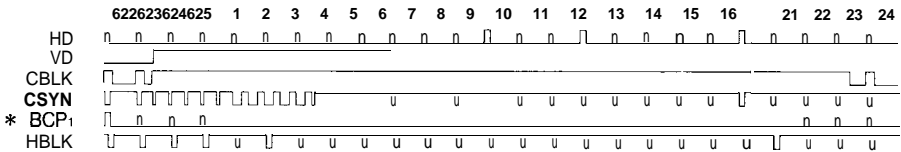

\* CPMD=L

(2nd, 4th FIELD)

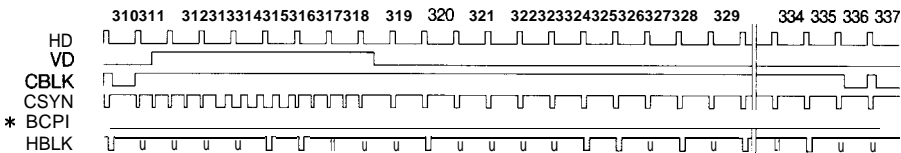

\* CPMD = L

HORIZONTAL TIMING < EIA >

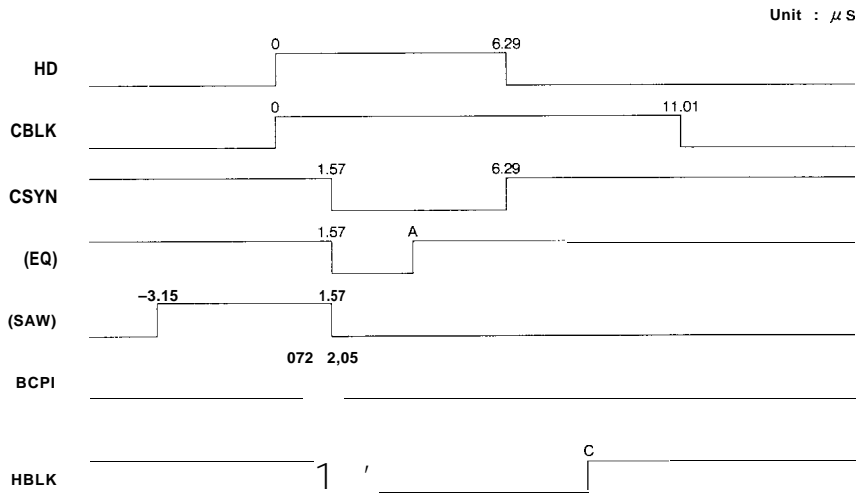

NOTES :

- Applied to the CCD of 542 horizontal pixels (CKMD = H) : A = 3.88, B = 2.94, C = 8.60
- Applied to the CCD of 726 horizontal pixels (CKMD = L) : A = 3.93, B = 2.91, C = 8.57

HORIZONTAL TIMING < CCIR >

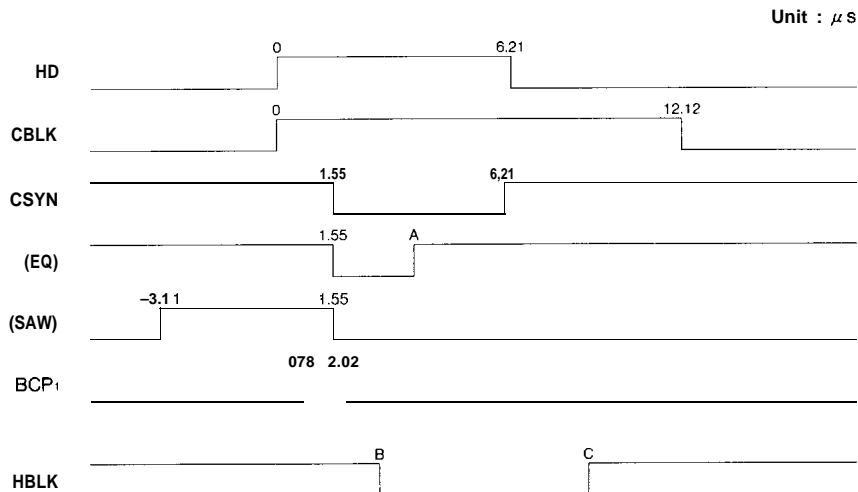

NOTES :

- Applied to the CCD of 542 horizontal pixels (CKMD = H) : A = 3.83, B = 2.90, C = 9.73
- Applied to the CCD of 726 horizontal pixels (CKMD = L) : A = 3.88, B = 2.87, C = 9.70