



SANYO Semiconductors

# DATA SHEET

An ON Semiconductor Company

## LV4993TH — Bi-CMOS IC For Portable Audio Equipment Monaural BTL Power Amplifier

### Overview

LV4993TH built-in the power amplifier circuit operable at low voltage (1.8V or more) and has additionally the standby function to reduce the current drain. It is power amplifier IC optimal for speaker drive used in battery-driven portable equipment and the low output power system equipment.

### Application

IC recorder, Portable-TV, Radio, Portable-NAVI, LCD-monitor, Digital-photo-frame, and etc.

### Function and Feature

- Monaural BTL power amplifier built-in
  - Standard output power 1 = 1.5W ( $V_{CC} = 5V$ ,  $R_L = 8\Omega$ , THD = 10%)
  - Standard output power 2 = 0.5W ( $V_{CC} = 3V$ ,  $R_L = 8\Omega$ , THD = 10%)
  - Output coupling capacitor not necessary because of differential output type
- Operation at low voltage possible (Operate with two dry battery cells)
  - $V_{CC} = 1.8V$  or more
- Standby function built-in
  - Standard current drain at standby =  $0.02\mu A$  ( $V_{CC} = 5V$ )
- Second amplifier stop control function built-in: For BTL/SE mode switching, and signal muting at BTL mode.
- Overheat protection circuit built-in
- Gain setting possible
  - BTL voltage gain = 0 to 26dB
- Output phase compensation capacitor not necessary

■ Any and all SANYO Semiconductor Co.,Ltd. products described or contained herein are, with regard to "standard application", intended for the use as general electronics equipment (home appliances, AV equipment, communication device, office equipment, industrial equipment etc.). The products mentioned herein shall not be intended for use for any "special application" (medical equipment whose purpose is to sustain life, aerospace instrument, nuclear control device, burning appliances, transportation machine, traffic signal system, safety equipment etc.) that shall require extremely high level of reliability and can directly threaten human lives in case of failure or malfunction of the product or may cause harm to human bodies, nor shall they grant any guarantee thereof. If you should intend to use our products for applications outside the standard applications of our customer who is considering such use and/or outside the scope of our intended standard applications, please consult with us prior to the intended use. If there is no consultation or inquiry before the intended use, our customer shall be solely responsible for the use.

■ Specifications of any and all SANYO Semiconductor Co.,Ltd. products described or contained herein stipulate the performance, characteristics, and functions of the described products in the independent state, and are not guarantees of the performance, characteristics, and functions of the described products as mounted in the customer's products or equipment. To verify symptoms and states that cannot be evaluated in an independent device, the customer should always evaluate and test devices mounted in the customer's products or equipment.

**SANYO Semiconductor Co., Ltd.**

<http://semicon.sanyo.com/en/network>

# LV4993TH

## Specifications

### Maximum Ratings at $T_a = 25^\circ\text{C}$

Parameter	Symbol	Conditions	Ratings	Unit
Maximum supply voltage	$V_{CC}$ max		6	V
Allowable power dissipation	$P_d$ max	PCB mounted*	0.85	W
Maximum junction temperature	$T_j$ max		150	$^\circ\text{C}$
Operating temperature	$T_{opr}$		-40 to +85	$^\circ\text{C}$
Storage temperature	$T_{stg}$		-40 to +150	$^\circ\text{C}$

\* PCB mounted : with 40mm × 40mm × 1.6mm, double-sided glass epoxy circuit board

### Operating Conditions at $T_a = 25^\circ\text{C}$

Parameter	Symbol	Conditions	Ratings	Unit
Recommended supply voltage	$V_{CC}$		5	V
Recommended load resistance	$R_L$		4 to 32	$\Omega$
Allowable operating supply voltage range1	$V_{CC}$ op1	$R_L=8$ to $32\Omega$ , $T_a=-10$ to $85^\circ\text{C}$	* 1.8 to 5.5	V
Allowable operating supply voltage range2	$V_{CC}$ op2	$R_L=8$ to $32\Omega$ , $T_a=-40$ to $85^\circ\text{C}$	2.0 to 5.5	V
Allowable operating supply voltage range3	$V_{CC}$ op3	$R_L=4$ to $7\Omega$ , $T_a=-10$ to $85^\circ\text{C}$	2.0 to 4.0	V
Allowable operating supply voltage range4	$V_{CC}$ op4	$R_L=4$ to $7\Omega$ , $T_a=-40$ to $85^\circ\text{C}$	2.2 to 4.0	V

\* Determine the supply voltage to be used with due consideration of allowable power dissipation.

\* It is assumed the operation guarantee from  $V_{CC}=1.8\text{V}$  to  $2.0\text{V}$ .

### Electrical Characteristics $T_a = 25^\circ\text{C}$ , $V_{CC} = 5\text{V}$ , $f_{in} = 1\text{kHz}$ , $R_L = 8\Omega$ , $V_3=1.6\text{V}$

Parameter	Symbol	Conditions	Ratings			Unit
			min	typ	max	
Quiescent current drain	$I_{CCOP}$	No signal, $R_L = \infty$		3.6	6	mA
Stand-by current drain	$I_{STBY}$	No signal, $R_L = \infty$ , $V_3 = 0.3\text{V}$		0.02	5	$\mu\text{A}$
Maximum output power 1	$P_{OMX1}$	THD = 10%	1.0	1.5		W
Maximum output power 2	$P_{OMX2}$	THD = 10%, $V_{CC} = 3\text{V}$		0.5		W
Voltage gain	VG	$V_{IN} = -10\text{dBV}$	4.4	5.9	7.4	dB
Voltage gain use range	VGR		0		26	dB
Total harmonic distortion	THD	$V_{IN} = -10\text{dBV}$		0.3	1	%
Output noise voltage	$V_{NOUT}$	$R_g = 620\Omega$ , 20 to 20kHz		35	100	$\mu\text{V}_{rms}$
MUTE attenuation level 1	MUTE1	$V_{IN} = 0\text{dBV}$ , $V_3=0.3\text{V}$ (at standby)		-105	-90	dBV
MUTE attenuation level 2	MUTE2	$V_{IN} = 0\text{dBV}$ , $V_2=0.3\text{V}$ (at Second power amplifier stop)		-105	-90	dBV
Ripple rejection ratio	SVRR	$R_g = 620\Omega$ , $f_r = 100\text{Hz}$ , $V_r = -20\text{dBV}$		50		dB
Output offset voltage	$V_{OS}$	$R_g = 620\Omega$	-30		30	mV
Reference (pin 1) voltage	VREF			$0.5V_{CC}$		V
Pin 3 control HIGH voltage	VSTBH	Power amplifier operation mode	1.6		3	V
Pin 3 control LOW voltage	VSTBL	Power amplifier standby mode	0		0.3	V
Pin 2 control HIGH voltage	VCNTH	Second power amplifier operation mode (BTL mode)	1.6		$V_{CC}$	V
Pin 2 control LOW voltage	VCNTL	Second power amplifier standby mode (SE mode)	0		0.3	V

# LV4993TH

## Package Dimensions

unit : mm (typ)

3339

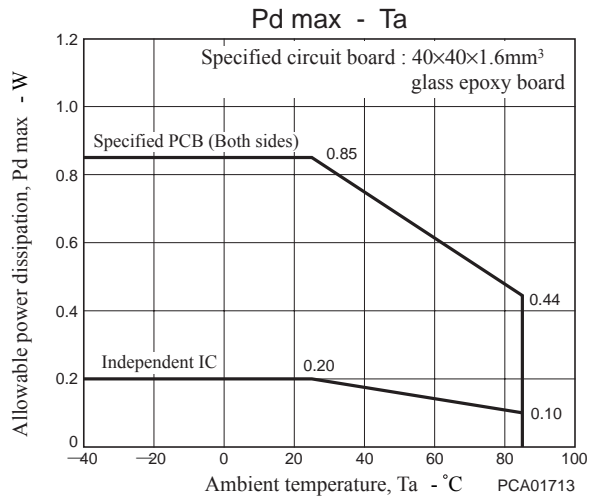
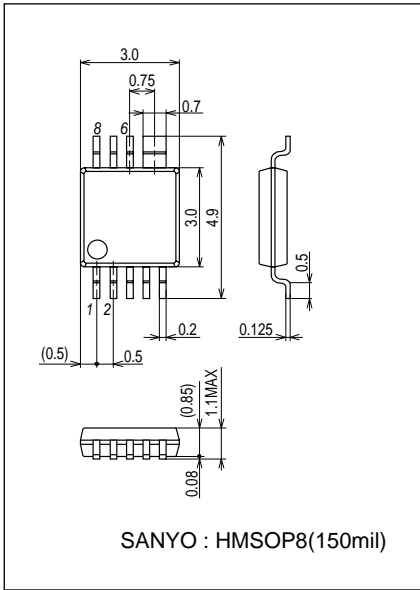

## Evaluation board

Size : 40mmx40mmx1.6mm

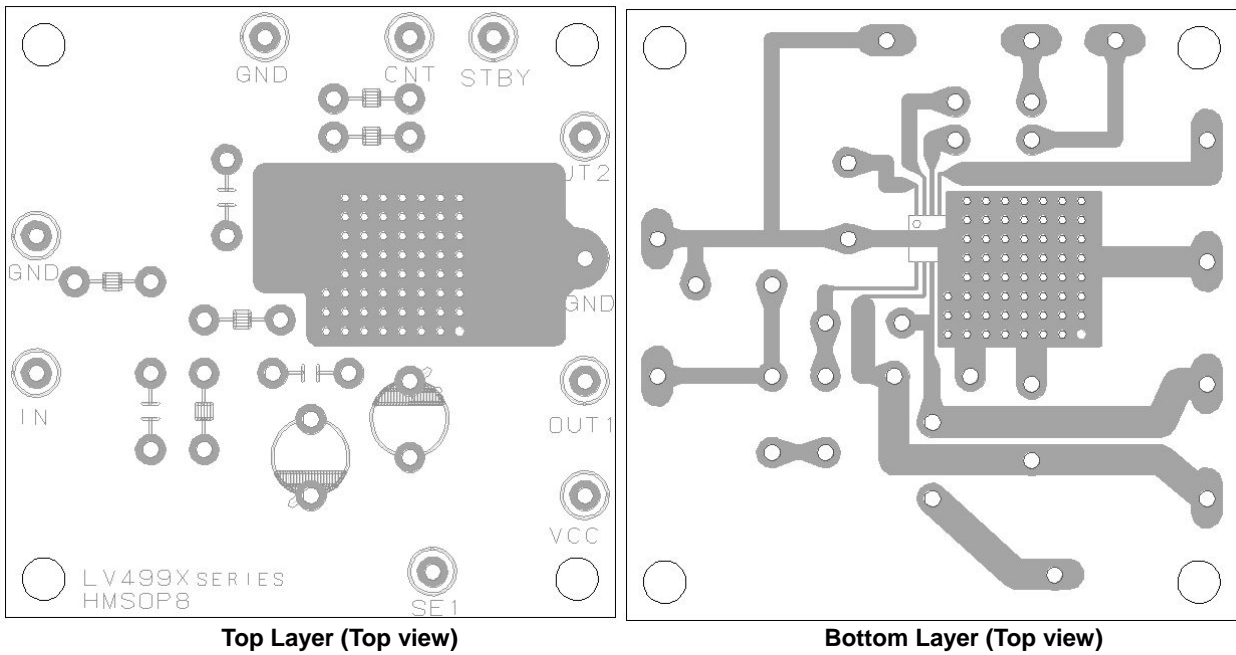

# LV4993TH

## Block Diagram and Sample Application Circuit

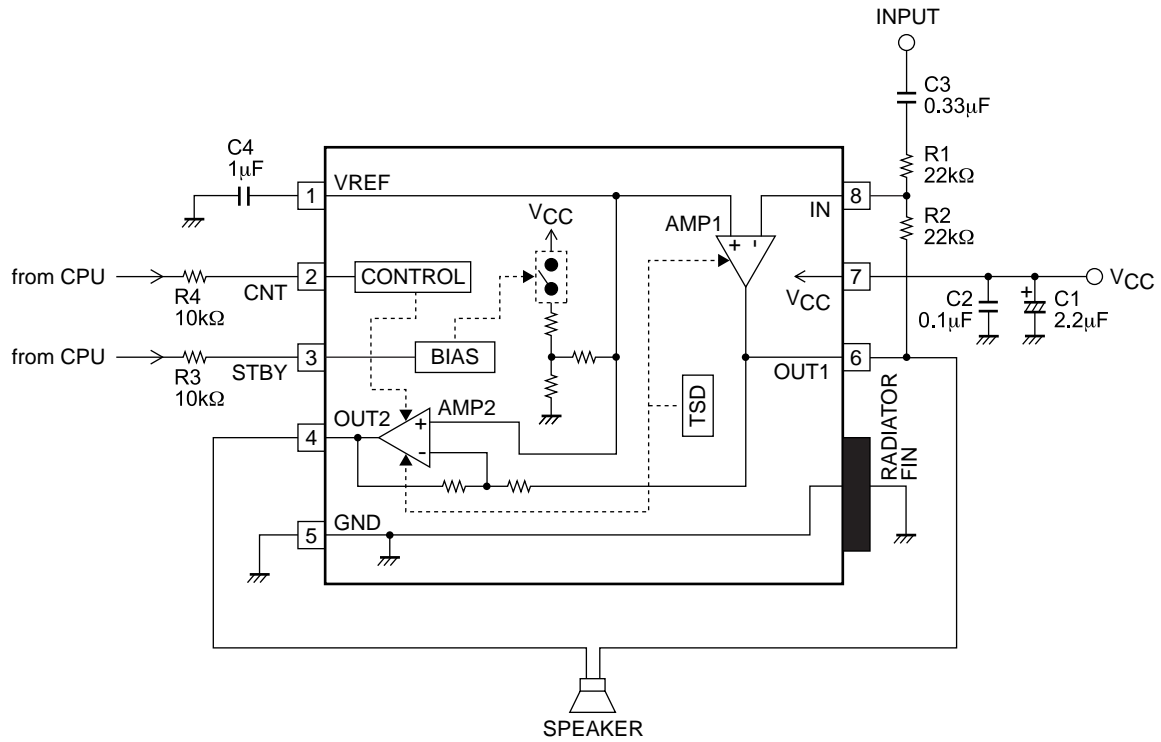

## Test Circuit

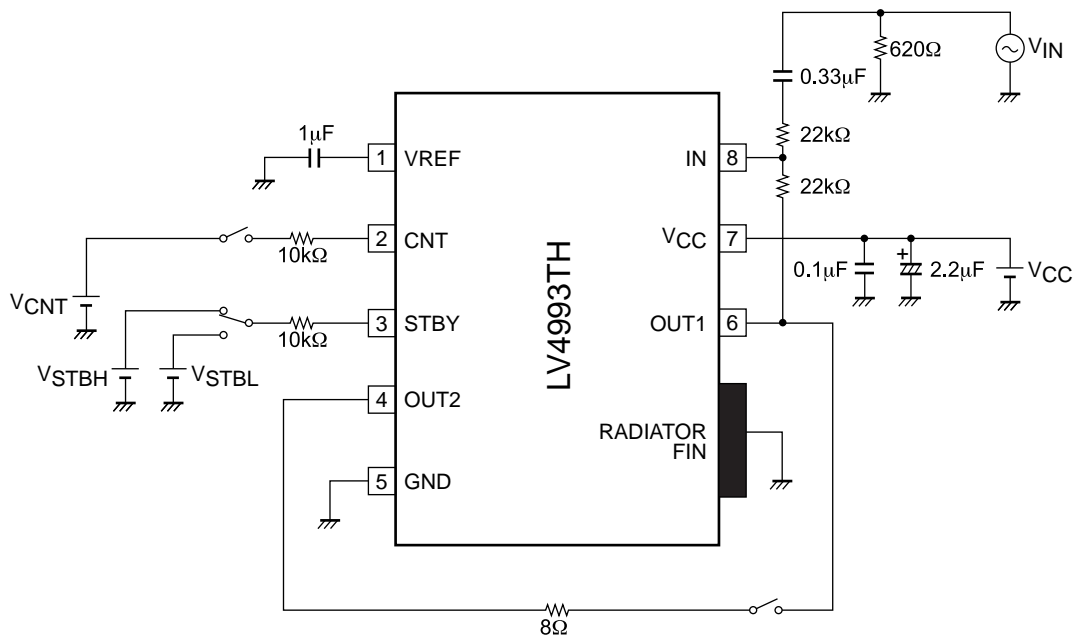

# LV4993TH

## Pin Description

Pin No.	Symbol	Pin voltage	Description	Equivalent circuit
		$V_{CC} = 5V$		
1	VREF	2.5	Standard voltage pin	
2	CNT	1.4	Second amplifier stop control pin •When OPEN : BTL mode •When external is impressed BTL mode at 1.6V to $V_{CC}$ SE mode at 0 to 0.3V	
3	STBY	External impression	Standby control pin •Standby mode at 0 to 0.3V •Operation mode at 1.6 to 3V	
4	OUT2	2.5	Second output pin	
5	GND	0	Ground pin	-
6	OUT1	2.5	First output pin	
7	$V_{CC}$	External impression	Power pin	-
8	IN	2.5	Input pin	

## Cautions for use

### 1. Input coupling capacitor (C3)

C3 is an input coupling capacitor, and it has aimed at the DC cutting. However, please set it in consideration of the cutoff frequency when you decide the capacitance value so that the high-pass filter may be composed by this capacitor (C3) and input resistance (R1), and the bass frequency signal may attenuate.

The cutoff frequency is shown by the next formula.

$$f_c = \frac{1}{2\pi * C3 * R1}$$

Moreover, this capacitor influences a pop noise at start-up. Please note it enough so that the charging time to the capacitor may become long when the value is enlarged, and the pop noise level may grow.

### 2. BTL voltage gain

The voltage gain of the first amplifier is decided depending on the ratio of resistance R1 and R2.

$$V_g = 20 * \log(R2/R1) \text{ (dB)}$$

Therefore, the BTL voltage gain:

$$V_{gBTL} = 6 + 20 * \log(R1/R2) \text{ (dB)}$$

It is shown by the above-mentioned calculating formula. Please set the BTL voltage gain within the range from 0 to 26dB.

### 3. Pin 1 capacitor (C4)

C4 is a capacitor for the ripple filter. It is a purpose to compose the low-pass filter of internal resistance (100kΩ+450kΩ) and C4, to reduce the power supply ripple element, and to improve the ripple elimination factor. Please operate the automatic pop noise reduction circuit by using the standing up transition response characteristic of one pin voltage (standard voltage), and design in IC in consideration of a pop noise at the time of start-up growing when the C3 capacity value is reduced to hasten the start-up speed.

### 4. Capacitor for power supply line (C1, C2)

Bypass capacitor (C2) has aimed at the high frequency aphaeresis that cannot be removed with the power supply capacitor (C1: Chemical capacitor). This capacity must arrange as much as possible near IC, and use the ceramic capacitor with good high-frequency property.

It is also possible to bring it together in the ceramic capacitor of one 2.2μF when a steady power supply is used. Please enlarge the capacity value of power supply capacitor (C1) when the power supply line is comparatively unstable.

### 5. Standby pin (pin 3)

By controlling the standby pin, the mode changeover can be made between standby and operation modes. The series resistance (R3:1kΩ or more) is recommended to be inserted might receive the influence of a digital noise from CPU though it is possible to control with the output port of CPU directly.

Standby mode ⇒ V2 = 0 to 0.3V

Operation mode ⇒ V2 = 1.6 to 3V

Please suppress the impressed voltage to become a static test mode (heat protection circuit operation check mode) when 3V or more is impressed to 3rd pin within 3V. Moreover, it is also possible to synchronize with the power supply and to use the pin as shown in Figure 1 when the standby function is not used. Please set the value of series resistance (R3) so that 3rd pin voltage may become 3V or less.

Current (I3) that flows in 3rd pin can be calculated by the next formula.

$$I_3 = \frac{7 * 10^{-6} + (V_{CC} - 0.7)}{R_3 + 30000}$$

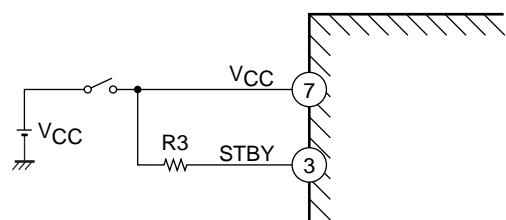

Fig. 1

### 6. Pin 2 control (second amplifier stop control function)

Pin 2 are pin that control ON/OFF as for the movement of the second amplifier of the BTL amplifier. The switch of the speaker drive (BTL output method) and the earphone drive (shingle end output method) can operate by using this function. Moreover, it is possible to use it as a voice mute function in the BTL output method.

Second amplifier ON  $\Rightarrow V_2 = 1.6$  to  $V_{CC}$  or OPEN

Second amplifier OFF  $\Rightarrow V_2 = 0$  to  $0.3V$

Make it to the opening when this function is not used.

### 7. Load capacitance

The phase margin degree of the power amplifier might decrease by the influence of this capacitor when the capacitor is connected by the purpose of the anti-electric wave radiation measures etc. between output pins GND and the oscillation be caused. Note the capacity value when you add this capacitor.

Recommended capacity value: 100pF or less or 1000pF to 1 $\mu$ F

### 8. Thermal protector circuit

The thermal protector circuit is built into in IC, and when heat is abnormally generated because of some causes, the risk of destruction/deterioration can be reduced. The protection circuit operates when junction temperature ( $T_j$ ) of the chip in IC rises to about 165°C, the current supply source to the power amplifier is intercepted, and the signal is not output. It returns automatically if the temperature of the chip decreases (about 140°C). This circuit must note handling enough because it is able surely not to prevent destruction/deterioration. Turn off power promptly when you abnormally generate heat, and pinpoint the cause.

### 9. Short-circuit between pins

When power is applied with pins left short-circuited, deterioration or damage may result.

Therefore, check before power application if pins are short-circuited with solder, etc. during mounting of IC to the substrate.

### 10. Short-circuit of load

If the load is left short-circuited for a long period of time, deterioration or damage may occur.

Never allow the load to short-circuit.

### 11. Maximum rating

When IC is used near the maximum rating, there is a possibility that the maximum rating may be exceeded even under the smallest change of conditions, resulting in failure. Take the sufficient margin for variation of supply voltage and use IC within a range where the maximum rating will never be exceeded.

# LV4993TH

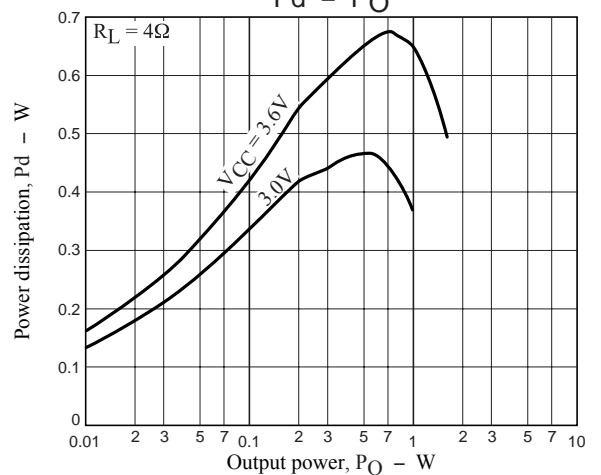
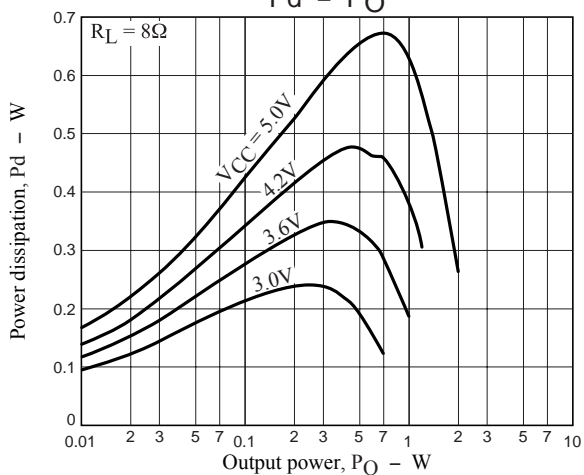
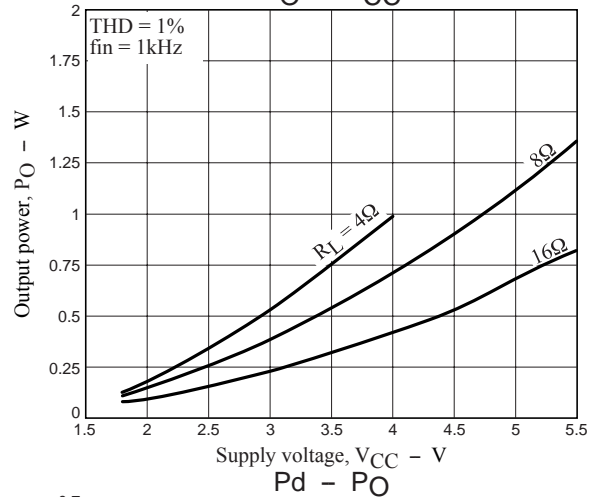
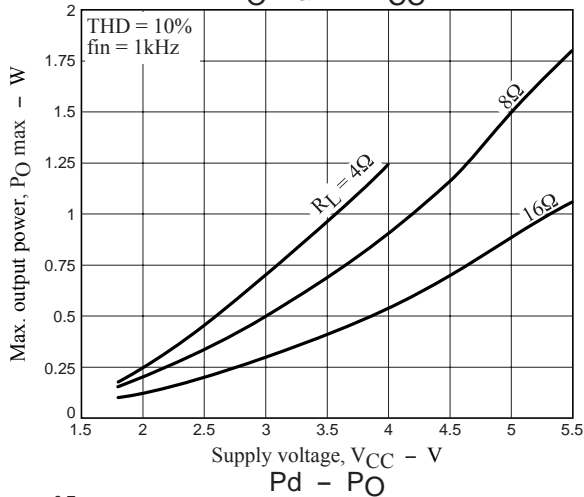
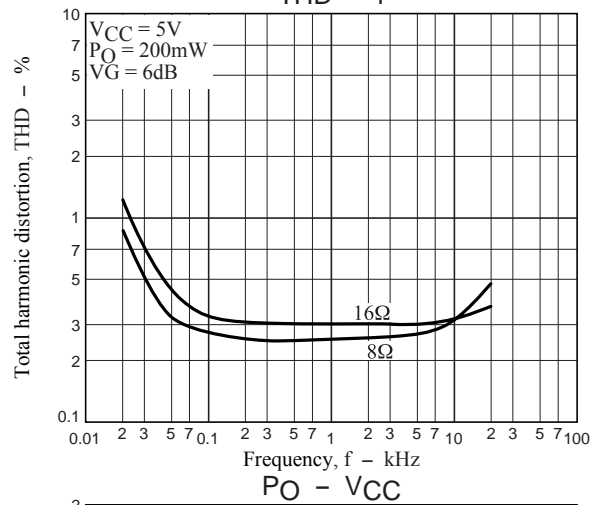
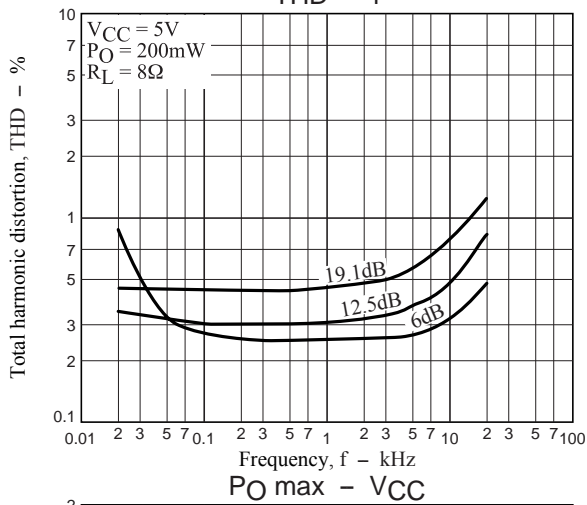
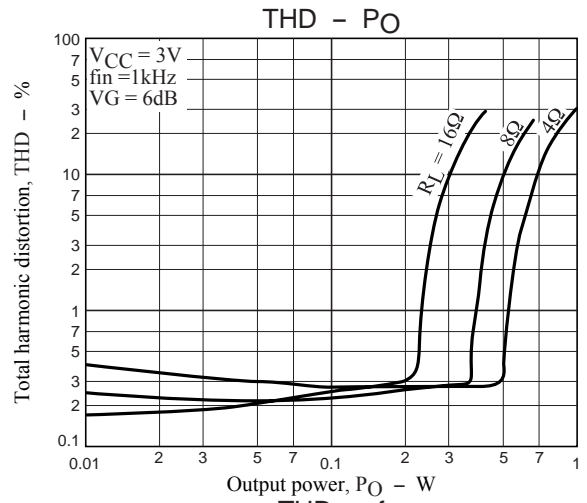
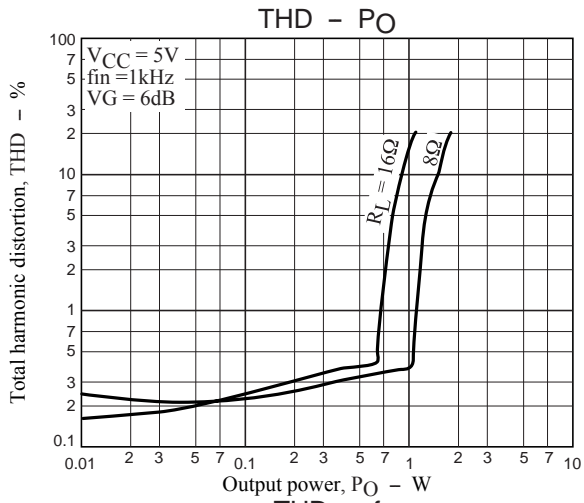



# LV4993TH

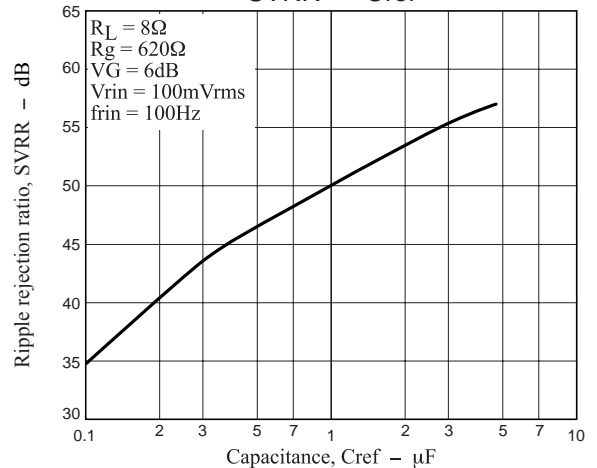
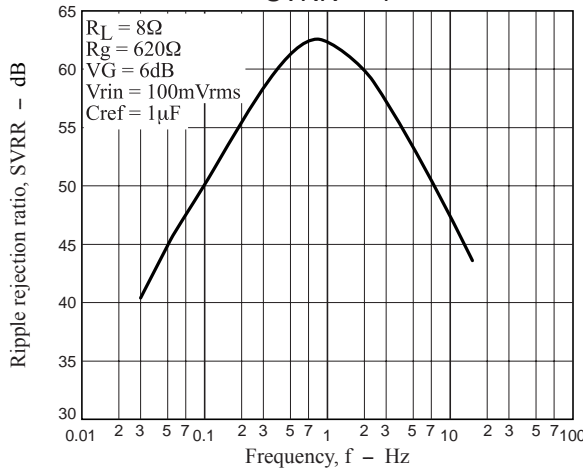
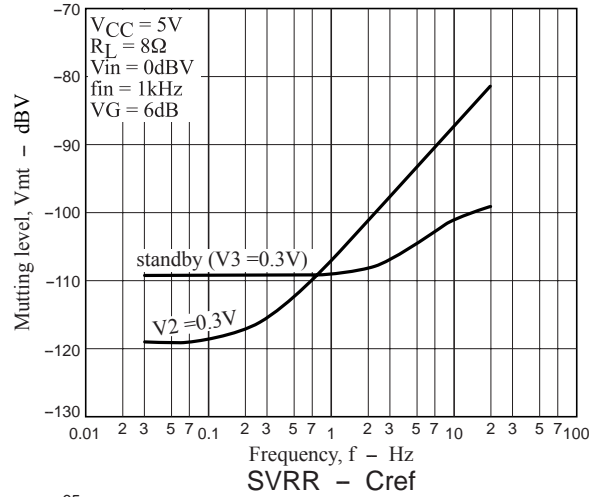
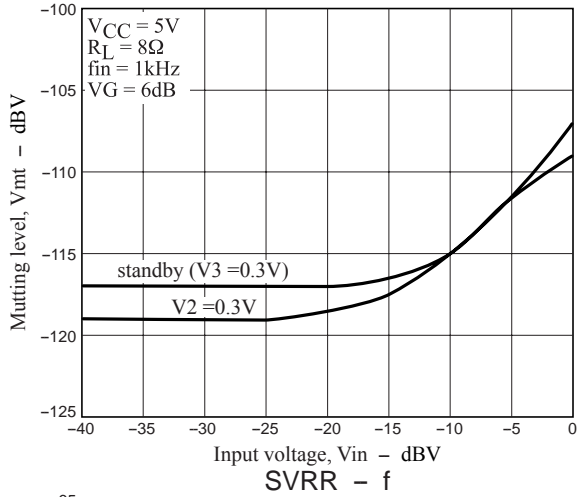
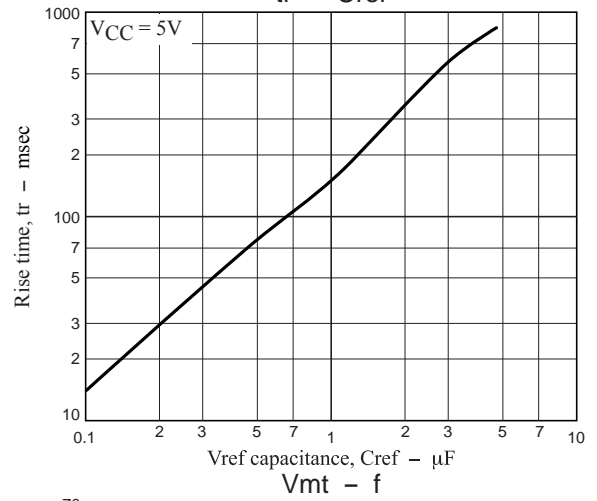
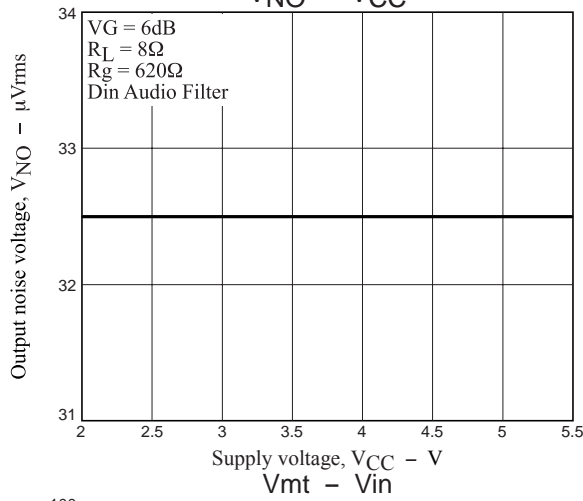
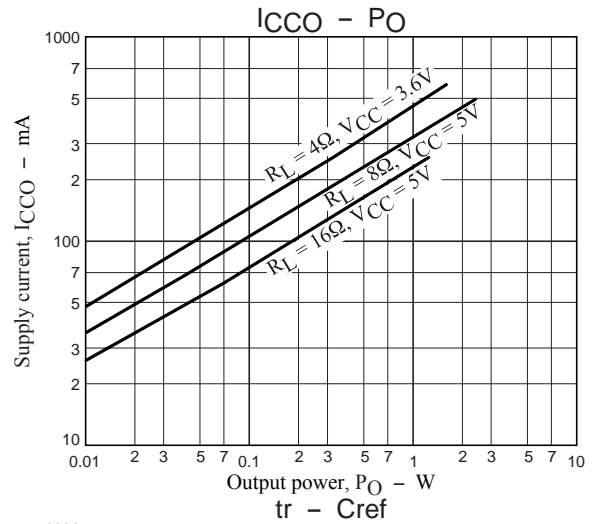
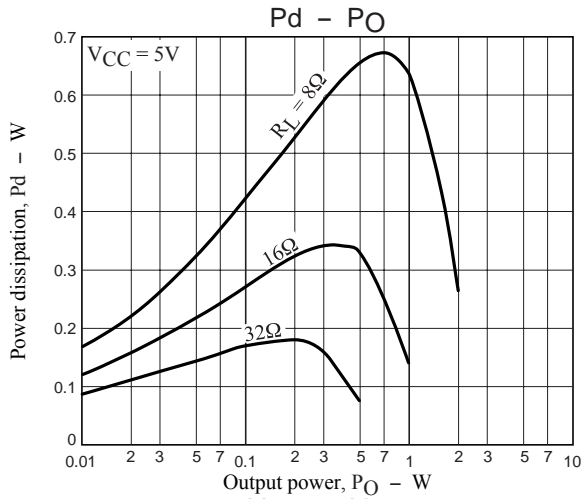

# LV4993TH

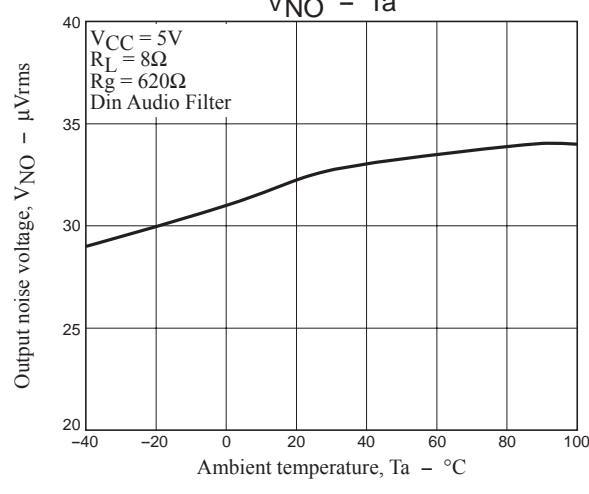
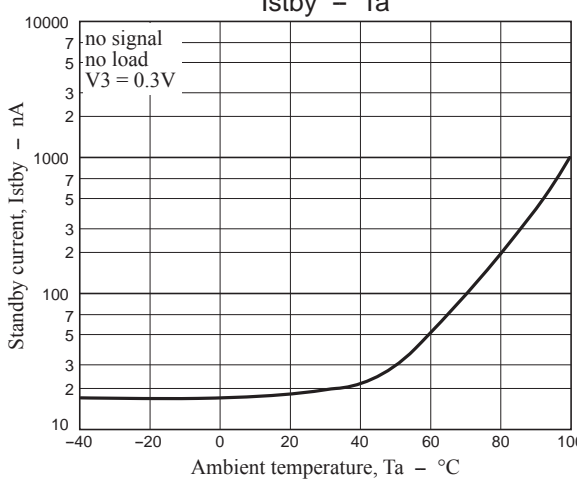
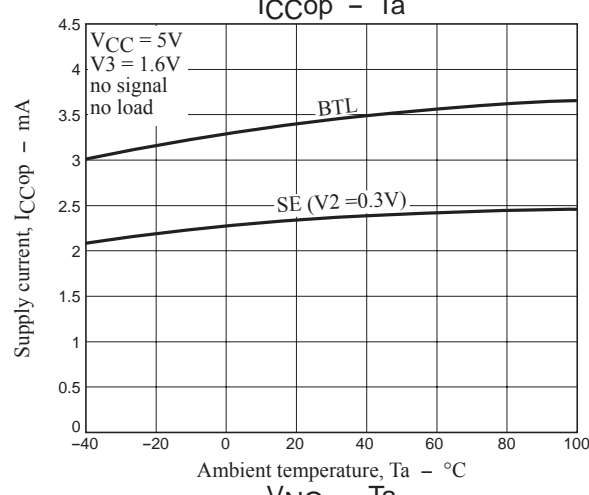
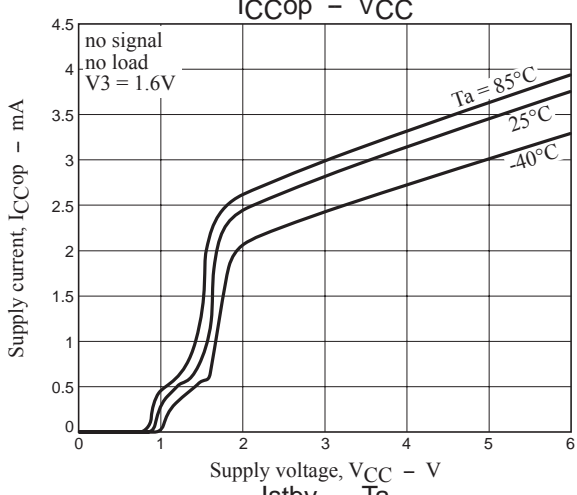
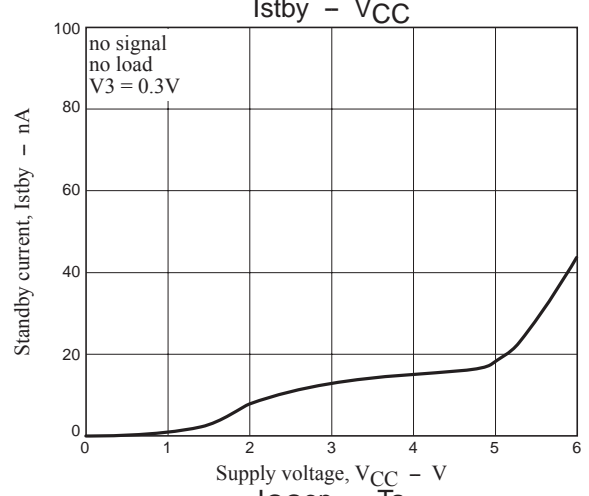
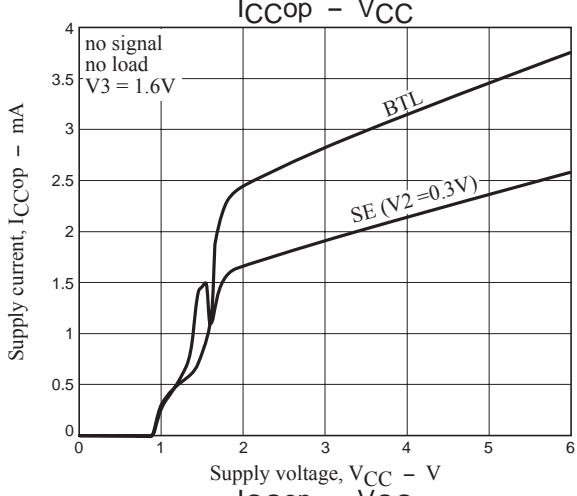
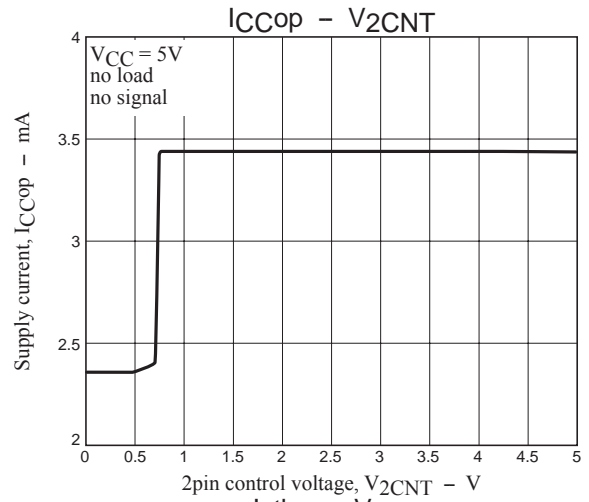
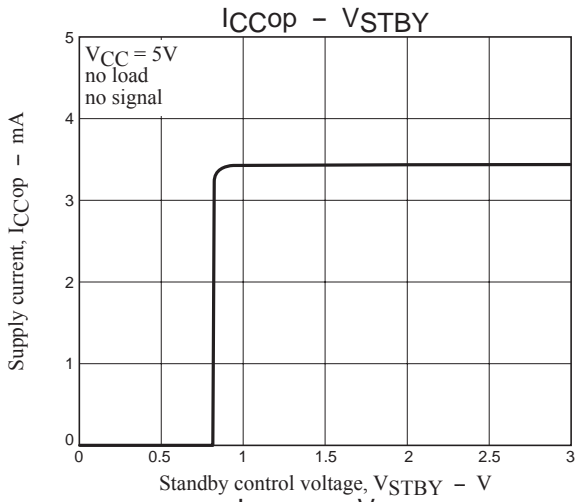

# LV4993TH

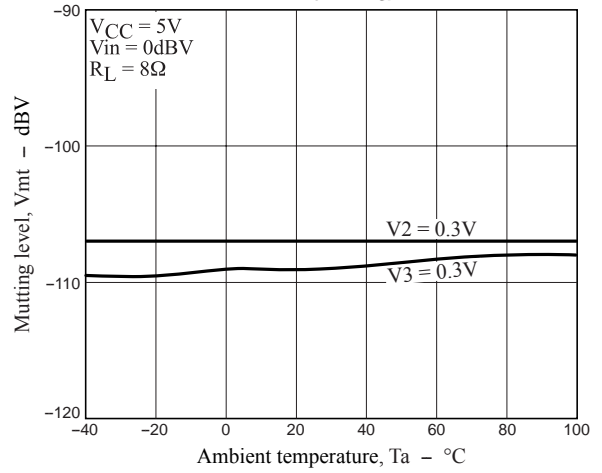
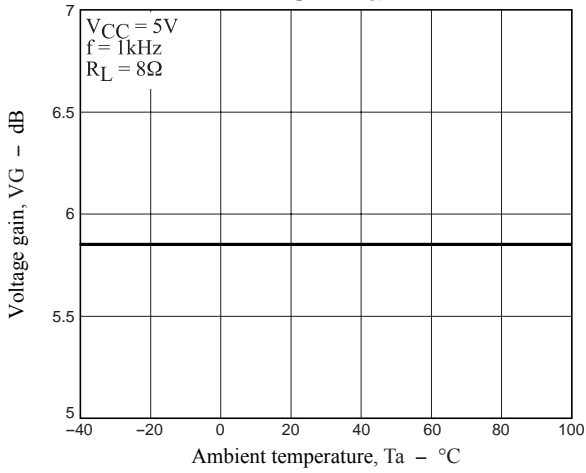
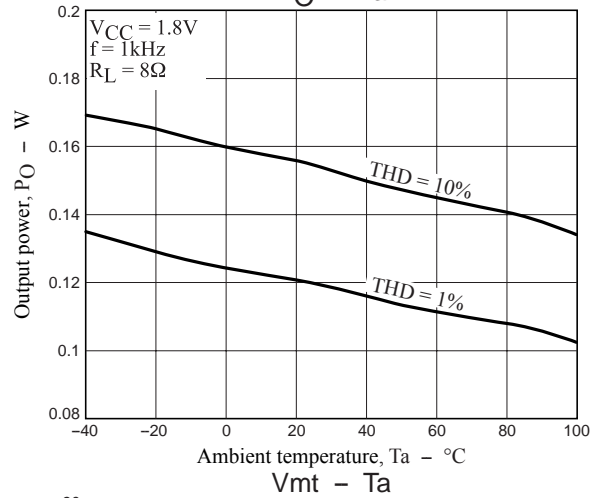
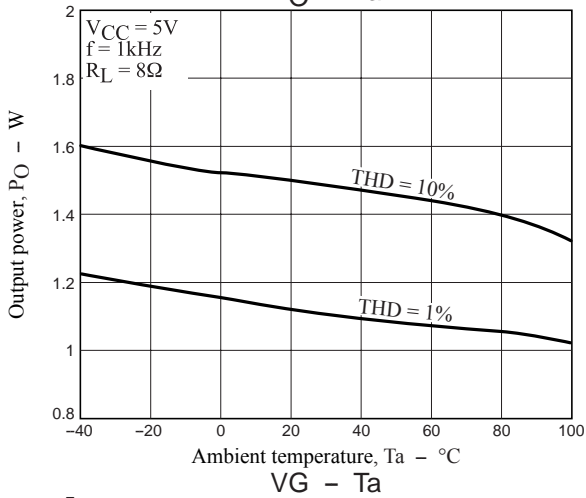
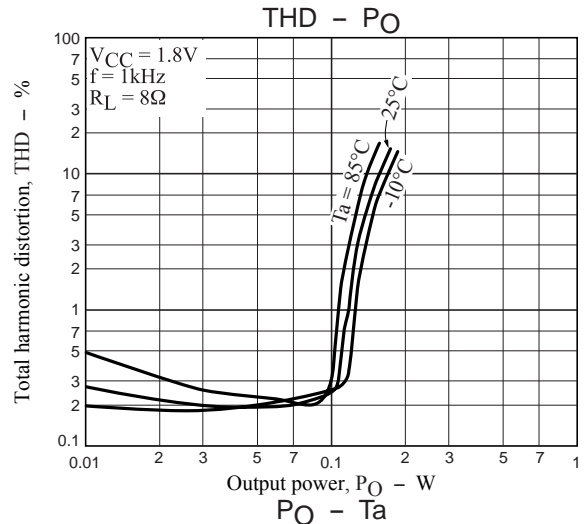
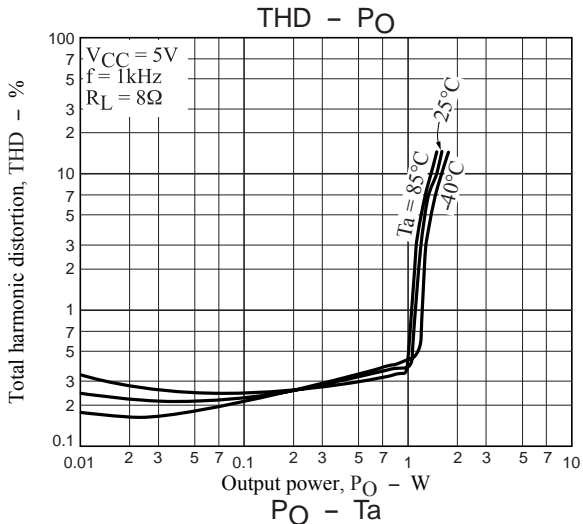

# LV4993TH

## Transient response characteristics

$V_{CC} = 5V$ ,  $R_L = 8\Omega$ ,  $V_G = 6dB$ ,  $C_{ref} = 1\mu F$ ,  $C_{in} = 0.33\mu F$

### Rising Transient response characteristics

CH1:Load end [100mV/div]

CH2:6pin (OUT1) [1V/div]

CH3:3pin (STBY) [2V/div]

Time axis:50msec/div

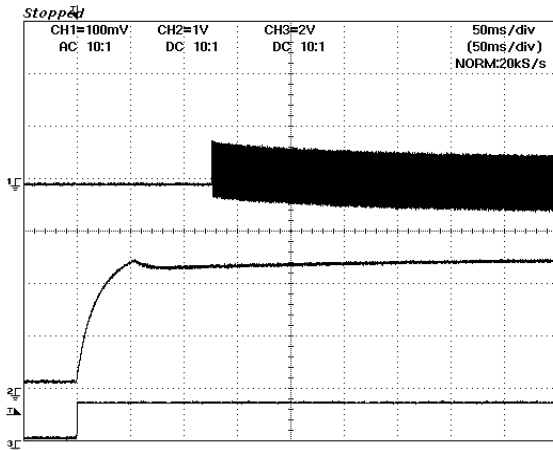

### Falling Transient response characteristics

CH1:Load end [100mV/div]

CH2:6pin (OUT1) [1V/div]

CH3:3pin (STBY) [2V/div]

Time axis:50msec/div

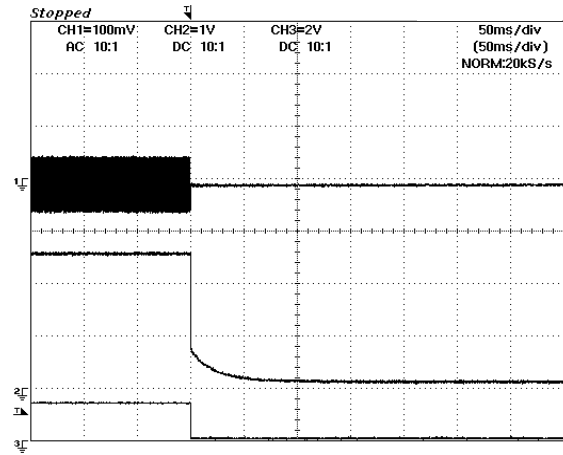

### Mute release Transient response characteristics (ON→OFF)

CH1:Load end [100mV/div]

CH2:6pin (OUT1) [1V/div]

CH3:2pin (CNT) [2V/div]

Time axis:2msec/div

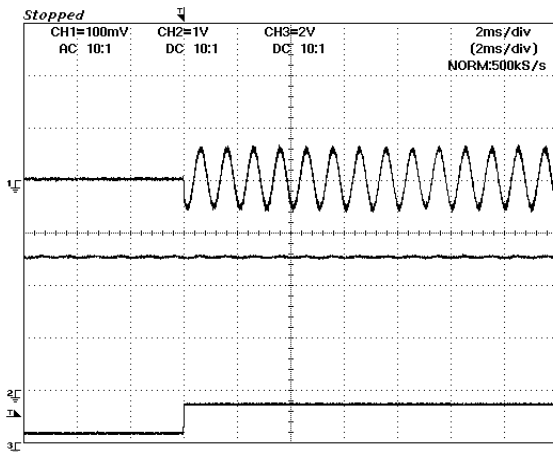

### Mute Transient response characteristics (OFF→ON)

CH1:Load end [100mV/div]

CH2:6pin (OUT1) [1V/div]

CH3:2pin (CNT) [2V/div]

Time axis:2msec/div

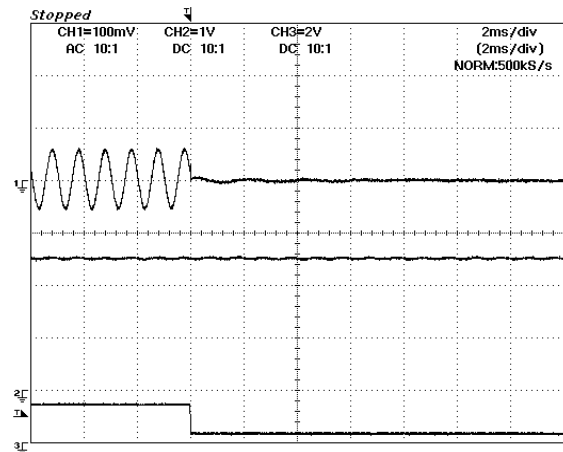

- SANYO Semiconductor Co.,Ltd. assumes no responsibility for equipment failures that result from using products at values that exceed, even momentarily, rated values (such as maximum ratings, operating condition ranges, or other parameters) listed in products specifications of any and all SANYO Semiconductor Co.,Ltd. products described or contained herein.
- SANYO Semiconductor Co.,Ltd. strives to supply high-quality high-reliability products, however, any and all semiconductor products fail or malfunction with some probability. It is possible that these probabilistic failures or malfunction could give rise to accidents or events that could endanger human lives, trouble that could give rise to smoke or fire, or accidents that could cause damage to other property. When designing equipment, adopt safety measures so that these kinds of accidents or events cannot occur. Such measures include but are not limited to protective circuits and error prevention circuits for safe design, redundant design, and structural design.
- In the event that any or all SANYO Semiconductor Co.,Ltd. products described or contained herein are controlled under any of applicable local export control laws and regulations, such products may require the export license from the authorities concerned in accordance with the above law.
- No part of this publication may be reproduced or transmitted in any form or by any means, electronic or mechanical, including photocopying and recording, or any information storage or retrieval system, or otherwise, without the prior written consent of SANYO Semiconductor Co.,Ltd.
- Any and all information described or contained herein are subject to change without notice due to product/technology improvement, etc. When designing equipment, refer to the "Delivery Specification" for the SANYO Semiconductor Co.,Ltd. product that you intend to use.
- Information (including circuit diagrams and circuit parameters) herein is for example only; it is not guaranteed for volume production.
- Upon using the technical information or products described herein, neither warranty nor license shall be granted with regard to intellectual property rights or any other rights of SANYO Semiconductor Co.,Ltd. or any third party. SANYO Semiconductor Co.,Ltd. shall not be liable for any claim or suits with regard to a third party's intellectual property rights which has resulted from the use of the technical information and products mentioned above.

This catalog provides information as of June, 2011. Specifications and information herein are subject to change without notice.