

# 500mA, Synchronous Step-Down DC/DC Converter with Selectable Output Voltage

## FEATURES

- **High Efficiency: Up to 96%**
- **Pin Selectable Output Voltage: 1.28V/1.87V**
- **Low Ripple (<20mV<sub>P-P</sub>) Burst Mode® Operation: I<sub>Q</sub> = 26µA**
- **Very Low Quiescent Current: Only 26µA**
- **2.5V to 5.5V Input Voltage Range**
- **2.25MHz Constant Frequency Operation**
- **Low Dropout Operation: 100% Duty Cycle**
- **No Schottky Diode Required**
- Internal Soft-Start Limits Inrush Current
- Shutdown Mode Draws <1µA Supply Current
- ±2% Output Voltage Accuracy
- Current Mode Operation for Excellent Line and Load Transient Response
- Overtemperature Protected
- Available in 2mm × 2mm 6-Lead DFN

## APPLICATIONS

- Cellular Telephones
- Wireless and DSL Modems
- Digital Cameras
- MP3 Players
- PDAs and Other Handheld Devices

## DESCRIPTION

The LTC<sup>®</sup>3563 is a high efficiency monolithic synchronous buck converter using a constant frequency, current mode architecture. A voltage select input allows the user to program the output voltage to 1.28V or 1.87V. Supply current during operation is only 26µA, dropping to <1µA in shutdown. The 2.5V to 5.5V input voltage range makes the LTC3563 ideally suited for single Li-Ion battery-powered applications. 100% duty cycle provides low dropout operation, extending battery life in portable systems. Internal power switches are optimized to provide high efficiency and eliminate the need for an external Schottky diode.

The switching frequency is internally set at 2.25MHz, allowing the use of small surface mount inductors and capacitors. The LTC3563 is specifically designed to work well with ceramic output capacitors, achieving very low output voltage ripple and a small PCB footprint.

The LTC3563 is configured for the power saving Burst Mode Operation.

LTC, LTC, LT, LTM and Burst Mode are registered trademarks of Linear Technology Corporation. All other trademarks are the property of their respective owners. Protected by U.S. Patents, including 5481178, 6580258, 6304066, 6127815, 6498466, 6611131, 5994885.

## TYPICAL APPLICATION

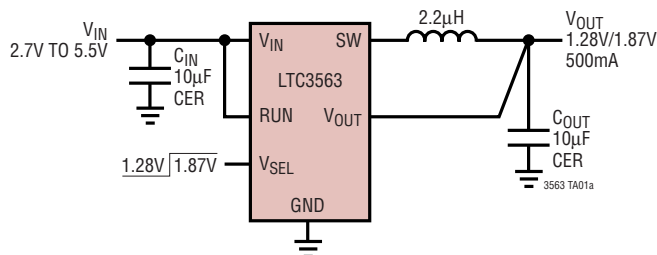

Efficiency and Power Loss vs Output Current

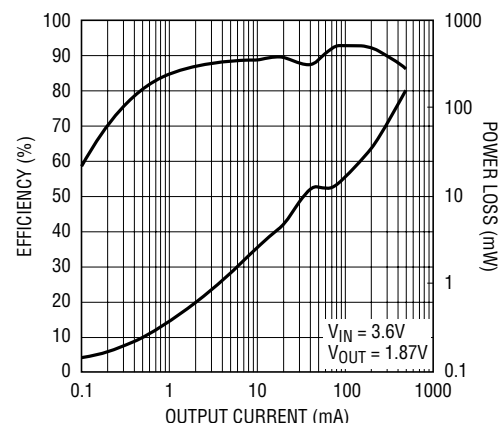

3563 TA01b

3563f

## ABSOLUTE MAXIMUM RATINGS

(Note 1)

Input Supply Voltage ( $V_{IN}$ ) ..... -0.3V to 6V  
 $V_{OUT}$ , RUN Voltages ..... -0.3V to  $V_{IN}$   
 $V_{SEL}$  Voltage ..... -0.3V to ( $V_{IN} + 0.3V$ )  
 SW Voltage ..... -0.3V to ( $V_{IN} + 0.3V$ )

Operating Ambient Temperature Range

(Note 2) ..... -40°C to 85°C

Junction Temperature (Note 7) ..... 125°C

Storage Temperature Range ..... -65°C to 125°C

Reflow Peak Body Temperature (DFN) ..... 260°C

## PACKAGE/ORDER INFORMATION

TOP VIEW

DC PACKAGE  
6-LEAD (2mm × 2mm) PLASTIC DFN

$T_{JMAX} = 125^{\circ}C$ ,  $\theta_{JA} = 102^{\circ}C/W$ ,  $\theta_{JC} = 20^{\circ}C/W$  (SOLDERED TO A 4-LAYER BOARD, NOTE 3)  
EXPOSED PAD (PIN 7) IS PGND, MUST BE SOLDERED TO PCB

ORDER PART NUMBER	DC PART MARKING
LTC3563EDC	LCSZ

**Order Options** Tape and Reel: Add #TR  
 Lead Free: Add #PBF Lead Free Tape and Reel: Add #TRPBF  
 Lead Free Part Marking: <http://www.linear.com/leadfree/>

Consult LTC Marketing for parts specified with wider operating temperature ranges.

## ELECTRICAL CHARACTERISTICS

The ● denotes the specifications which apply over the full operating temperature range, otherwise specifications are at  $T_A = 25^{\circ}C$ .  $V_{IN} = 3.6V$  unless otherwise noted.

SYMBOL	PARAMETER	CONDITIONS	MIN	TYP	MAX	UNITS	
$V_{IN}$	Operating Voltage Range		● 2.5		5.5	V	
$V_{OUT}$	Output Voltage (Note 4)	$V_{SEL} = 0V$	● 1.254	1.28	1.306	V	
		$V_{SEL} = High$	● 1.832	1.87	1.908	V	
$\Delta V_{LINE\_REG}$	Reference Voltage Line Regulation (Note 4)	$V_{IN} = 2.5V$ to $5.5V$		0.04	0.2	%/V	
$\Delta V_{LOAD\_REG}$	Output Voltage Load Regulation (Note 4)	$I_{LOAD} = 100mA$ to $500mA$			0.2	%	
$I_S$	Input DC Supply Current (Note 5)	Active Mode			500	$\mu A$	
		Sleep Mode	$V_{OUT} = 1.1V$ , $V_{SEL} = 0V$		26	35	$\mu A$
		Shutdown	$V_{OUT} = 1.4V$ , $V_{SEL} = 0V$ $RUN = 0V$		0.1	1	$\mu A$
$f_{OSC}$	Oscillator Frequency		● 1.8	2.25	2.7	MHz	
$I_{LIM}$	Peak Switch Current	$V_{IN} = 3V$ , $V_{FB} = 0.5V$ , Duty Cycle < 35%	650	1000	1750	mA	
$R_{DS(ON)}$	P-Channel On Resistance (Note 6) N-Channel On Resistance (Note 6)	$I_{SW} = 100mA$		0.5	0.65	$\Omega$	
		$I_{SW} = 100mA$		0.35	0.55	$\Omega$	
$I_{SW(LKG)}$	Switch Leakage Current	$V_{IN} = 5V$ , $V_{RUN} = 0V$ , $V_{SW} = 0V$ or $5V$		$\pm 0.01$	$\pm 1$	$\mu A$	

## ELECTRICAL CHARACTERISTICS

The ● denotes the specifications which apply over the full operating temperature range, otherwise specifications are at  $T_A = 25^\circ\text{C}$ .  $V_{IN} = 3.6\text{V}$  unless otherwise noted.

SYMBOL	PARAMETER	CONDITIONS	MIN	TYP	MAX	UNITS
$V_{UVLO}$	Undervoltage Lockout Threshold	$V_{IN}$ Rising $V_{IN}$ Falling	1.8	2.0 1.9	2.3	V V
$V_{RUN}$	RUN Threshold		● 0.3		1.2	V
$I_{RUN}$	RUN Leakage Current		●	$\pm 0.01$	$\pm 1$	$\mu\text{A}$
$V_{SEL}$	$V_{SEL}$ Threshold		● 0.3	1	1.2	V
$R_{SEL}$	$V_{SEL}$ Pull-Up Resistance	Resistance Between $V_{SEL}$ and $V_{IN}$	1.3	2.2	3	$\text{M}\Omega$

**Note 1:** Stresses beyond those listed under Absolute Maximum Ratings may cause permanent damage to the device. Exposure to any Absolute Maximum Rating condition for extended periods may affect device reliability and lifetime. No pin should exceed 6V.

**Note 2:** The LTC3563 is guaranteed to meet performance specifications from  $0^\circ\text{C}$  to  $85^\circ\text{C}$ . Specifications over the  $-40^\circ\text{C}$  to  $85^\circ\text{C}$  operating temperature range are assured by design, characterization and correlation with statistical process controls.

**Note 3:** Failure to solder the Exposed Pad of the package to the PC board will result in a thermal resistance much higher than  $40^\circ\text{C}/\text{W}$ .

**Note 4:** The converter is tested in a proprietary test mode that connects the output of the error amplifier to the SW pin, which is connected to an external servo loop.

**Note 5:** Dynamic supply current is higher due to the internal gate charge being delivered at the switching frequency.

**Note 6:** The DFN switch on resistance is guaranteed by correlation to wafer level measurements.

**Note 7:**  $T_J$  is calculated from the ambient temperature  $T_A$  and power dissipation  $P_D$  according to the following formula:

$$T_J = T_A + (P_D) \cdot (\theta_{JA}).$$

## TYPICAL PERFORMANCE CHARACTERISTICS

$T_A = 25^\circ\text{C}$  unless otherwise specified.

### Burst Mode Operation

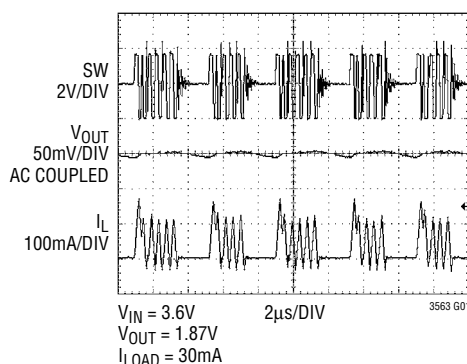

### Start-Up from Shutdown

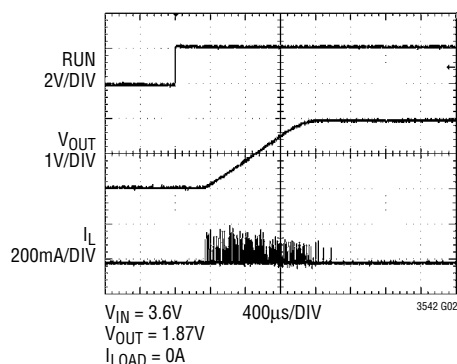

### Start-Up from Shutdown

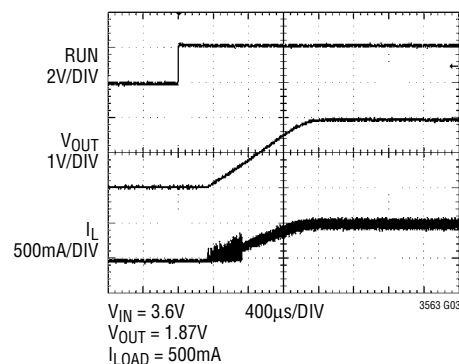

**TYPICAL PERFORMANCE CHARACTERISTICS**  $T_A = 25^\circ\text{C}$  unless otherwise specified.

**Load Step**

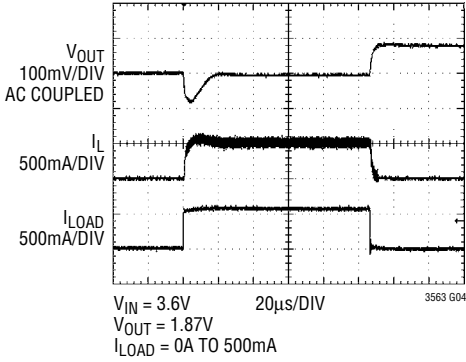

**Load Step**

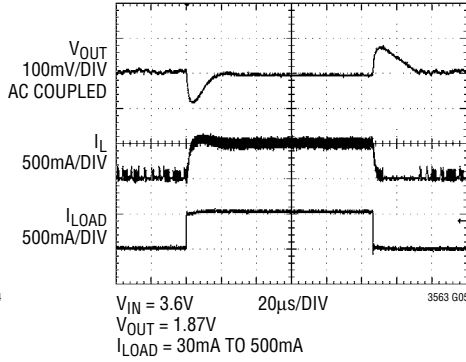

**Load Step**

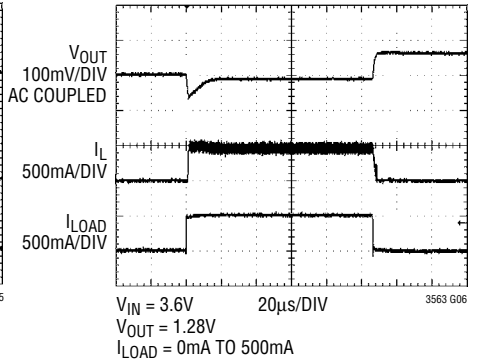

**Load Step**

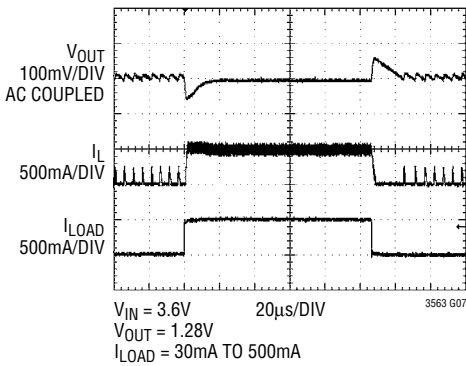

**Regulated Output Voltage vs Temperature**

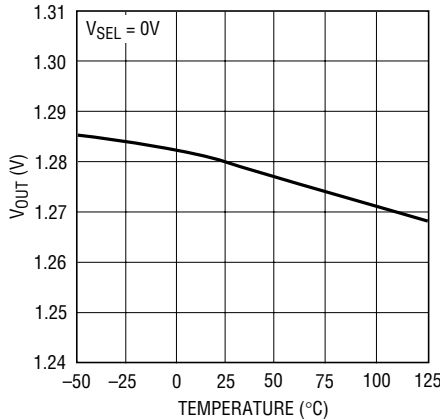

**Oscillator Frequency vs Temperature**

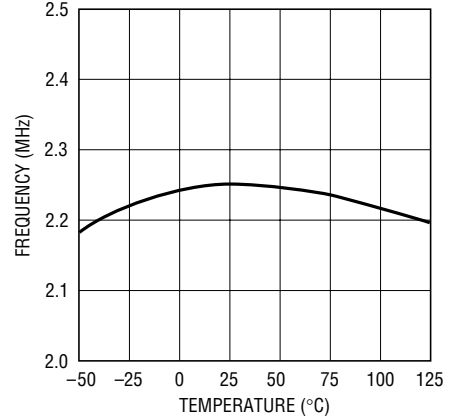

**Oscillator Frequency vs Supply Voltage**

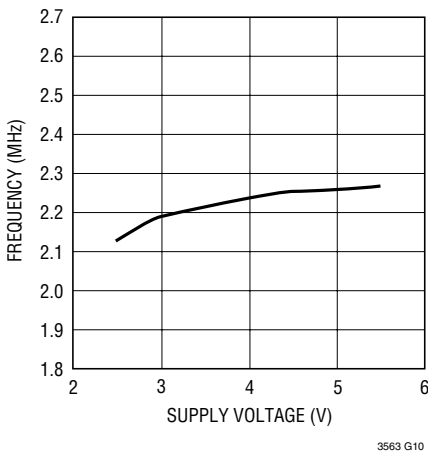

**Output Voltage vs Supply Voltage**

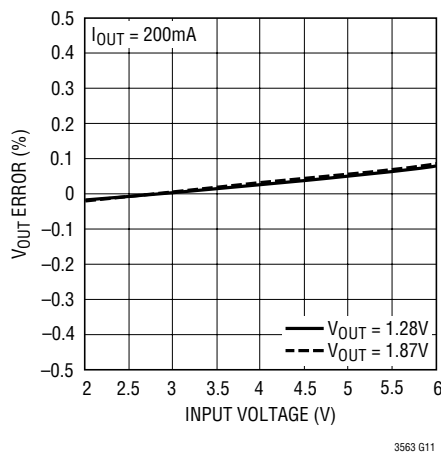

**Output Voltage vs Load Current**

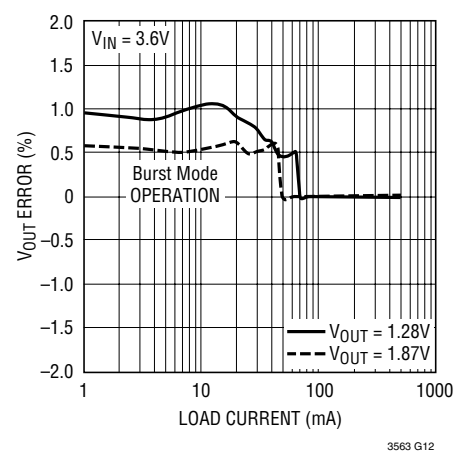

**TYPICAL PERFORMANCE CHARACTERISTICS**  $T_A = 25^\circ\text{C}$  unless otherwise specified.

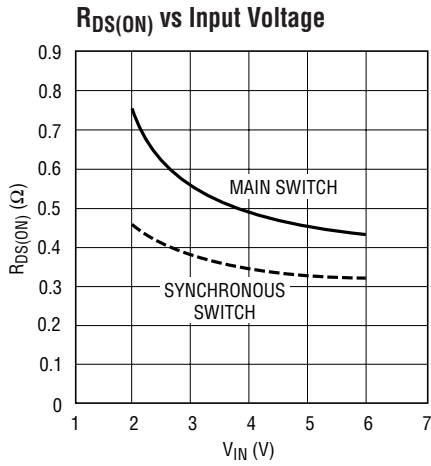

3563 G13

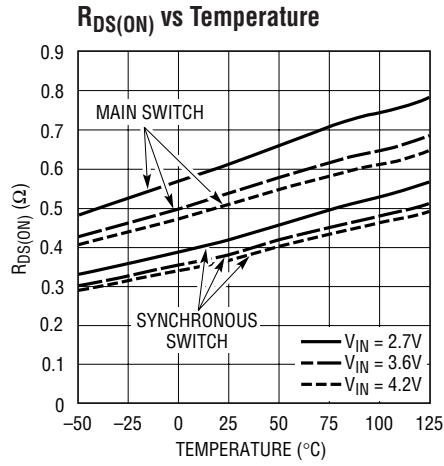

3563 G14

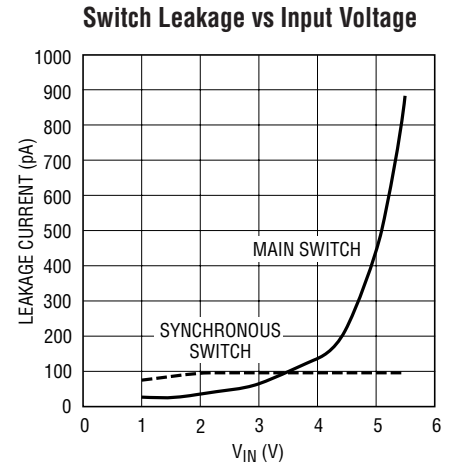

3542 G15

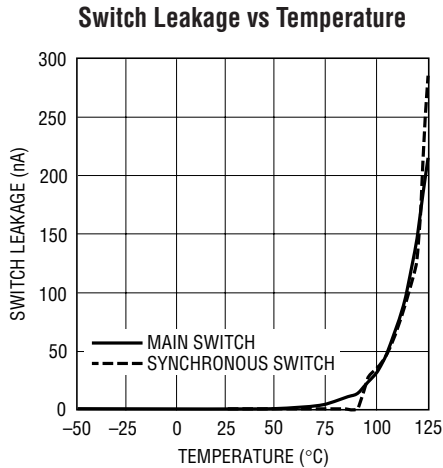

3542 G16

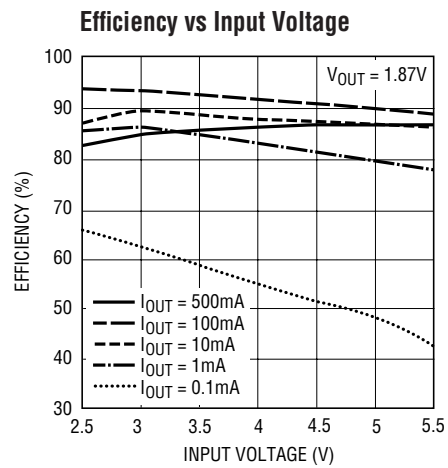

3563 G17

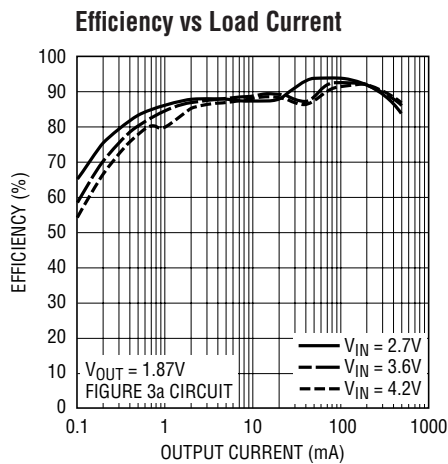

3563 G17

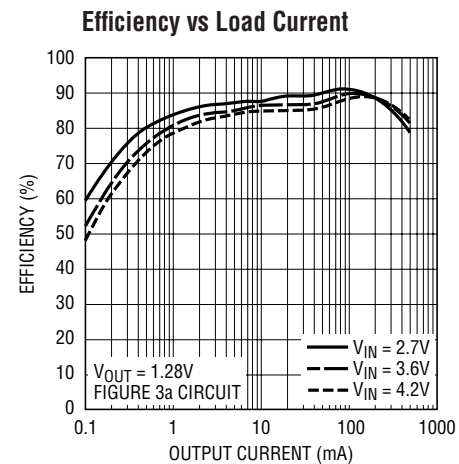

3563 G18

## PIN FUNCTIONS

**V<sub>OUT</sub> (Pin 1):** Output Voltage Feedback. An internal resistive divider divides the output voltage down for comparison to the internal 0.6V reference voltage.

**V<sub>IN</sub> (Pin 2):** Power Supply Pin. Must be closely decoupled to GND.

**GND (Pin 3):** Ground Pin.

**SW (Pin 4):** Switch Node Connection to Inductor. This pin connects to the drains of the internal main and synchronous power MOSFET switches.

**V<sub>SEL</sub> (Pin 5):** Output Voltage Selection Pin. This pin controls the regulated output voltage. When tied to GND, V<sub>OUT</sub> is 1.28V. When floating or connecting this pin to V<sub>IN</sub>, V<sub>OUT</sub> becomes 1.87V.

**RUN (Pin 6):** Converter Enable Pin. Forcing this pin above 1.5V enables this part, while forcing it below 0.3V causes the device to shut down. In shutdown, all functions are disabled drawing <1μA supply current. This pin must be driven; do not float.

**Exposed Pad (Pin 7):** GND. The Exposed Pad is ground. It must be soldered to PCB ground to provide both electrical contact and optimum thermal performance.

**BLOCK DIAGRAM**

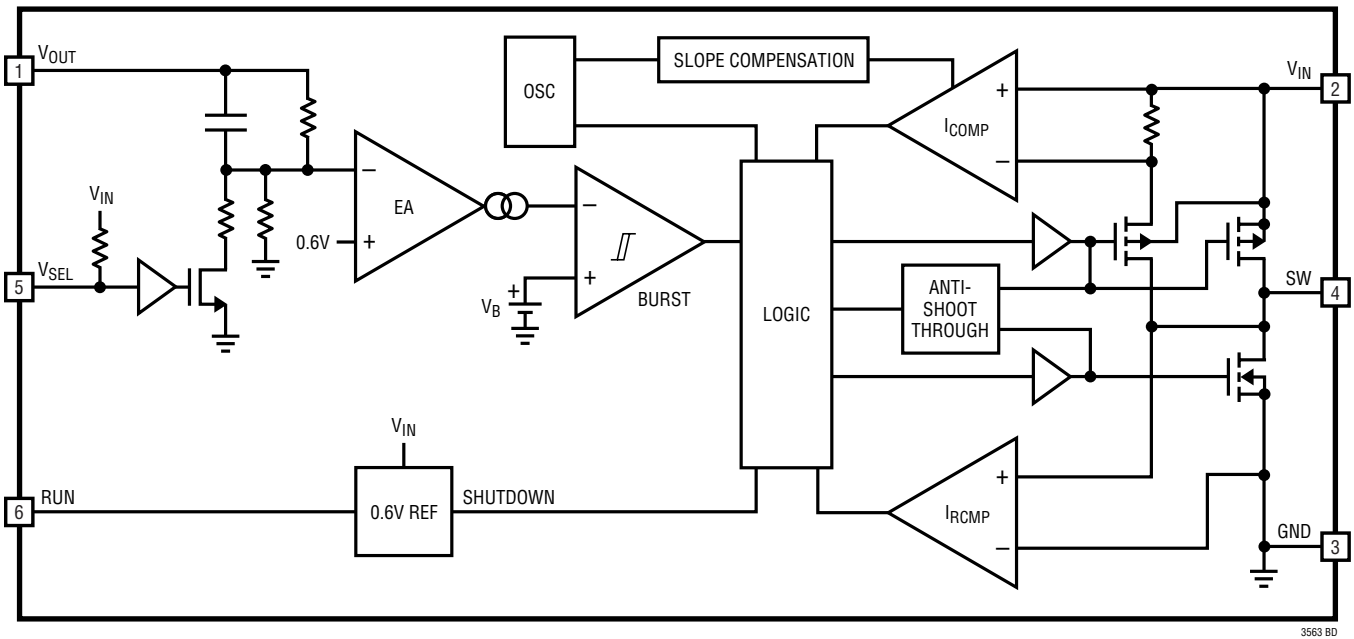

## OPERATION

The LTC3563 uses a constant frequency, current mode, step-down architecture. The operating frequency is set at 2.25MHz.

The output voltage is set by an internal divider. An error amplifier compares the divided output voltage with a reference voltage of 0.6V and adjusts the peak inductor current accordingly.

### Main Control Loop

During normal operation, the top power switch (P-channel MOSFET) is turned on at the beginning of a clock cycle when the  $V_{OUT}$  voltage is below the regulated voltage. The current flows into the inductor and the load increases until the current limit is reached. The switch turns off and energy stored in the inductor flows through the bottom switch (N-channel MOSFET) into the load until the next clock cycle. The peak inductor current is controlled by the internally compensated output of the error amplifier. When the load current increases, the feedback voltage decreases slightly below the reference. This decrease causes the error amplifier to increase its output voltage until the average inductor current matches the new load current. The main control loop is shut down by pulling the RUN pin to ground.

### Burst Mode Operation

During light load currents, the LTC3563 operates in Burst Mode operation in which the internal power MOSFETs operate intermittently based on load demand.

In Burst Mode operation, the peak current of the inductor is set to approximately 60mA regardless of the output load. Each burst event can last from a few cycles at light loads to almost continuously cycling with short sleep intervals at moderate loads. In between these burst events, the power MOSFETs and any unneeded circuitry are turned off, reducing the quiescent current to 26 $\mu$ A. In this sleep state, the load current is being supplied solely from the output capacitor. As the output voltage drops, the EA amplifier's output rises above the sleep threshold and turns the top MOSFET on. This process repeats at a rate that is dependent on the load demand. By running cycles periodically, the switching losses which are dominated by the gate charge losses of the power MOSFETs are minimized.

### Low Supply Operation

To prevent unstable operation, the LTC3563 incorporates an undervoltage lockout circuit which shuts down the part when the input voltage drops below 2V.

### Internal Soft-Start

At start-up when the RUN pin is brought high, the internal reference is linearly ramped from 0V to 0.6V in about 1ms. The regulated output voltage follows this ramp from 0% to 100% in 1ms. The current in the inductor during soft-start is defined by the combination of the current needed to charge the output capacitance and the current provided to the load as the output voltage ramps up. The start-up waveform, shown in the Typical Performance Characteristics, shows the output voltage start-up from 0V to 1.87V with a 500mA load and  $V_{IN} = 3.6V$ .



## APPLICATIONS INFORMATION

A general LTC3563 application circuit is shown in Figure 1. External component selection is driven by the load requirement and begins with the selection of the inductor L. Once the inductor is chosen,  $C_{IN}$  and  $C_{OUT}$  can be selected.

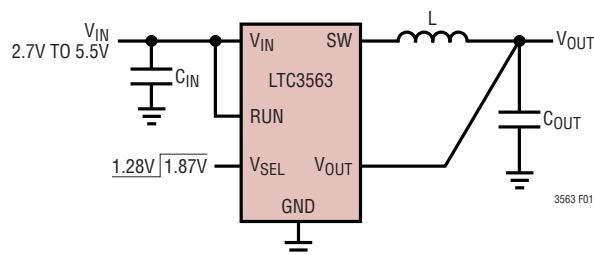

Figure 1. LTC3563 General Schematic

### Inductor Selection

The inductor value has a direct effect on ripple current  $\Delta I_L$ , which decreases with higher inductance and increases with higher  $V_{IN}$  or  $V_{OUT}$ , as shown in following equation:

$$\Delta I_L = \frac{V_{OUT}}{f_0 \cdot L} \left( 1 - \frac{V_{OUT}}{V_{IN}} \right)$$

where  $f_0$  is the switching frequency. A reasonable starting point for setting ripple current is  $\Delta I_L = 0.4 \cdot I_{OUT(MAX)}$ , where  $I_{OUT(MAX)}$  is 500mA. The largest ripple current  $\Delta I_L$  occurs at the maximum input voltage. To guarantee that the ripple current stays below a specified maximum, the inductor value should be chosen according to the following equation:

$$L = \frac{V_{OUT}}{f_0 \cdot \Delta I_L} \left( 1 - \frac{V_{OUT}}{V_{IN(MAX)}} \right)$$

The DC current rating of the inductor should be at least equal to the maximum load current plus half the ripple current to prevent core saturation. Thus, a 600mA rated inductor should be enough for most applications (500mA + 100mA). For better efficiency, choose a low DC-resistance inductor.

The inductor value will also have an effect on Burst Mode operation. The transition to low current operation begins when the inductor's peak current falls below a level set by

the burst clamp. Lower inductor values result in higher ripple current which causes the transition to occur at lower load currents. This causes a dip in efficiency in the upper range of low current operation. In Burst Mode operation, lower inductance values cause the burst frequency to increase.

### Inductor Core Selection

Different core materials and shapes change the size/current and price/current relationships of an inductor. Toroid or shielded pot cores in ferrite or permalloy materials are small and don't radiate much energy, but generally cost more than powdered iron core inductors with similar electrical characteristics. The choice of which style inductor to use often depends more on the price vs size requirements and any radiated field/EMI requirements than on what the LTC3563 requires to operate. Table 1 shows some typical surface mount inductors that work well in LTC3563 applications.

### Input Capacitor ( $C_{IN}$ ) Selection

In continuous mode, the input current of the converter is a square wave with a duty cycle of approximately  $V_{OUT}/V_{IN}$ . To prevent large voltage transients, a low equivalent series resistance (ESR) input capacitor sized for the maximum RMS current must be used. The maximum RMS capacitor current is given by:

$$I_{RMS} \approx I_{MAX} \frac{\sqrt{V_{OUT}(V_{IN} - V_{OUT})}}{V_{IN}}$$

where the maximum average output current  $I_{MAX}$  equals the peak current minus half the peak-to-peak ripple current,  $I_{MAX} = I_{LIM} - \Delta I_L/2$ . This formula has a maximum at  $V_{IN} = 2V_{OUT}$ , where  $I_{RMS} = I_{OUT}/2$ . This simple worst-case is commonly used to design because even significant deviations do not offer much relief. Note that capacitor manufacturer's ripple current ratings are often based on only 2000 hours life time. This makes it advisable to further derate the capacitor, or choose a capacitor rated at a higher temperature than required. Several capacitors may also be paralleled to meet the size or height requirements of the

## APPLICATIONS INFORMATION

Table 1. Representative Surface Mount Inductors

MANUFACTURER	PART NUMBER	VALUE (μH)	MAX DC CURRENT (A)	DCR (Ω)	SIZE (mm <sup>3</sup> )
Sumida	CDRH2D11	2.2	0.780	0.098	3.2 × 3.2 × 1.2
	CDRH3D16	2.2	1.2	0.075	3.8 × 3.8 × 1.8
	CMD4D11	2.2	0.95	0.116	4.4 × 5.8 × 1.2
	CDH2D09B	3.3	0.85	0.15	2.8 × 3 × 1
	CLS4D09	4.7	0.75	0.15	4.9 × 4.9 × 1
Murata	LQH32CN	2.2	0.79	0.097	2.5 × 3.2 × 1.55
	LQH43CN	4.7	0.75	0.15	4.5 × 3.2 × 2.6
TDK	IVLC453232	2.2	0.85	0.18	4.8 × 3.4 × 3.4
	VLF3010AT-2R2M1R0	2.2	1.0	0.12	2.8 × 2.6 × 1

design. An additional 0.1μF to 1μF ceramic capacitor is also recommended on  $V_{IN}$  for high frequency decoupling, when not using an all ceramic capacitor solution.

### Output Capacitor ( $C_{OUT}$ ) Selection

The selection of  $C_{OUT}$  is driven by the required ESR to minimize voltage ripple and load step transients. Typically, once the ESR requirement is satisfied, the RMS current rating generally far exceeds the  $I_{RIPPLE(P-P)}$  requirement, except for an all ceramic solution. The output ripple ( $\Delta V_{OUT}$ ) is determined by:

$$\Delta V_{OUT} \approx \Delta I_L \left( ESR + \frac{1}{8 \cdot f_0 \cdot C_{OUT}} \right)$$

where  $f_0$  is the switching frequency,  $C_{OUT}$  is the output capacitance and  $\Delta I_L$  is the inductor ripple current. For a fixed output voltage, the output ripple is highest at maximum input voltage since  $\Delta I_L$  increases with input voltage.

If tantalum capacitors are used, it is critical that the capacitors are surge tested for use in switching power supplies. An excellent choice is the AVX TPS series of surface mount tantalums, available in case heights ranging from 2mm to 4mm. These are specially constructed and tested for low ESR so they give the lowest ESR for a given volume. Other capacitor types include Sanyo POSCAP, Kemet T510 and

T495 series, and Sprague 593D and 595D series. Consult the manufacturer for other specific recommendations.

### Ceramic Input and Output Capacitors

Higher value, lower cost ceramic capacitors are now becoming available in smaller case sizes. Their high ripple current rating, high voltage rating and low ESR are tempting for switching regulator use. However, the ESR is so low that it can cause loop stability problems. Since the LTC3563's control loop does not depend on the output capacitor's ESR for stable operation, ceramic capacitors can be used to achieve very low output ripple and small circuit size. X5R or X7R ceramic capacitors are recommended because these dielectrics have the best temperature and voltage characteristics of all the ceramics for a given value and size.

Great care must be taken when using only ceramic input and output capacitors. When a ceramic capacitor is used at the input and the power is being supplied through long wires, such as from a wall adapter, a load step at the output can induce ringing at the  $V_{IN}$  pin. At best, this ringing can couple to the output and be mistaken as loop instability. At worst, the ringing at the input can be large enough to damage the part. For more information, see Application Note 88. The recommended capacitance value to use is 10μF for both input and output capacitors.

## APPLICATIONS INFORMATION

### Efficiency Considerations

The efficiency of a switching regulator is equal to the output power divided by the input power times 100%. It is often useful to analyze individual losses to determine what is limiting the efficiency and which change would produce the most improvement. Efficiency can be expressed as:

$$\text{Efficiency} = 100\% - (L1 + L2 + L3 + \dots)$$

where L1, L2, etc. are the individual losses as a percentage of input power.

Although all dissipative elements in the circuit produce losses, three main sources usually account for most of the losses in LTC3563 circuits: 1)  $V_{IN}$  quiescent current, 2)  $I^2R$  loss and 3) switching loss.  $V_{IN}$  quiescent current loss dominates the power loss at very low load currents, whereas the other two dominate at medium to high load currents. In a typical efficiency plot, the efficiency curve at very low load currents can be misleading since the actual power loss is of no consequence as illustrated in Figure 2.

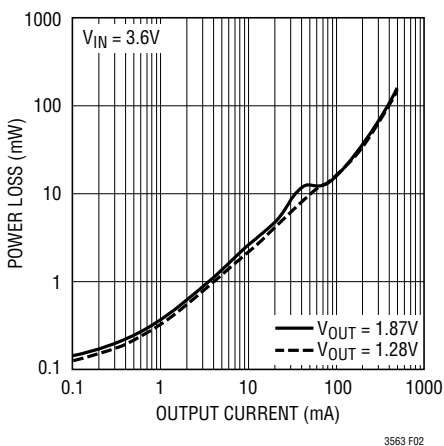

Figure 2. Power Loss vs Load Current

1) The  $V_{IN}$  quiescent current is the DC supply current given in the Electrical Characteristics which excludes MOSFET charging current.  $V_{IN}$  current results in a small (<0.1%) loss that increases with  $V_{IN}$ , even at no load.

2)  $I^2R$  losses are calculated from the DC resistances of the internal switches,  $R_{SW}$ , and external inductor,  $R_L$ . In continuous mode, the average output current flows through inductor L, but is “chopped” between the internal top and bottom switches. Thus, the series resistance looking into the SW pin is a function of both top and bottom MOSFET  $R_{DS(ON)}$  and the duty cycle (D) as follows:

$$R_{SW} = (R_{DS(ON)TOP})(D) + (R_{DS(ON)BOT})(1 - D)$$

The  $R_{DS(ON)}$  for both the top and bottom MOSFETs can be obtained from the Typical Performance Characteristics curves. Thus, to obtain  $I^2R$  losses:

$$I^2R \text{ losses} = I_{OUT}^2(R_{SW} + R_L)$$

3) The switching current is MOSFET gate charging current, that results from switching the gate capacitance of the power MOSFETs. Each time a MOSFET gate is switched from low to high to low again, a packet of charge  $dQ$  moves from  $V_{IN}$  to ground. The resulting  $dQ/dt$  is a current out of  $V_{IN}$  that is typically much larger than the DC bias current. In continuous mode,  $I_{GATECHG} = f_0(Q_T + Q_B)$ , where  $Q_T$  and  $Q_B$  are the gate charges of the internal top and bottom MOSFET switches. The gate charge losses are proportional to  $V_{IN}$  and thus their effects will be more pronounced at higher supply voltages.

Other “hidden” losses such as copper trace and internal battery resistances can account for additional efficiency degradations in portable systems. The internal battery and fuse resistance losses can be minimized by making sure that  $C_{IN}$  has adequate charge storage and very low ESR at the switching frequency. Other losses include diode conduction losses during dead-time and inductor core losses generally account for less than 2% total additional loss.

## APPLICATIONS INFORMATION

### Thermal Considerations

In most applications the LTC3563 does not dissipate much heat due to its high efficiency. But in applications where the LTC3563 is running at high ambient temperature with low supply voltage and high duty cycles, such as in dropout, the heat dissipated may exceed the maximum junction temperature of the part. If the junction temperature reaches approximately 150°C, both power switches will be turned off and the SW node will become high impedance.

To avoid the LTC3563 from exceeding the maximum junction temperature, the user needs to do some thermal analysis. The goal of the thermal analysis is to determine whether the power dissipated exceeds the maximum junction temperature of the part. The temperature rise is given by:

$$T_R = (P_D)(\theta_{JA})$$

where  $P_D$  is the power dissipated by the regulator and  $\theta_{JA}$  is the thermal resistance from the junction of the die to the ambient.

The junction temperature,  $T_J$ , is given by:

$$T_J = T_A + T_R$$

where  $T_A$  is the ambient temperature.

As an example, consider the LTC3563 with an output voltage of 1.87V, an input voltage of 2.7V, a load current of 500mA and an ambient temperature of 70°C. From the typical performance graph of switch resistance, the  $R_{DS(ON)}$  of the P-channel switch at 70°C is approximately 0.7Ω and the  $R_{DS(ON)}$  of the N-channel synchronous switch is approximately 0.4Ω. The duty cycle in this case is approximately 70%.

The series resistance looking into the SW pin is:

$$R_{SW} = 0.7\Omega (0.7) + 0.4\Omega (0.3) = 0.61\Omega$$

Therefore, for the power dissipated by the part is:

$$P_D = I_{LOAD}^2 \cdot R_{SW} = 152.5mW$$

For the DFN package, the  $\theta_{JA}$  is 40°C/W. Thus, the junction temperature of the regulator is:

$$T_J = 70^\circ\text{C} + (0.1525)(40) = 76.1^\circ\text{C}$$

which is below the maximum junction temperature of 125°C.

Note that at higher supply voltages, the junction temperature is lower due to reduced switch resistance ( $R_{DS(ON)}$ ).

### Checking Transient Response

The regulator loop response can be checked by looking at the load transient response. Switching regulators take several cycles to respond to a step in load current. When a load step occurs,  $V_{OUT}$  immediately shifts by an amount equal to  $\Delta I_{LOAD} \cdot ESR$ , where ESR is the effective series resistance of  $C_{OUT}$ .  $\Delta I_{LOAD}$  also begins to charge or discharge  $C_{OUT}$ , generating a feedback error signal used by the regulator to return  $V_{OUT}$  to its steady-state value. During this recovery time,  $V_{OUT}$  can be monitored for overshoot or ringing that would indicate a stability problem.

The output voltage settling behavior is related to the stability of the closed-loop system and will demonstrate the actual overall supply performance. For a detailed explanation of optimizing the compensation components, including a review of control loop theory, refer to Application Note 76.

In some applications, a more severe transient can be caused by switching loads with large (>1μF) bypass capacitors. The discharged bypass capacitors are effectively put in parallel with  $C_{OUT}$ , causing a rapid drop in  $V_{OUT}$ . No regulator can deliver enough current to prevent this problem, if the switch connecting the load has low resistance and is driven quickly. The solution is to limit the turn-on speed of the load switch driver. A Hot Swap™ controller is designed specifically for this purpose and usually incorporates current limit, short circuit protection and soft-start.

### Design Example

As a design example, assume the LTC3563 is used in a single lithium-ion battery-powered cellular phone application. The  $V_{IN}$  will be operating from a maximum of 4.2V down to about 2.7V. The load current requirement is a maximum of 0.5A, but most of the time it will be in standby mode, requiring only 2mA. Efficiency at both low and high load currents is important. Output voltage is either 1.87V or 1.28V.

## APPLICATIONS INFORMATION

With this information we can calculate L using:

$$L = \frac{1}{f \cdot \Delta I_L} \cdot V_{OUT} \cdot \left( 1 - \frac{V_{OUT}}{V_{IN}} \right)$$

Substituting  $V_{OUT} = 1.87V$ ,  $V_{IN} = 4.2V$ ,  $\Delta I_L = 200mA$  and  $f = 2.25MHz$  gives:

$$L = \frac{1.87V}{2.25MHz \cdot 200mA} \cdot \left( 1 - \frac{1.87V}{4.2V} \right) = 2.31\mu H$$

With  $V_{OUT} = 1.28V$

$$L = \frac{1.28V}{2.25MHz \cdot 200mA} \cdot \left( 1 - \frac{1.28V}{4.2V} \right) = 1.98\mu H$$

Choosing a vendor's closest inductor value of  $2.2\mu H$  results in a maximum ripple current of:

For  $V_{OUT} = 1.87V$

$$\Delta I_L = \frac{1.87V}{2.25MHz \cdot 2.2\mu H} \cdot \left( 1 - \frac{1.87V}{4.2V} \right) = 209.6mA$$

For  $V_{OUT} = 1.28V$

$$\Delta I_L = \frac{1.28V}{2.25MHz \cdot 2.2\mu H} \cdot \left( 1 - \frac{1.28V}{4.2V} \right) = 179.8mA$$

$C_{IN}$  will require an RMS current rating of at least  $0.25A \approx I_{LOAD(MAX)}/2$  at temperature and  $C_{OUT}$  will require ESR of less than  $0.2\Omega$ . In most cases, ceramic capacitors will satisfy these requirements. Select  $C_{OUT} = 10\mu F$  and  $C_{IN} = 10\mu F$ .

Figure 3 shows the complete circuit along with its efficiency curve, load step response and recommended layout.

### PC Board Layout Checklist

When laying out the printed circuit board, the following checklist should be used to ensure proper operation of the LTC3563. These items are also illustrated graphically in Figure 3b. Check the following in your layout:

1. The power traces, consisting of the GND trace, the SW trace and the  $V_{IN}$  trace should be kept short, direct and wide.
2. Does the (+) plate of  $C_{IN}$  connect to  $V_{IN}$  as closely as possible? This capacitor provides the AC current to the internal power MOSFETs.
3. Keep the (-) plates of  $C_{IN}$  and  $C_{OUT}$  as close as possible.

Hot Swap is a trademark of Linear Technology Corporation.

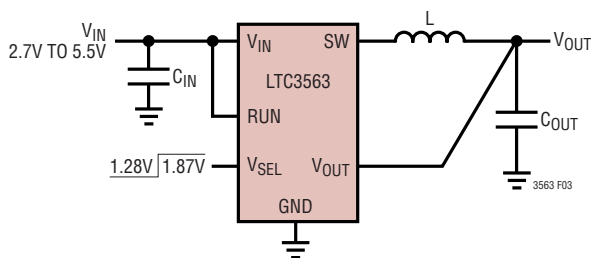

Figure 3a. Typical Application

APPLICATIONS INFORMATION

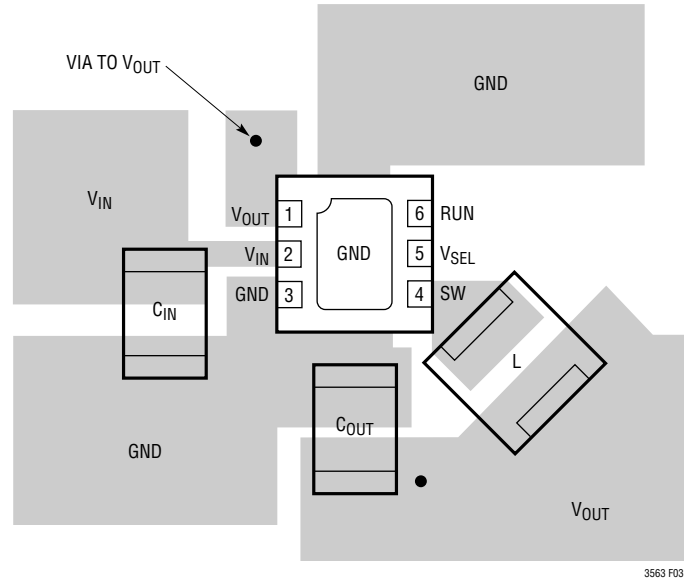

Figure 3b. Layout Diagram

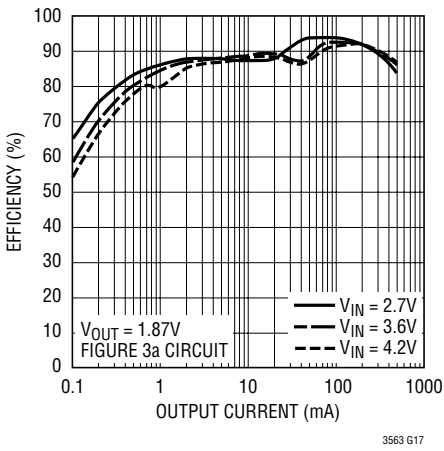

Figure 3c. Efficiency Curve

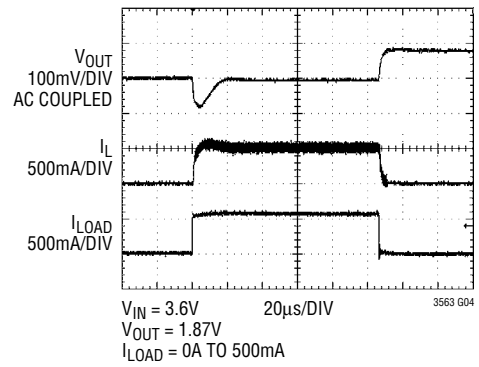

Figure 3d. Load Step





## TYPICAL APPLICATION

### Using Low Profile Components, <1mm Height

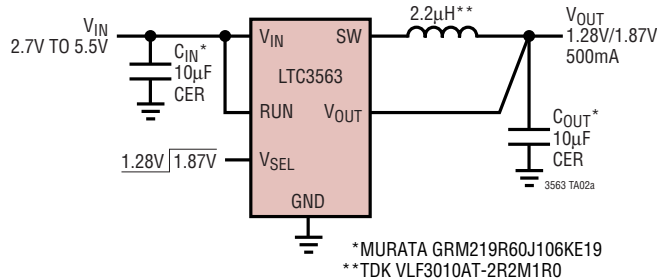

### Efficiency vs Output Current

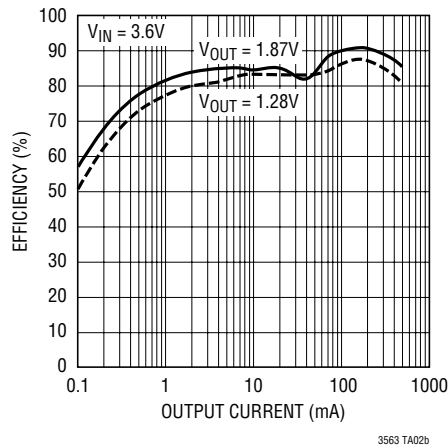

## RELATED PARTS

PART NUMBER	DESCRIPTION	COMMENTS
LTC3405/LTC3405B	300mA I <sub>OUT</sub> , 1.5MHz, Synchronous Step-Down DC/DC Converter	95% Efficiency, V <sub>IN</sub> : 2.5V to 5.5V, V <sub>OUT(MIN)</sub> = 0.8V, I <sub>Q</sub> = 20µA, I <sub>SD</sub> < 1µA, ThinSOT Package
LTC3406/LTC3406B	600mA I <sub>OUT</sub> , 1.5MHz, Synchronous Step-Down DC/DC Converter	96% Efficiency, V <sub>IN</sub> : 2.5V to 5.5V, V <sub>OUT(MIN)</sub> = 0.6V, I <sub>Q</sub> = 20µA, I <sub>SD</sub> < 1µA, ThinSOT Package
LTC3407/LTC3407-2	Dual 600mA/800mA I <sub>OUT</sub> , 1.5MHz/2.25MHz, Synchronous Step-Down DC/DC Converter	95% Efficiency, V <sub>IN</sub> : 2.5V to 5.5V, V <sub>OUT(MIN)</sub> = 0.6V, I <sub>Q</sub> = 40µA, I <sub>SD</sub> < 1µA, MS10E, DFN Packages
LTC3409	600mA I <sub>OUT</sub> , 1.7MHz/2.6MHz, Synchronous Step-Down DC/DC Converter	96% Efficiency, V <sub>IN</sub> : 1.6V to 5.5V, V <sub>OUT(MIN)</sub> = 0.6V, I <sub>Q</sub> = 65µA, I <sub>SD</sub> < 1µA, DFN Package
LTC3410/LTC3410B	300mA I <sub>OUT</sub> , 2.25MHz, Synchronous Step-Down DC/DC Converter	95% Efficiency, V <sub>IN</sub> : 2.5V to 5.5V, V <sub>OUT(MIN)</sub> = 0.8V, I <sub>Q</sub> = 26µA, I <sub>SD</sub> < 1µA, SC70 Package
LTC3411	1.25A I <sub>OUT</sub> , 4MHz, Synchronous Step-Down DC/DC Converter	95% Efficiency, V <sub>IN</sub> : 2.5V to 5.5V, V <sub>OUT(MIN)</sub> = 0.8V, I <sub>Q</sub> = 60µA, I <sub>SD</sub> < 1µA, MS10, DFN Packages
LTC3542	500mA I <sub>OUT</sub> , 2.25MHz, Synchronous Step-Down DC/DC Converter	96% Efficiency, V <sub>IN</sub> : 2.5V to 5.5V, V <sub>OUT(MIN)</sub> = 0.6V, I <sub>Q</sub> = 26µA, I <sub>SD</sub> < 1µA, DFN Packages
LTC3548	Dual 400mA/800mA I <sub>OUT</sub> , 2.25MHz, Synchronous Step-Down DC/DC Converter	95% Efficiency, V <sub>IN</sub> : 2.5V to 5.5V, V <sub>OUT(MIN)</sub> = 0.6V, I <sub>Q</sub> = 40µA, I <sub>SD</sub> < 1µA, MS10, DFN Packages
LTC3561	1A I <sub>OUT</sub> , 4MHz Synchronous Step-Down DC/DC Converter	95% Efficiency, V <sub>IN</sub> : 2.6V to 5.5V, V <sub>OUT(MIN)</sub> = 0.8V, I <sub>Q</sub> = 240µA, I <sub>SD</sub> < 1µA, 3mm × 3mm DFN Package