

FEATURES

- **Low Supply Current: 600 μ A at 3.3V**
- **Supply Current in Shutdown: 0.2 μ A**
- **Supply Current in Receiver Alive Mode: 15 μ A**
- **ESD Protection over ± 10 kV**
- **Operates from a Single 3V to 5.5V Supply**
- Operates to 120kbaud with 0.1 μ F Flying Capacitors
- Three-State Outputs Are High Impedance When Off
- Output Overvoltage Does Not Force Current Back into Supplies
- RS232 I/O Lines Can Be Forced to ± 25 V Without Damage
- Flowthrough Architecture

APPLICATIONS

- Notebook Computers
- Palmtop Computers
- Printers
- Portable Instruments

DESCRIPTION

The LTC[®]1348 is a 3-driver/5-receiver RS232 transceiver with very low supply current. The charge pump only requires five 0.1 μ F capacitors. The LTC1348 provides full RS232 output levels when operated over a wide supply range of 3V to 5.5V

The transceiver operates in one of four modes: Normal, Receiver Disable, Receiver Alive and Shutdown. In Normal or Receiver Disable mode, I_{CC} is only 600 μ A at 3.3V and 800 μ A at 5V in the no load condition. In Shutdown mode, the supply current is further reduced to 0.2 μ A. In Receiver Alive mode, all five receivers are kept alive and the supply current is 15 μ A. All RS232 outputs assume a high impedance state in Shutdown or Receiver Alive mode or with the power off. The receiver outputs assume a high impedance state in Receiver Disable or with the power off.

The LTC1348 is fully compliant with all data rate and overvoltage RS232 specifications. The transceiver operates up to 120kbaud with all drivers loaded with 1000pF, 3k Ω . Both driver outputs and receiver inputs can be forced to ± 25 V without damage and can survive multiple ± 10 kV ESD strikes.

 LTC and LT are registered trademarks of Linear Technology Corporation.

TYPICAL APPLICATION

3-Drivers/5-Receivers with Shutdown

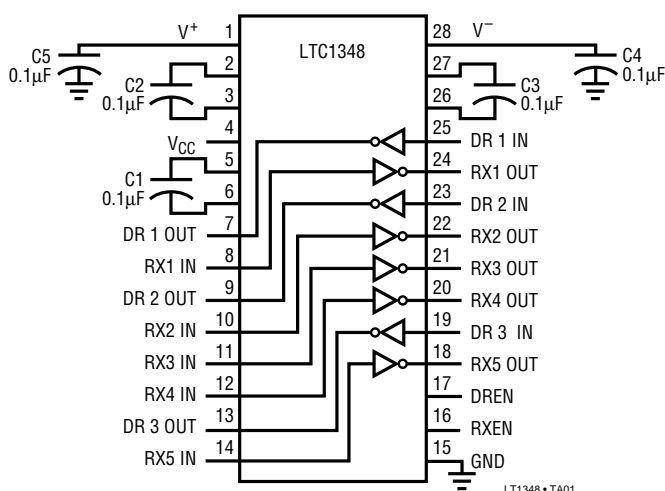

LT1348 • TA01

Supply Current

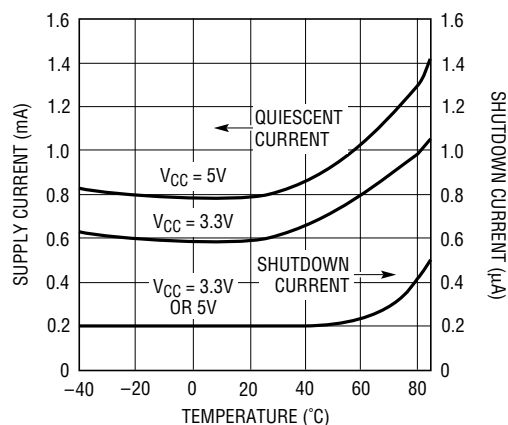

LT1348 • TA02

ABSOLUTE MAXIMUM RATINGS

(Note 1)

Supply Voltage (V_{CC})	6V
Input Voltage	
Driver	-0.3V to $V_{CC} + 0.3V$
Receiver	-25V to 25V
Driver/Receiver Enable Pin	-0.3V to $V_{CC} + 0.3V$
Output Voltage	
Driver	-25V to 25V
Receiver	-0.3V to $V_{CC} + 0.3V$
Short-Circuit Duration	
V^+	30 sec
V^-	30 sec
Driver Output	Indefinite
Receiver Output	Indefinite
Operating Temperature Range	
LTC1348C	0°C to 70°C
LTC1348I	-40°C to 85°C
Storage Temperature Range	-65°C to 150°C
Lead Temperature (Soldering, 10 sec)	300°C

PACKAGE/ORDER INFORMATION

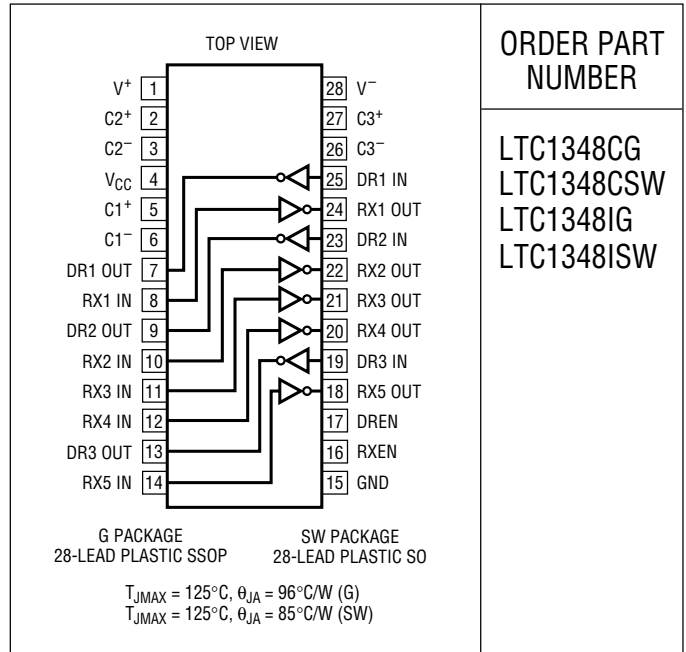

ORDER PART NUMBER

LTC1348CG
LTC1348CSW
LTC1348IG
LTC1348ISW

Consult factory for Military grade parts.

DC ELECTRICAL CHARACTERISTICS

$V_{CC} = 3V$ to $5.5V$, $C1$ to $C4 = 0.1\mu F$, unless otherwise noted.

PARAMETER	CONDITIONS	MIN	TYP	MAX	UNITS
Any Driver					
Output Voltage Swing	$V_{CC} = 3.3V$, 3k to GND Positive Negative	5.0 -5.0	6.2 -6.0		V V
Logic Input Voltage Level	Input Low Level ($V_{OUT} = \text{High}$) Input High Level ($V_{OUT} = \text{Low}$), $V_{CC} = 3.3V$ Input High Level ($V_{OUT} = \text{Low}$), $V_{CC} = 5V$			0.8	V V V
Logic Input Current	$V_{IN} = V_{CC}$ $V_{IN} = 0V$			5 -5	μA μA
Output Short-Circuit Current	$V_{OUT} = 0V$		± 12		mA
Output Leakage Current	Shutdown (Note 3) or Receiver Alive Mode (Note 4), $V_{OUT} = \pm 20V$		± 10	± 500	μA
Any Receiver					
Input Voltage Thresholds	Input Threshold (Receiver Alive Mode) Input Low Threshold (Normal Mode) Input High Threshold (Normal Mode)	0.8 0.8	1.5 1.3 1.7	2.4 2.4	V V V
Hysteresis	Normal Mode		0.3		V
Input Resistance	$V_{IN} = \pm 10V$	3	5	7	k Ω
Output Voltage	Output Low, $I_{OUT} = -1.6mA$ Output High, $I_{OUT} = 160\mu A$		0.2	0.4	V V
Output Short-Circuit Current	Sinking Current, $V_{OUT} = V_{CC}$	-3	-20		mA
Output Leakage Current	Shutdown (Note 3), $0V \leq V_{OUT} \leq V_{CC}$		1	10	μA

DC ELECTRICAL CHARACTERISTICS

$V_{CC} = 3V$ to $5.5V$, $C1$ to $C4 = 0.1\mu F$, unless otherwise noted.

PARAMETER	CONDITIONS	MIN	TYP	MAX	UNITS
Power Supply Generator					
V ⁺ Output Voltage	$I_{OUT} = 0mA$		8.0		V
	$I_{OUT} = 8mA$		7.5		V
V ⁻ Output Voltage	$I_{OUT} = 0mA$		-8.0		V
	$I_{OUT} = -8mA$		-7.0		V
Supply Rise Time	Shutdown to Turn-On		0.2		ms
Power Supply					
V _{CC} Supply Current	No Load (Note 2) $V_{CC} = 3.3V$	●	0.6	2.0	mA
	No Load (Note 2) $V_{CC} = 5V$	●	0.8	2.5	mA
	Receiver Alive Mode (Note 4) $V_{CC} = 3.3V$ or $5V$	●	15	30	μA
Supply Leakage Current (V_{CC})	Shutdown (Note 3)	●	0.2	10	μA
Driver/Receiver Enable Threshold Low		●		0.8	V
Driver/Receiver Enable Threshold High	$V_{CC} = 3.3V$	●	2.0		V
Driver/Receiver Enable Threshold High	$V_{CC} = 5V$	●	2.4		V

AC ELECTRICAL CHARACTERISTICS

$V_{CC} = 3V$ to $5.5V$, $C1$ to $C4 = 0.1\mu F$, unless otherwise noted.

PARAMETER	CONDITIONS	MIN	TYP	MAX	UNITS
Maximum Data Rate	$R_L = 3k$, $C_L = 1000pF$, One Driver Switching	120	250		kbps
Slew Rate	$V_{CC} = 5V$, $R_L = 3k$, $C_L = 51pF$		8	30	$V/\mu s$
	$V_{CC} = 3.3V$, $R_L = 3k$, $C_L = 2500pF$	3			$V/\mu s$
Driver Propagation Delay (TTL to RS232)	t_{HLD} (Figure 1)	●	2.5	4	μs
	t_{LHD} (Figure 1)	●	2.5	4	μs
Receiver Propagation Delay (RS232 to TTL)	t_{HLR} (Figure 2) (Normal Mode)	●	0.3	1	μs
	t_{LHR} (Figure 2) (Normal Mode)	●	0.2	1	μs
	t_{HLR} (Figure 2) (Receiver Alive Mode)	●	1.0	4	μs
	t_{LHR} (Figure 2) (Receiver Alive Mode)	●	0.2	4	μs

The ● denotes specifications which apply over the full operating temperature range ($0^\circ C \leq T_A \leq 70^\circ C$ for Commercial grade and $-40^\circ C \leq T_A \leq 85^\circ C$ for Industrial grade).

Note 1: Absolute Maximum Ratings are those values beyond which the life of the device may be impaired.

Note 2: Supply current is measured with driver and receiver outputs unloaded. The V_{DREN} and $V_{RXEN} = V_{CC}$.

Note 3: Supply current measurement in Shutdown is performed with V_{DREN} and $V_{RXEN} = 0V$.

Note 4: Supply current measurement in Receiver Alive mode is performed with $V_{DREN} = 0V$ and $V_{RXEN} = V_{CC}$.

TYPICAL PERFORMANCE CHARACTERISTICS

Driver Output Voltage High/Low vs Load Capacitance (C_L)

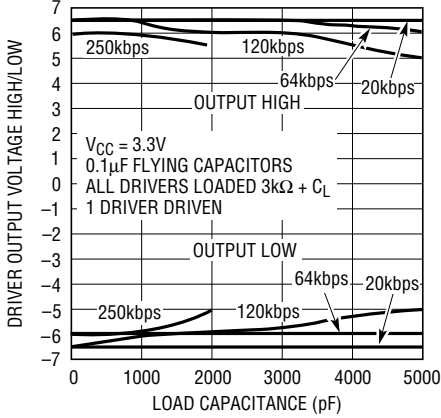

LTC1348 G01

Driver Output Voltage High/Low vs Load Capacitance (C_L)

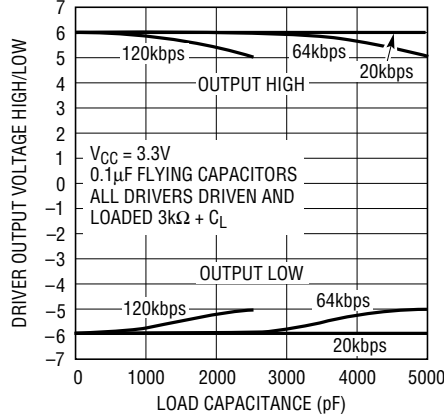

LTC1348 G02

Supply Current vs Driver Data Rate

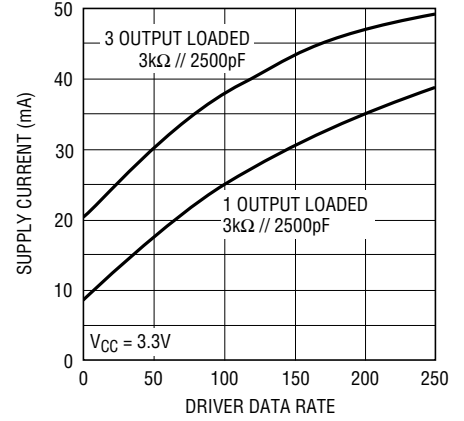

LTC1348 G03

Driver Output Voltage High/Low vs Temperature ($^{\circ}C$)

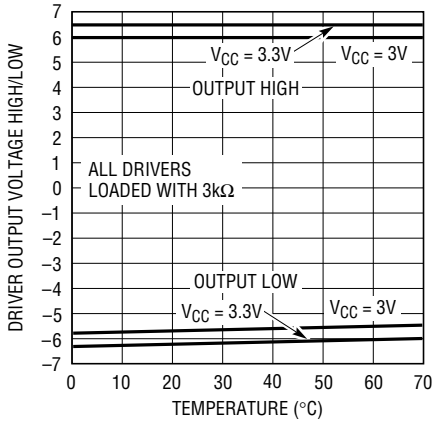

LTC1348 G04

Driver Short-Circuit Current vs Temperature ($^{\circ}C$)

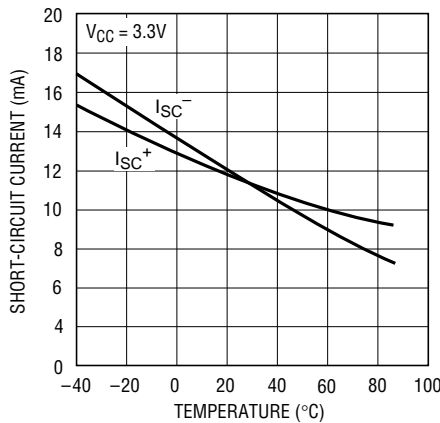

LTC1348 G05

Driver Leakage in SHUTDOWN vs Temperature ($^{\circ}C$)

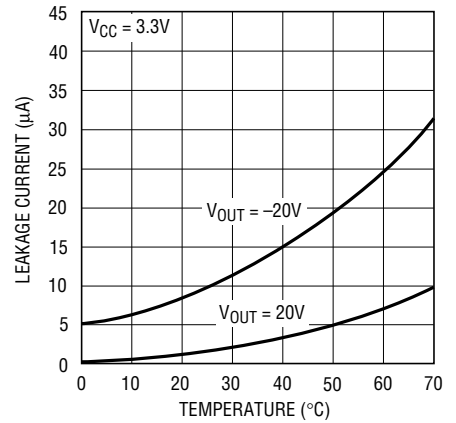

LTC1348 G06

**With $V_{CC} = 3.3V$
All Driver Outputs Loaded with
 $3k\Omega$, 1000pF. 1 Driven at 250kbps**

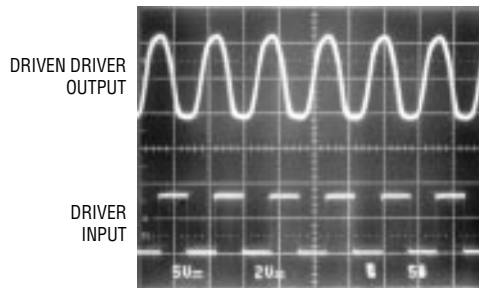

LTC1348 G07

PIN FUNCTIONS

V_{CC}: 3V to 5.5V Input Supply Pin. This pin should be decoupled with a 0.1 μ F ceramic capacitor.

GND: Ground Pin.

RXEN: TTL/CMOS Compatible Enable Pin. Refer to Table 1 for its functional description.

DREN: TTL/CMOS Compatible Enable Pin. Refer to Table 1 for its functional description.

V⁺: Positive Supply Output (RS232 Drivers). This pin requires an external capacitor $C = 0.1\mu\text{F}$ for charge storage. The capacitor may be tied to ground or V_{CC} . With multiple devices, the V^+ and V^- pins may be paralleled into common capacitors. For large numbers of devices, increasing the size of the shared common storage capacitors is recommended to reduce ripple.

V⁻: Negative Supply Output (RS232 Drivers). This pin requires an external capacitor $C = 0.1\mu\text{F}$ for charge storage.

C1⁺, C1⁻, C2⁺, C2⁻, C3⁺, C3⁻: Commutating Capacitor Inputs. These pins require three external capacitors $C = 0.1\mu\text{F}$: one from $C1^+$ to $C1^-$, another from $C2^+$ to $C2^-$ and another from $C3^+$ to $C3^-$. To maintain charge pump

efficiency, the capacitor's effective series resistance should be less than 1 Ω . Ceramic capacitors are recommended.

DR IN: RS232 Driver Input Pins. Inputs are TTL/CMOS compatible. The inputs of unused drivers can be left unconnected since 300k input pull-up resistors to V_{CC} are included on chip. To minimize power consumption, the internal driver pull-up resistors are disconnected from V_{CC} in the Shutdown or Receiver Alive mode.

DR OUT: Driver Outputs at RS232 Voltage Levels. Outputs are in a high impedance state when in the Shutdown, Receiver Alive mode or $V_{CC} = 0\text{V}$. The driver outputs are protected against ESD to $\pm 10\text{kV}$ for human body model discharges.

RX IN: Receiver Inputs. These pins can be forced to $\pm 25\text{V}$ without damage. The receiver inputs are protected against ESD to $\pm 10\text{kV}$ for human body model discharges. Each receiver provides 0.4V of hysteresis for noise immunity. In Receiver Alive mode all receivers have no hysteresis.

RX OUT: Receiver Outputs with TTL/CMOS Voltage Levels. Outputs are in a high impedance state when in the Shutdown or Receiver Disable mode to allow data line sharing.

Table 1. Functional Description

MODE	RX ENABLE	DR ENABLE	DRIVERS	RECEIVERS	I _{CC} TYP
Shutdown	0	0	All Drivers Shutdown. All Driver Outputs Assume High Impedance. All Driver Pull-Up Resistors Disconnect From V_{CC} .	All Receivers Shutdown. All Receiver Outputs Assume High Impedance.	0.2 μA
Receiver Disable	0	1	All Drivers Alive.	All Receiver Outputs in Three-State.	600 μA at 3.3V, 800 μA at 5V
Receiver Alive	1	0	All Drivers Shutdown. All Driver Outputs in Three-State. All Driver Pull-Up Resistors Disconnect From V_{CC} .	All Receivers Alive.	15 μA
Normal	1	1	All Drivers Alive.	All Receivers Alive.	600 μA at 3.3V, 800 μA at 5V

SWITCHING TIME WAVEFORMS

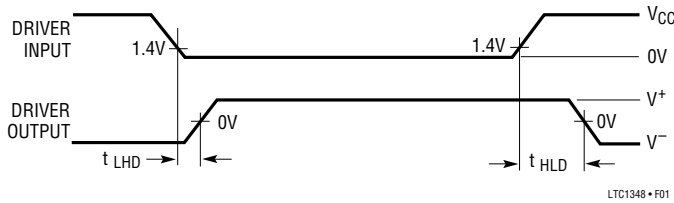

Figure 1. Driver Propagation Delay Timing

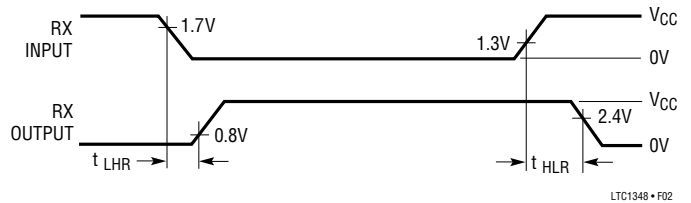

Figure 2. Receiver Propagation Delay Timing

TEST CIRCUITS

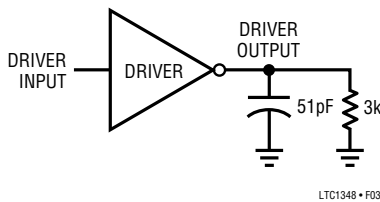

Figure 3. Driver Timing Test Load

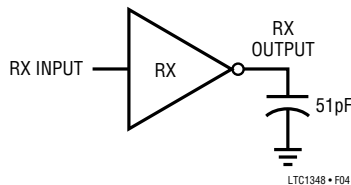
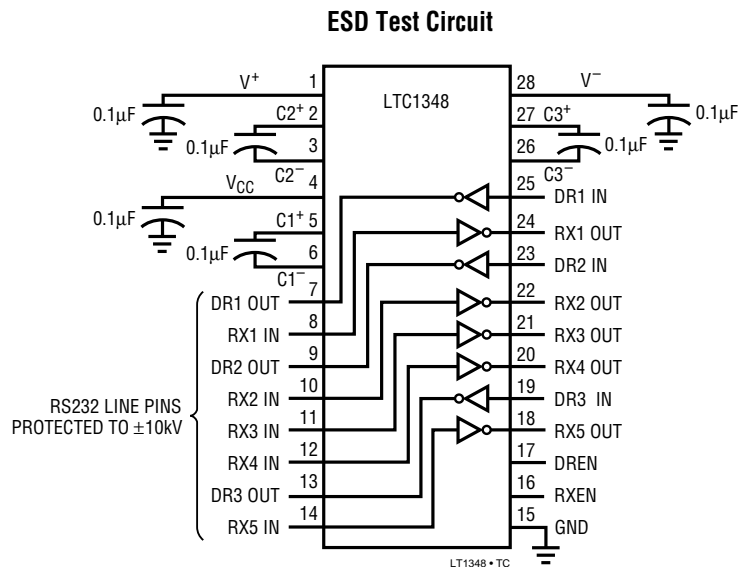

Figure 4. Receiver Timing Test Load



APPLICATIONS INFORMATION

Power Supply

The LTC1348 includes an onboard voltage-tripling charge pump capable of generating $\pm 8V$ from a single 3.3V supply. This allows the LTC1348 drivers to provide guaranteed $\pm 5V$ RS232-compliant voltage levels with a 3.3V supply. With all outputs loaded with 3k Ω , the LTC1348 can typically swing $\pm 5V$ with voltages as low as 2.85V. It will meet the $\pm 3.7V$ EIA562 levels with supply voltages as

low as 2.2V. The charge pump requires three external flying capacitors to operate; 0.1 μF ceramic capacitors are adequate for most applications. For applications requiring extremely high data rates or abnormally heavy output loads, 0.33 μF flying capacitors are recommended. Bypass and output capacitor values should match those of the flying capacitors and all capacitors should be mounted as close to the package as possible.

APPLICATIONS INFORMATION

High Data Rates

The LTC1348 maintains true RS232 $\pm 5V$ minimum driver output even at high data rates. Figure 5 shows a test circuit with 2m wires connecting the two test chips. Both chips are run from 3.3V supplies. Figure 6 shows the typical line waveforms with all three drivers, loaded with 1000pF and 3k Ω , toggling simultaneously at 120kbaud. Figure 7 shows

the same circuit with a single 1000pF/3k Ω loaded driver driven at 250kbaud, and the other two drivers loaded but not toggling. This closely approximates the actual behavior of an RS232 serial port, with only one driver (TX) driven at high speed and the other two drivers (RTS and DTR) driven at a relatively low data rate or at DC. Under the same conditions, the LTC1348 can go as fast as 350kbaud and still meet EIA562 ($\pm 3.7V$) minimum driver output levels.

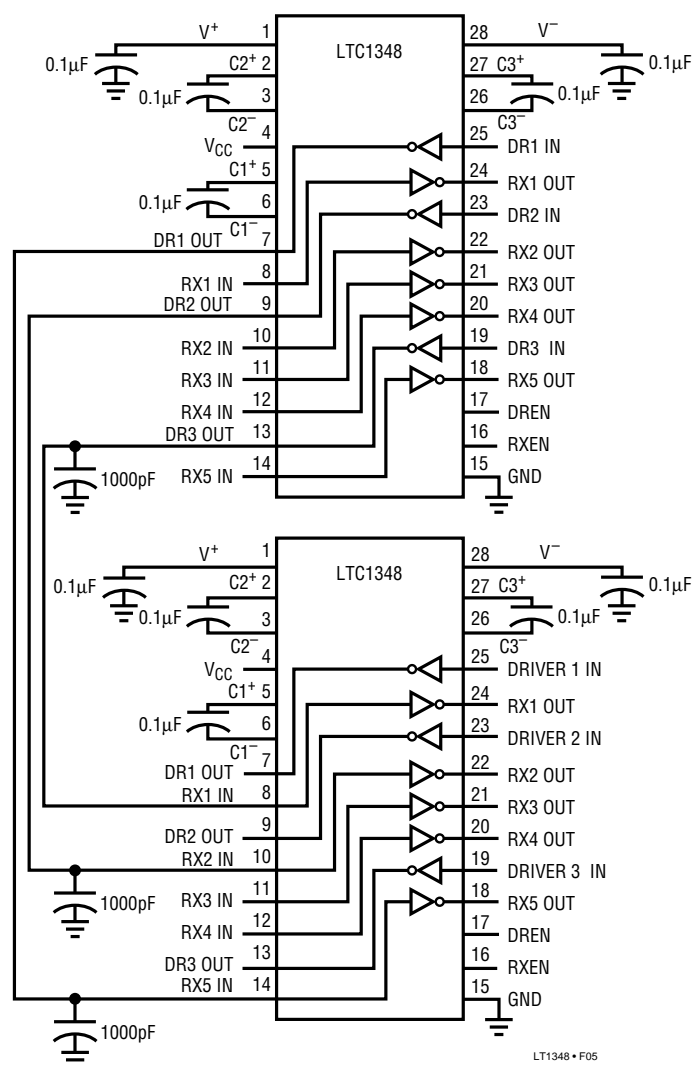

Figure 5. Data Rate Evaluation Circuit

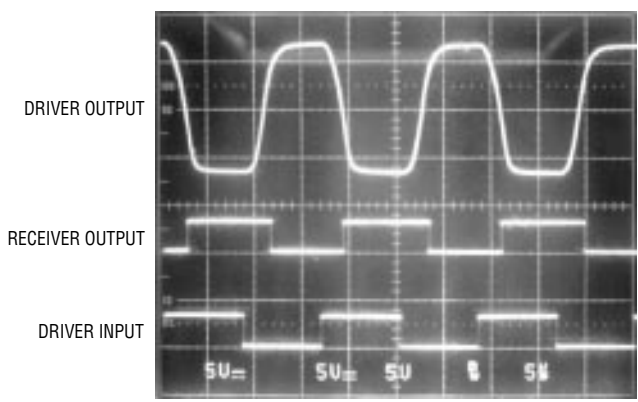

Figure 6. Driver Test Result at 120kbaud

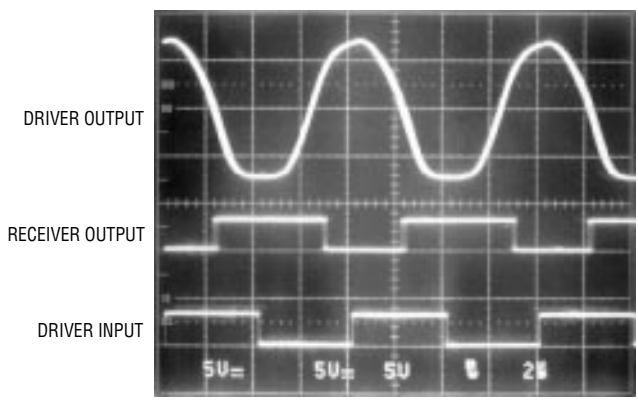
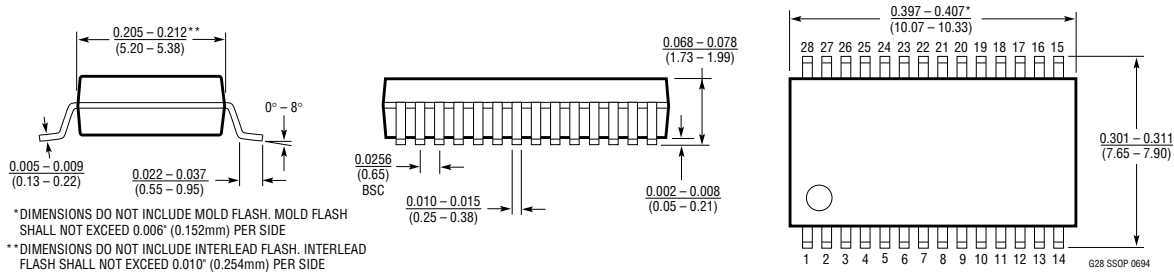

Figure 7. Driver Test Results at 250kbaud

PACKAGE DESCRIPTION Dimensions in inches (millimeters) unless otherwise noted.

G Package 28-Lead Plastic SSOP (0.209) (LTC DWG # 05-08-1640)



SW Package 28-Lead Plastic Small Outline (Wide 0.300) (LTC DWG # 05-08-1620)

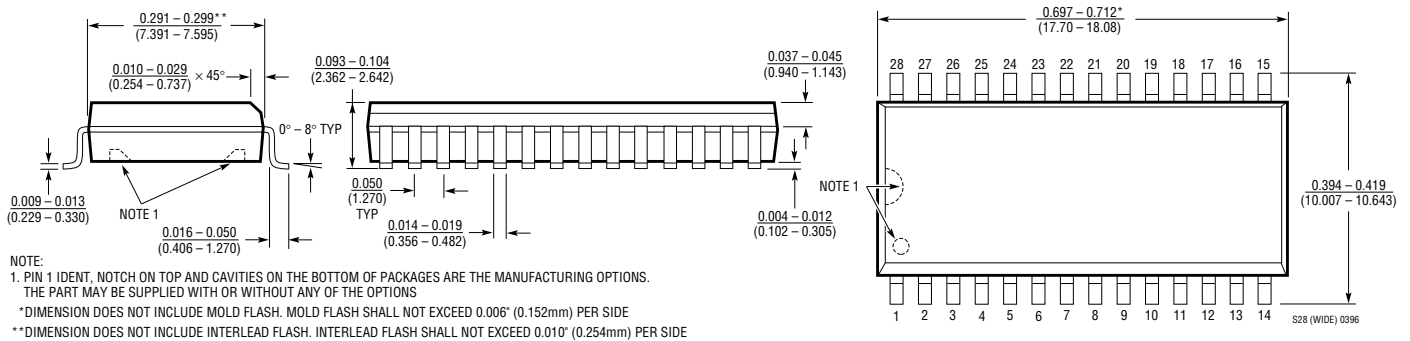

RELATED PARTS

PART NUMBER	DESCRIPTION	COMMENTS
LT1137A	3-DR/5-RX RS232 Transceiver	±15kV IEC-801-2 ESD Protection
LTC1327	3-DR/5-RX RS562 Transceiver	3.3V Operation
LT1330	3-DR/5-RX RS232	3V Logic Interface
LT1331	3-DR/5-RX RS232/RS562 Transceiver	5V RS232 or 3V RS562 Operation
LTC1347	3-DR/5-RX Micropower RS232 Transceiver	5 Receivers Active in Shutdown