

Low Noise, High Frequency, 8th Order Butterworth Lowpass Filter

FEATURES

- 8th Order Filter in a 14-Pin Package
- 140kHz Maximum Corner Frequency
- No External Components
- 50:1 and 100:1 Clock to Cutoff Frequency Ratio
- 80 μ V_{RMS} Total Wideband Noise
- 0.03% THD or Better
- Operates from ± 2.37 V to ± 8 V Power Supplies

APPLICATIONS

- Antialiasing Filters
- Smoothing Filters
- Tracking High Frequency Lowpass Filters

DESCRIPTION

The LTC1064-2 is a monolithic 8th order lowpass Butterworth filter, which provides a maximally flat passband. The attenuation slope is -48 dB/octave and the maximum attenuation is in excess of 80dB. An external TTL or CMOS clock programs the filter's cutoff frequency. The clock to cutoff frequency ratio is 100:1 (pin 10 at negative supply) or 50:1 (pin 10 at V^+). The maximum cutoff frequency is 140kHz. No external components are needed.

The LTC1064-2 features low wideband noise and low harmonic distortion even for input voltages up to 3V_{RMS}. In fact the LTC1064-2 overall performance competes with equivalent multi-op amp RC active realizations. The LTC1064-2 is available in a 14-pin DIP or 16-pin surface mounted SOL package. The LTC1064-2 is fabricated using LTC's enhanced analog CMOS Si-gate process.

The LTC1064-2 is pin compatible with the LTC1064-1.

TYPICAL APPLICATION

**8th Order Clock Sweepable
Lowpass Butterworth Filter**

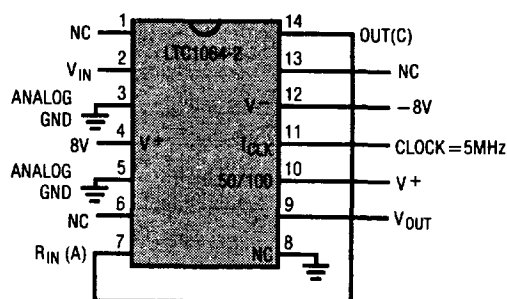

NOTE: THE POWER SUPPLIES SHOULD BE BYPASSED BY A 0.1 μ F CAPACITOR CLOSE TO THE PACKAGE. THE NC PINS 1, 6, 8, AND 13 SHOULD BE PREFERABLY GROUNDED.

Measured Frequency Response

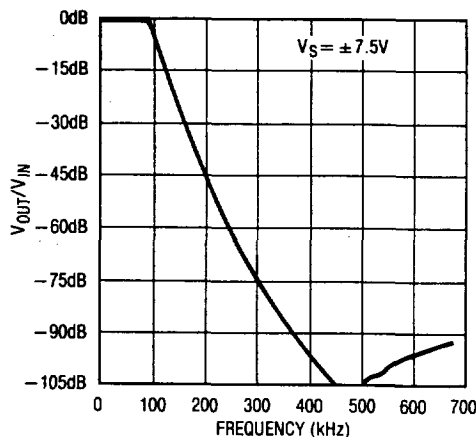

LTC1064-2

ABSOLUTE MAXIMUM RATINGS

Total Supply Voltage (V^+ to V^-)	16.5V
Power Dissipation	400mW
Storage Temperature Range	-65°C to 150°C
Lead Temperature (Soldering, 10 sec.)	300°C

Operating Temperature Range

LTC1064-2M	-55°C to 125°C
LTC1064-2C	-40°C to 85°C

PACKAGE/ORDER INFORMATION

<p>TOP VIEW</p> <p>J PACKAGE 14-LEAD CERAMIC DIP</p> <p>N PACKAGE 14-LEAD PLASTIC DIP</p>	ORDER PART NUMBER	<p>TOP VIEW</p> <p>S PACKAGE 16-LEAD PLASTIC SOL</p>	ORDER PART NUMBER
	LTC1064-2MJ LTC1064-2CJ LTC1064-2CN		LTC1064-2CS

ELECTRICAL CHARACTERISTICS

$V_S = \pm 7.5V$, 100:1, $f_{CLK} = 2MHz$, $R_1 = 10k\Omega$, $T_A = 25^\circ$, TTLclock input level, unless otherwise specified.

PARAMETER	CONDITIONS	MIN	TYP	MAX	UNITS
Passband Gain (Note 1)	Referenced to 0dB, 1Hz to 1kHz	-0.5		0.15	dB
Gain TempCo			0.0002		dB/°C
-3dB Frequency	100:1		20		kHz
	50:1		40		kHz
Gain at -3dB Frequency	Referenced to 0dB, $f_{IN} = 20kHz$		-3	-2.75	dB
Stopband Attenuation	At $1.5f_{-3dB}$, 50:1, $f_{IN} = 60kHz$	-24	-27		dB
Stopband Attenuation	At $2f_{-3dB}$, 100:1, $f_{IN} = 40kHz$	-44	-47		dB
Stopband Attenuation	At $3f_{-3dB}$, 100:1, $f_{IN} = 60kHz$		-74		dB
Stopband Attenuation	At $4f_{-3dB}$, 100:1, $f_{IN} = 80kHz$		-90		dB
Input Frequency Range	100:1	0		$< f_{CLK}/2$	kHz
	50:1	0		$< f_{CLK}$	kHz
Output Voltage Swing and Operating Input Voltage Range	$V_S = \pm 2.37V$	± 1.1			V
	$V_S = \pm 5V$	± 3.1			V
	$V_S = \pm 7.5V$	± 5.0			V
Total Harmonic Distortion	$V_S = \pm 5V$, Input = $1V_{RMS}$ at 1kHz		0.015		%
	$V_S = \pm 7.5V$, Input = $3V_{RMS}$ at 1kHz		0.03		%
Wideband Noise	$V_S = \pm 5V$, Input = GND 1Hz-1.99MHz		80		μV_{RMS}
	$V_S = \pm 7.5V$, Input = GND 1Hz-1.99MHz		90		μV_{RMS}
Output DC Offset (Note 1)	$V_S = \pm 7.5V$		± 30	± 125	mV
Output DC Offset TempCo	$V_S = \pm 5V$		± 90		$\mu V/^\circ C$
Input Impedance		10	20		k Ω
Output Impedance	$f_{OUT} = 10kHz$		2		Ω
Output Short Circuit Current	Source/Sink		3/1		mA
Clock Feedthrough			200		μV_{RMS}
Maximum Clock Frequency	50% Duty Cycle, $V_S = \pm 5V$			5	MHz
	50% Duty Cycle, $T_A = 25^\circ C$, $V_S = \pm 7.5V$			7	MHz
Power Supply Current	$V_S = \pm 2.37V$, $f_{CLK} = 1MHz$		11	22	mA
	$V_S = \pm 5V$, $f_{CLK} = 1MHz$		14	23	mA
				26	mA
	$V_S = \pm 7.5V$, $f_{CLK} = 1MHz$		17	28	mA
				32	mA
Power Supply Voltage Range		± 2.37		± 8	V

The ● denotes the specifications which apply over the full operating temperature range.

Note 1: For tighter specifications contact LTC Marketing.

TYPICAL PERFORMANCE CHARACTERISTICS

Graph 1. Amplitude Response

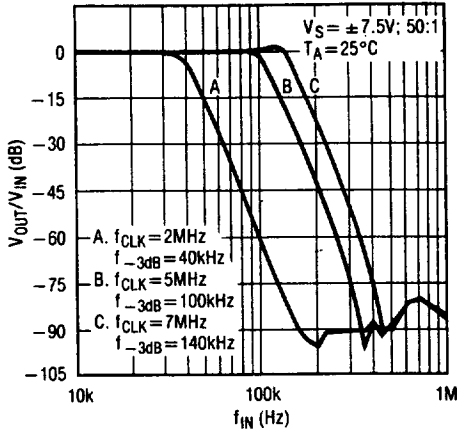

Graph 2. Phase Response

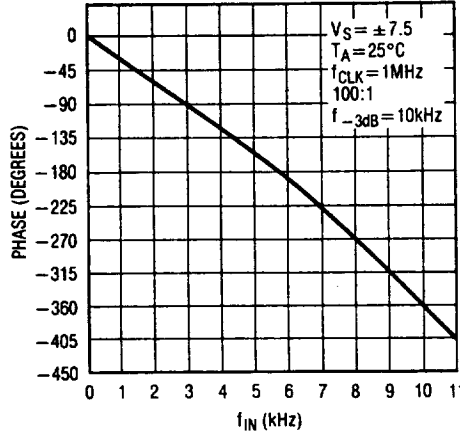

Graph 3. Group Delay vs Frequency

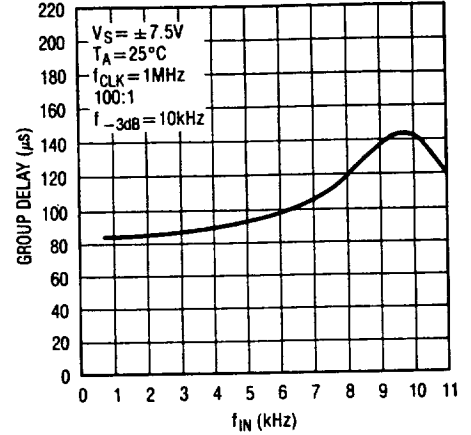

Graph 4. Phase vs f_{-3dB} Frequency

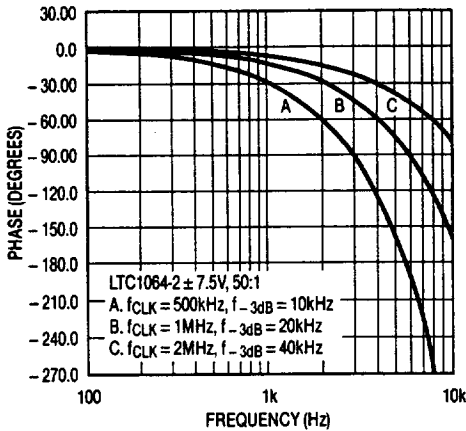

Graph 5. Phase Matching

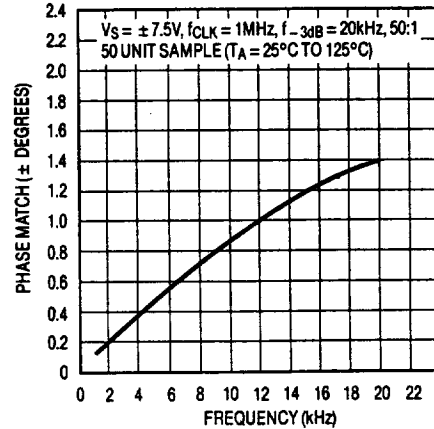

Graph 6. Noise Spectral Density

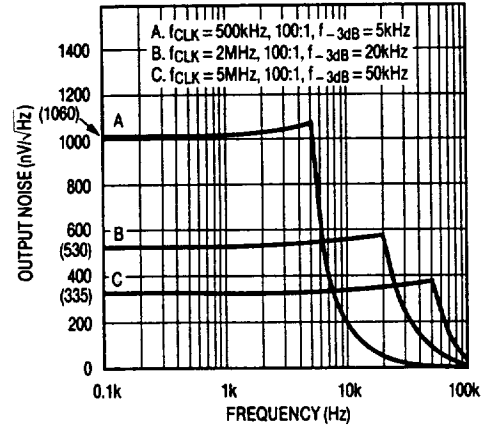

Graph 7. Harmonic Distortion vs Frequency

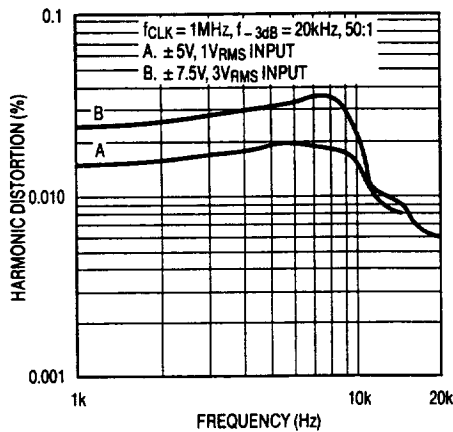

Graph 8. Harmonic Distortion vs Amplitude

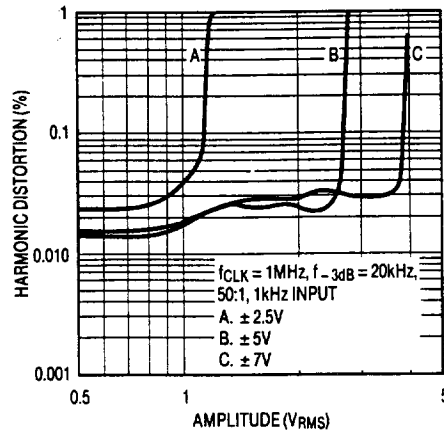

Graph 9. Power Supply vs Current

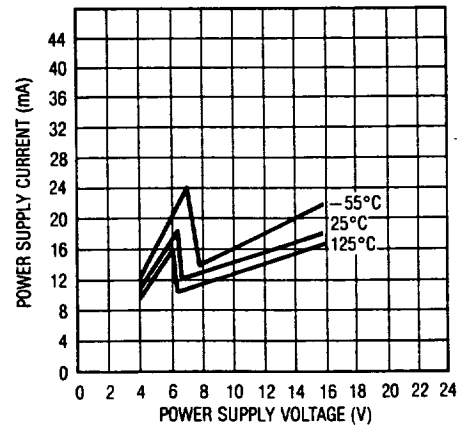

TYPICAL PERFORMANCE CHARACTERISTICS

Graph 10. Amplitude Response with Pin 10 at Ground

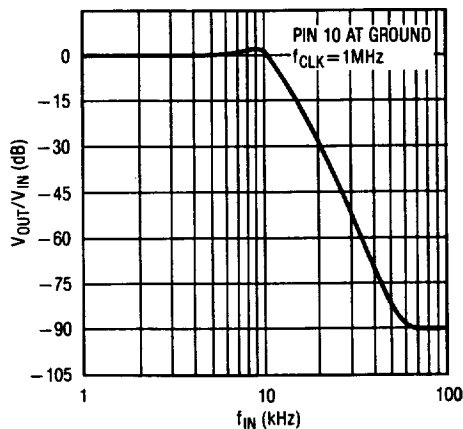

Table 1. Gain/Delay, $f_{-3dB} = 1\text{kHz}$, LTC1064-2 Typical Response $V_S = \pm 5\text{V}$, $T_A = 25^\circ\text{C}$ $f_{CLK} = 50\text{kHz}$, Ratio = Pin 10 at V^+ (fltr 50:1)

FREQUENCY	GAIN	DELAY
0.200kHz	-0.247dB	0.857ms
0.300kHz	-0.270dB	0.872ms
0.400kHz	-0.290dB	0.893ms
0.500kHz	-0.300dB	0.929ms
0.600kHz	-0.320dB	0.983ms
0.700kHz	-0.370dB	1.071ms
0.800kHz	-0.520dB	1.210ms
0.900kHz	-1.200dB	1.364ms
1.000kHz	-3.380dB	1.381ms
1.100kHz	-7.530dB	1.192ms
1.200kHz	-12.670dB	0.935ms

Table 2. Gain, $f_{-3dB} = 1\text{kHz}$, LTC1064-2 Typical Response $V_S = \pm 5\text{V}$, $T_A = 25^\circ\text{C}$ $f_{CLK} = 50\text{kHz}$, Ratio = Pin 10 at V^+ (fltr 50:1)

FREQUENCY	GAIN
0.500kHz	-0.298dB
1.000kHz	-3.380dB
1.500kHz	-27.500dB
2.000kHz	-47.200dB
2.500kHz	-63.300dB
3.000kHz	-75.190dB
3.500kHz	-86.100dB
4.000kHz	-95.310dB
4.500kHz	-104.240dB
5.000kHz	-109.650dB
5.500kHz	-121.930dB
6.000kHz	-123.920dB
6.500kHz	-114.150dB
7.000kHz	-116.990dB
7.500kHz	-120.070dB
8.000kHz	-113.470dB
8.500kHz	-130.090dB
9.000kHz	-114.770dB
9.500kHz	-117.760dB

Table 3. Gain/Delay, $f_{-3dB} = 1\text{kHz}$, LTC1064-2 Typical Response $V_S = \pm 5\text{V}$, $T_A = 25^\circ\text{C}$ $f_{CLK} = 100\text{kHz}$, Ratio = Pin 10 at V^- (fltr 100:1)

FREQUENCY	GAIN	DELAY
0.200kHz	-0.213dB	0.821ms
0.300kHz	-0.240dB	0.837ms
0.400kHz	-0.260dB	0.858ms
0.500kHz	-0.280dB	0.893ms
0.600kHz	-0.310dB	0.947ms
0.700kHz	-0.370dB	1.034ms
0.800kHz	-0.530dB	1.172ms
0.900kHz	-1.200dB	1.325ms
1.000kHz	-3.370dB	1.346ms
1.100kHz	-7.500dB	1.158ms
1.200kHz	-12.640dB	0.899ms

TYPICAL PERFORMANCE CHARACTERISTICS

Table 4. Gain, $f_{-3dB} = 1\text{kHz}$,
LTC1064-2 Typical Response $V_S = \pm 5\text{V}$, $T_A = 25^\circ\text{C}$
 $f_{CLK} = 100\text{kHz}$, Ratio = Pin 10 at V^- (fltr 100:1)

FREQUENCY	GAIN
0.500kHz	-0.279dB
1.000kHz	-3.370dB
1.500kHz	-27.500dB
2.000kHz	-47.200dB
2.500kHz	-62.300dB
3.000kHz	-75.130dB
3.500kHz	-86.090dB
4.000kHz	-95.210dB
4.500kHz	-103.030dB
5.000kHz	-108.690dB
5.500kHz	-114.830dB
6.000kHz	-120.540dB
6.500kHz	-114.750dB
7.000kHz	-116.430dB
7.500kHz	-120.790dB
8.000kHz	-121.290dB
8.500kHz	-119.970dB
9.000kHz	-120.020dB
9.500kHz	-125.170dB

Table 5. Gain, $f_{-3dB} = 20\text{kHz}$,
LTC1064-2 Typical Response $V_S = \pm 7.5\text{V}$, $T_A = 25^\circ\text{C}$
 $f_{CLK} = 1\text{MHz}$, Ratio = Pin 10 at V^+ (fltr 50:1)

FREQUENCY	GAIN
10.000kHz	-0.308dB
20.000kHz	-3.350dB
30.000kHz	-27.400dB
40.000kHz	-47.100dB
50.000kHz	-62.300dB
60.000kHz	-74.890dB
70.000kHz	-85.430dB
80.000kHz	-95.070dB
90.000kHz	-103.150dB
100.000kHz	-108.700dB
110.000kHz	-107.520dB
120.000kHz	-108.030dB
130.000kHz	-104.990dB
140.000kHz	-106.090dB
150.000kHz	-105.320dB

Table 6. Gain, $f_{-3dB} = 140\text{kHz}$,
LTC1064-2 Typical Response $V_S = \pm 7.5\text{V}$, $T_A = 25^\circ\text{C}$
 $f_{CLK} = 7\text{MHz}$, Ratio = Pin 10 at V^+ (fltr 50:1)

FREQUENCY	GAIN
50.000kHz	-0.238dB
60.000kHz	-0.140dB
70.000kHz	0.050dB
80.000kHz	0.350dB
90.000kHz	0.810dB
100.000kHz	1.450dB
110.000kHz	2.110dB
120.000kHz	1.830dB
130.000kHz	-0.700dB
140.000kHz	-4.840dB
150.000kHz	-9.350dB
160.000kHz	-13.690dB
170.000kHz	-17.760dB
180.000kHz	-21.600dB
190.000kHz	-25.200dB
200.000kHz	-28.500dB
210.000kHz	-31.800dB
220.000kHz	-34.800dB
230.000kHz	-37.700dB
240.000kHz	-40.500dB
250.000kHz	-43.200dB
260.000kHz	-45.700dB
270.000kHz	-48.200dB
280.000kHz	-50.500dB
290.000kHz	-52.700dB
300.000kHz	-54.900dB

TYPICAL PERFORMANCE CHARACTERISTICS

Table 7. Gain for Non-Butterworth Response (Pin 10 to GND)
 LTC1064-2 Typical Response $V_S = \pm 5V, T_A = 25^\circ C$
 $f_{CLK} = 100kHz$

FREQUENCY	GAIN
0.500kHz	-0.012dB
1.000kHz	1.240dB
1.500kHz	-14.690dB
2.000kHz	-28.600dB
2.500kHz	-41.100dB
3.000kHz	-52.500dB
3.500kHz	-62.800dB
4.000kHz	-71.500dB
4.500kHz	-79.370dB
5.000kHz	-86.730dB
5.500kHz	-93.340dB
6.000kHz	-99.350dB
6.500kHz	-105.270dB
7.000kHz	-113.270dB
7.500kHz	-114.600dB
8.000kHz	-114.010dB
8.500kHz	-122.810dB
9.000kHz	-122.980dB
9.500kHz	-119.450dB

PIN DESCRIPTION

Power Supply Pins (4, 12)

The V^+ (pin 4) and V^- (pin 12) should be bypassed with a $0.1\mu F$ capacitor to an adequate analog ground. Low noise, non-switching power supplies are recommended. **To avoid latch up when the power supplies exhibit high turn-on transients, a 1N5817 schottky diode should be added from the V^+ and V^- pins to ground, Figures 1, 2 and 3.**

Clock Pin (11)

For $\pm 5V$ supplies the logic threshold level is 1.4V. For $\pm 8V$ and $0V$ to $5V$ supplies the logic threshold levels are 2.2V and 3V respectively. The logic threshold levels vary $\pm 100mV$ over the full military temperature range. The

recommended duty cycle of the input clock is 50% although for clock frequencies below 500kHz the clock "on" time can be as low as 200ns. The maximum clock frequency for $\pm 5V$ supplies is 4MHz. For $\pm 7V$ supplies and above, the maximum clock frequency is 7MHz. Do not allow the clock levels to exceed the power supplies. For single supply operation $\geq 6V$ use level shifting at pin 11 with T^2L levels, see Figure 4.

Analog Ground Pins (3, 5)

For dual supply operation these pins should be connected to a ground plane. For single supply operation both pins should be tied to one half supply, Figure 3.

PIN DESCRIPTION

Connection Pins (7, 14)

A very short connection between pins 14 and 7 is recommended. This connection should be preferably done under the IC package. In a breadboard, use a one inch, or less, shielded coaxial cable; the shield should be grounded. In a PC board, use a one inch trace or less; surround the trace by a ground plane.

Input, Output Pins (2, 9)

The input pin 2 is connected to an 18kΩ resistor tied to the inverting input of an op amp. Pin 2 is protected against static discharge. The device's output, pin 9, is the output of an op amp which can typically source/sink 3/1mA. Although the internal op amps are unity gain stable, driving long coax cables is not recommended.

When testing the device for noise and distortion, the output, pin 9, should be buffered, Figure 1. The op amp power supply wire (or trace) should be connected directly to the

power source. To eliminate switching transients from filter output, buffer filter output with a third order lowpass, see Figure 5.

NC Pins (1, 6, 8, 13)

The "no connection" pins should be preferably grounded. These pins are not internally connected.

Ratio Pin (10)

The DC level at this pin determines the ratio of clock frequency to the -3dB frequency of the filter. The ratio is 50:1 when pin 10 is at V+ and 100:1 when pin 10 is at V-. This pin should be bypassed with a 0.1μF capacitor to analog ground when it's connected to V- or V+, Figure 1. See Tables 1 through 7 for typical gain and delay responses for the two ratios.

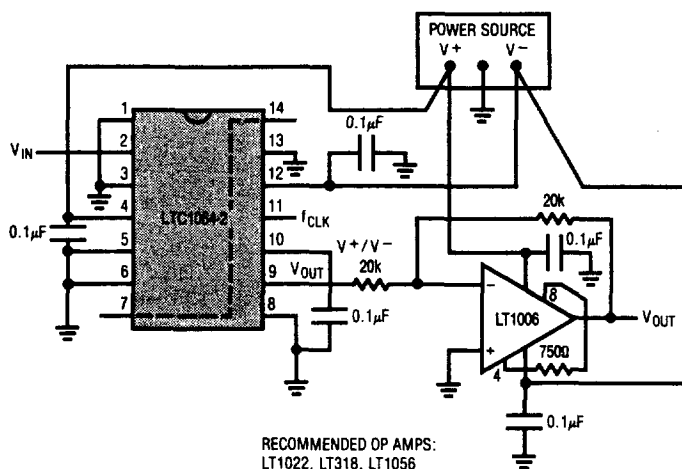

Figure 1. Buffering the Filter Output. The Buffer Op Amp Should Not Share the LTC1064-2 Power Lines.

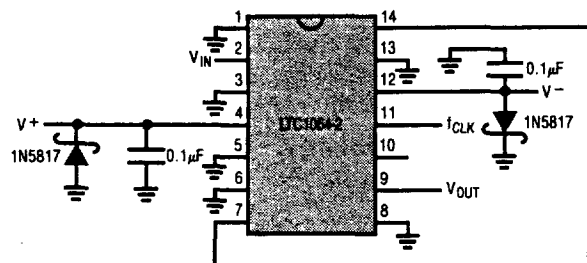

Figure 2. Using Schottky Diodes to Protect the IC from Transient Supply Reversal.

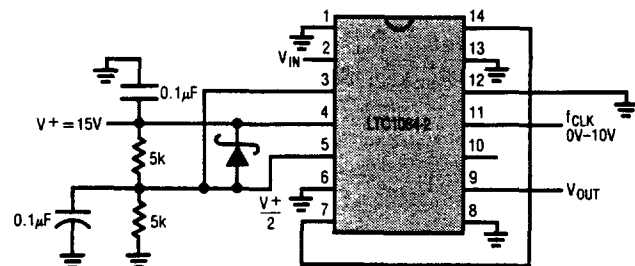

Figure 3. Single Supply Operation. If Fast Power Up or Down Transients are Expected, Use a 1N5817 Schottky Diode Between Pins 4 and 5. For V+ = 5V, Derive the Mid-Supply Voltage with a 7.5k Resistor and an LT1004 2.5V Reference.

PIN DESCRIPTION

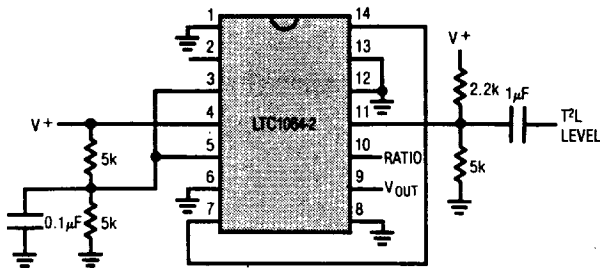

Figure 4. Level Shifting the Input T²L Clock for Single Supply Operation $\geq 6V$.

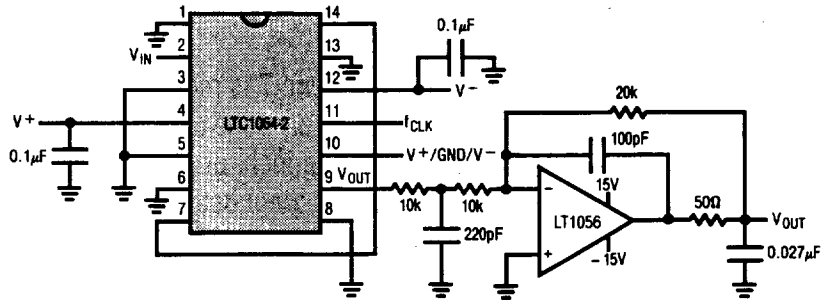

Figure 5. Adding an Output Buffer-Filter to Eliminate Any Clock Feedthrough. Passband $\pm 0.1dB$ to 50kHz, $-3dB$ at 94kHz.