

FEATURES

- **Ultralow Quiescent Current: 3 μ A**
- **Input Voltage Range: 2.0V to 45V**
- **Output Current: 20mA**
- **Dropout Voltage: 300mV**
- **Adjustable Output (V_{ADJ} = V_{OUT(MIN)} = 600mV)**
- **Output Tolerance: \pm 2% Over Load, Line and Temperature**
- **Stable with Low ESR, Ceramic Output Capacitors (2.2 μ F minimum)**
- **Shutdown Current: <1 μ A**
- **Current Limit Protection**
- **Reverse-Battery Protection**
- **Thermal Limit Protection**
- **TSOT-23 and 2mm \times 2mm DFN Packages**

APPLICATIONS

- Automotive
- Low Current Battery-Powered Systems
- Keep-Alive Power Supplies
- Remote Monitoring
- Utility Meters
- Low Power Industrial Applications

DESCRIPTION

The LT[®]3008 is a micropower, low dropout voltage (LDO) linear regulator. The device supplies 20mA output current with a dropout voltage of 300mV. No-load quiescent current is 3 μ A. Ground pin current remains at less than 5% of output current as load increases. In shutdown, quiescent current is less than 1 μ A.

The LT3008 regulator optimizes stability and transient response with low ESR ceramic capacitors, requiring a minimum of only 2.2 μ F. The LT3008 does not require the addition of ESR as is common with other regulators. Internal protection circuitry includes current limiting, thermal limiting, reverse-battery protection and reverse-current protection.

The LT3008 is ideal for applications that require moderate output drive capability coupled with ultralow standby power consumption. The device is available as an adjustable device with an output voltage range down to the 600mV reference. The LT3008 is available in the 6-lead DFN and 8-lead TSOT-23 packages.

LT, LT, LTC and LTM are registered trademarks of Linear Technology Corporation. All other trademarks are the property of their respective owners.

TYPICAL APPLICATION

3.3V, 20mA Supply with Shutdown

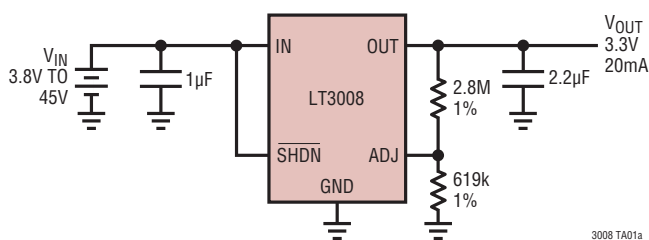

Dropout Voltage/Quiescent Current

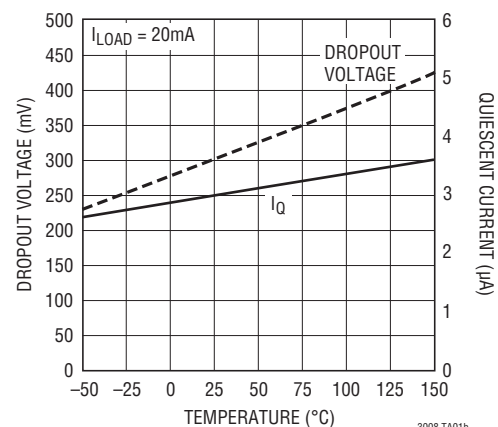

LT3008

ABSOLUTE MAXIMUM RATINGS (Note 1)

IN Pin Voltage	±50V	Operating Junction Temperature Range (Notes 2, 3)	
OUT Pin Voltage	±50V	LT3008E	–40°C to 125°C
Input-to-Output Differential Voltage	±50V	LT3008I	–40°C to 125°C
ADJ Pin Voltage	±50V	Storage Temperature Range	–65°C to 150°C
SHDN Pin Voltage (Note 8)	±50V	Lead Temperature: Soldering, 10 sec	
Output Short-Circuit Duration	Indefinite	TS8 Package Only	300°C

PIN CONFIGURATION

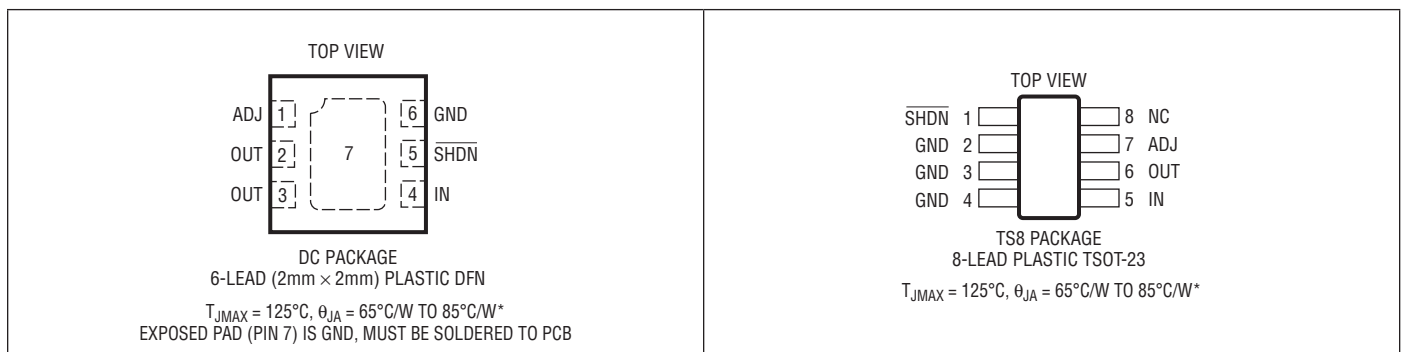

* See Applications Information Section.

ORDER INFORMATION

LEAD FREE FINISH	TAPE AND REEL	PART MARKING*	PACKAGE DESCRIPTION	TEMPERATURE RANGE
LT3008EDC#PBF	LT3008EDC#TRPBF	LDPS	6-Lead (2mm × 2mm) Plastic DFN	–40°C to 125°C
LT3008IDC#PBF	LT3008IDC#TRPBF	LDPS	6-Lead (2mm × 2mm) Plastic DFN	–40°C to 125°C
LT3008ETS8#PBF	LT3008ETS8#TRPBF	LTDSX	8-Lead Plastic TSOT-23	–40°C to 125°C
LT3008ITS8#PBF	LT3008ITS8#TRPBF	LTDSX	8-Lead Plastic TSOT-23	–40°C to 125°C
LEAD BASED FINISH	TAPE AND REEL	PART MARKING*	PACKAGE DESCRIPTION	TEMPERATURE RANGE
LT3008EDC	LT3008EDC#TR	LDPS	6-Lead (2mm × 2mm) Plastic DFN	–40°C to 125°C
LT3008IDC	LT3008IDC#TR	LDPS	6-Lead (2mm × 2mm) Plastic DFN	–40°C to 125°C
LT3008ETS8	LT3008ETS8#TR	LTDSX	8-Lead Plastic TSOT-23	–40°C to 125°C
LT3008ITS8	LT3008ITS8#TR	LTDSX	8-Lead Plastic TSOT-23	–40°C to 125°C

Consult LTC Marketing for parts specified with wider operating temperature ranges. *The temperature grade is identified by a label on the shipping container.

For more information on lead free part marking, go to: <http://www.linear.com/leadfree/>

For more information on tape and reel specifications, go to: <http://www.linear.com/tapeandreeel/>

ELECTRICAL CHARACTERISTICS The ● denotes the specifications which apply over the full operating temperature range, otherwise specifications are at $T_J = 25^\circ\text{C}$. (Note 2)

PARAMETER	CONDITIONS		MIN	TYP	MAX	UNITS
Operating Voltage		●	2		45	V
ADJ Pin Voltage (Notes 3, 4)	$V_{IN} = 2\text{V}, I_{LOAD} = 100\mu\text{A}$ $2\text{V} < V_{IN} < 45\text{V}, 1\mu\text{A} < I_{LOAD} < 20\text{mA}$	●	594	600	606	mV
Line Regulation (Note 3)	$\Delta V_{IN} = 2\text{V to } 45\text{V}, I_{LOAD} = 1\text{mA}$	●		0.6	3	mV
Load Regulation (Note 3)	$V_{IN} = 2\text{V}, I_{LOAD} = 1\mu\text{A to } 10\text{mA}$ $V_{IN} = 2\text{V}, I_{LOAD} = 1\mu\text{A to } 20\text{mA}$	●		0.4	2	mV
Dropout Voltage $V_{IN} = V_{OUT(NOMINAL)}$ (Notes 5, 6)	$I_{LOAD} = 100\mu\text{A}$ $I_{LOAD} = 100\mu\text{A}$	●		115	180	mV
	$I_{LOAD} = 1\text{mA}$ $I_{LOAD} = 1\text{mA}$	●		170	250	mV
	$I_{LOAD} = 10\text{mA}$ $I_{LOAD} = 10\text{mA}$	●		270	340	mV
	$I_{LOAD} = 20\text{mA}$ $I_{LOAD} = 20\text{mA}$	●		300	365	mV
Quiescent Current (Notes 6, 7)	$I_{LOAD} = 0\mu\text{A}$ $I_{LOAD} = 0\mu\text{A}$	●		3	6	μA
	$I_{LOAD} = 0\mu\text{A}$ $I_{LOAD} = 100\mu\text{A}$ $I_{LOAD} = 1\text{mA}$ $I_{LOAD} = 10\text{mA}$ $I_{LOAD} = 20\text{mA}$	●		3	6	μA
GND Pin Current $V_{IN} = V_{OUT(NOMINAL)} + 0.5\text{V}$ (Notes 6, 7)	$I_{LOAD} = 0\mu\text{A}$ $I_{LOAD} = 100\mu\text{A}$ $I_{LOAD} = 1\text{mA}$ $I_{LOAD} = 10\text{mA}$ $I_{LOAD} = 20\text{mA}$	●		6	12	μA
Output Voltage Noise (Note 9)	$C_{OUT} = 2.2\mu\text{F}, I_{LOAD} = 20\text{mA}, \text{BW} = 10\text{Hz to } 100\text{kHz}$			92		μV_{RMS}
ADJ Pin Bias Current		●	-10	0.4	10	nA
Shutdown Threshold	$V_{OUT} = \text{Off to On}$	●		0.67	1.5	V
	$V_{OUT} = \text{On to Off}$	●	0.25	0.61		V
SHDN Pin Current	$V_{SHDN} = 0\text{V}, V_{IN} = 45\text{V}$	●			± 1	μA
	$V_{SHDN} = 45\text{V}, V_{IN} = 45\text{V}$	●		0.65	2	μA
Quiescent Current in Shutdown	$V_{IN} = 6\text{V}, V_{SHDN} = 0\text{V}$	●			<1	μA
Ripple Rejection (Note 3)	$V_{IN} - V_{OUT} = 1.5\text{V}, V_{\text{RIPPLE}} = 0.5\text{V}_{\text{P-P}},$ $f_{\text{RIPPLE}} = 120\text{Hz}, I_{LOAD} = 20\text{mA}$		58	70		dB
Current Limit	$V_{IN} = 45\text{V}, V_{OUT} = 0$			75		mA
	$V_{IN} = V_{OUT(NOMINAL)} + 1\text{V}, \Delta V_{OUT} = -5\%$	●	22			mA
Input Reverse Leakage Current	$V_{IN} = -45\text{V}, V_{OUT} = 0$	●		1	30	μA
Reverse Output Current	$V_{OUT} = 1.2\text{V}, V_{IN} = 0$			0.6	10	μA

Note 1: Stresses beyond those listed under Absolute Maximum Ratings may cause permanent damage to the device. Exposure to any Absolute Maximum Rating condition for extended periods may affect device reliability and lifetime.

Note 2: The LT3008 is tested and specified under pulse load conditions such that $T_J \cong T_A$. The LT3008E is 100% tested at $T_A = 25^\circ\text{C}$. Performance at -40°C and 125°C is assured by design, characterization and correlation with statistical process controls. The LT3008I is guaranteed over the full -40°C to 125°C operating junction temperature range.

Note 3: The LT3008 adjustable version is tested and specified for these conditions with the ADJ pin connected to the OUT pin.

Note 4: Operating conditions are limited by maximum junction temperature. The regulated output voltage specification will not apply for all possible combinations of input voltage and output current. When operating at the maximum input voltage, the output current range must be limited. When operating at the maximum output current, the input voltage must be limited.

Note 5: Dropout voltage is the minimum input to output voltage differential needed to maintain regulation at a specified output current. In dropout, the output voltage equals $(V_{IN} - V_{\text{DROPOUT}})$.

ELECTRICAL CHARACTERISTICS

The ● denotes the specifications which apply over the full operating temperature range, otherwise specifications are at $T_J = 25^\circ\text{C}$. (Note 2)

Note 6: To satisfy minimum input voltage requirements, the LT3008 adjustable version is tested and specified for these conditions with an external resistor divider (61.9k bottom, 280k top) which sets V_{OUT} to 3.3V. The external resistor divider adds 9.69 μA of DC load on the output. This external current is not factored into GND pin current.

Note 7: GND pin current is tested with $V_{IN} = V_{OUT(NOMINAL)} + 0.5\text{V}$ and a current source load. GND pin current will increase in dropout. See the GND Pin Current curves in the Typical Performance Characteristics section.

Note 8: The $\overline{\text{SHDN}}$ pin can be driven below GND only when tied to the IN pin directly or through a pull-up resistor. If the $\overline{\text{SHDN}}$ pin is driven below GND by more than -0.3V while IN is powered, the output will turn on.

Note 9: Output noise is listed for the adjustable version with the ADJ pin connected to the OUT pin. See the RMS Output Noise vs Load Current curve in the Typical Performance Characteristics Section.

TYPICAL PERFORMANCE CHARACTERISTICS

$T_J = 25^\circ\text{C}$, unless otherwise noted.

Dropout Voltage

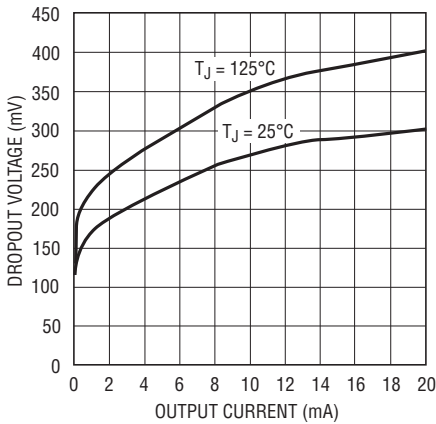

3008 G01

Dropout Voltage

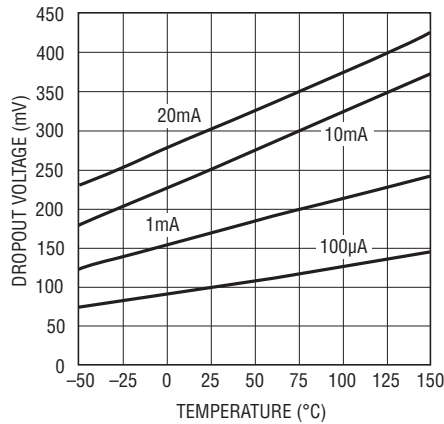

3008 G02

Minimum Input Voltage

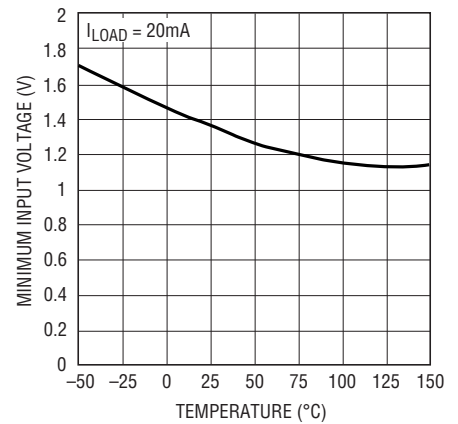

3008 G03

ADJ Pin Voltage

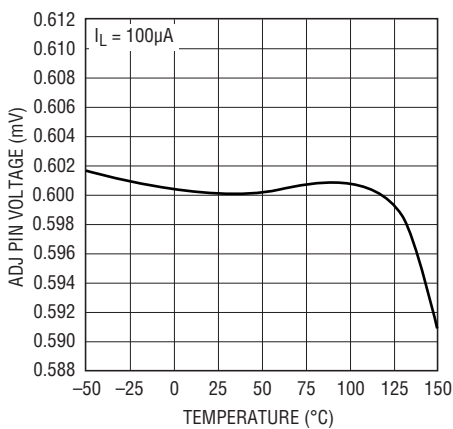

3008 G04

ADJ Pin Bias Current

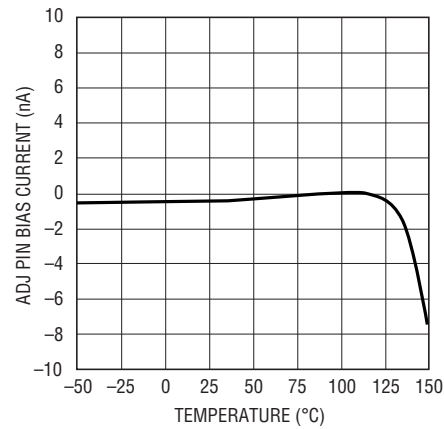

3008 G05

Quiescent Current

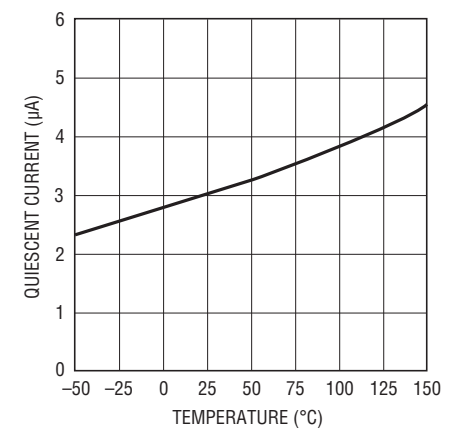

3008 G06

TYPICAL PERFORMANCE CHARACTERISTICS $T_J = 25^\circ\text{C}$, unless otherwise noted.

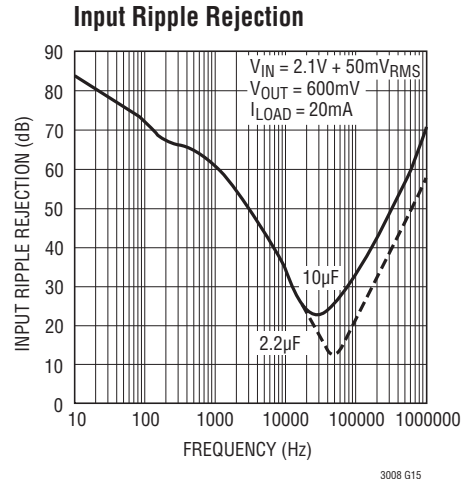
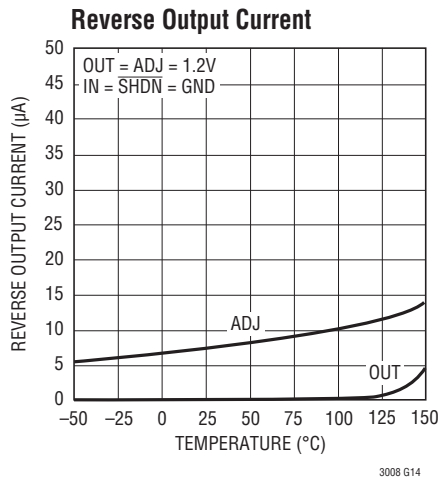
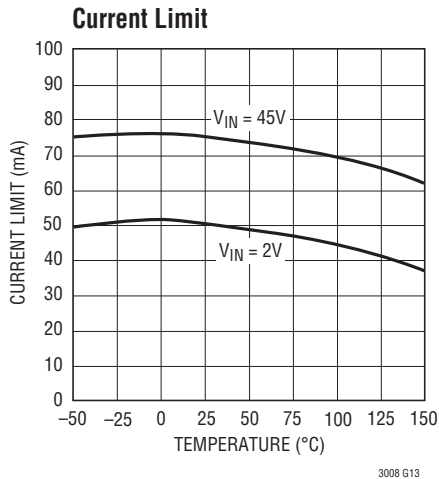
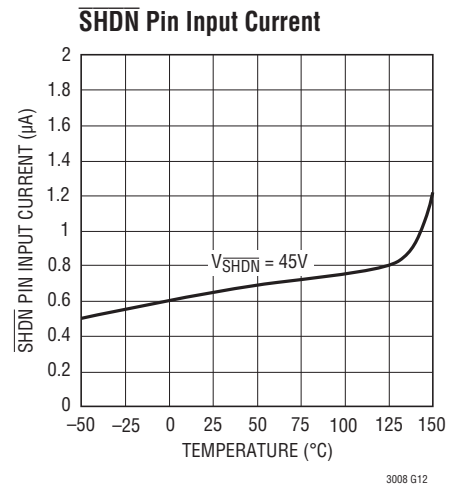
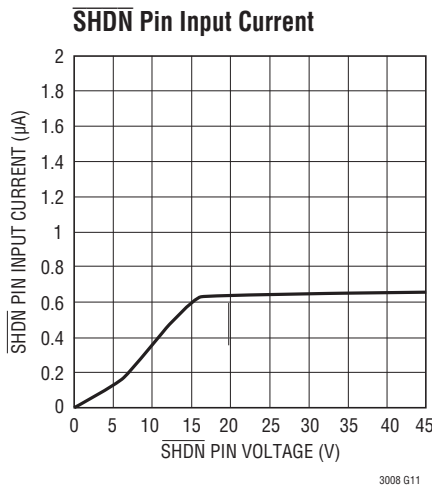
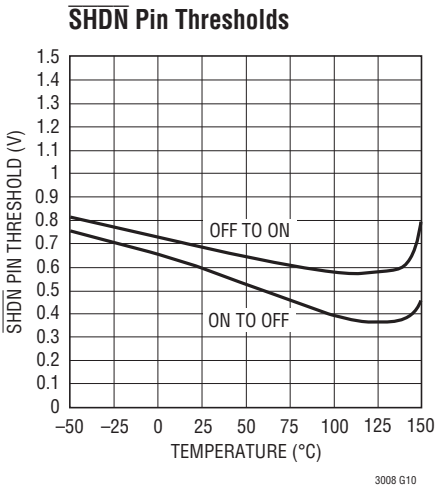
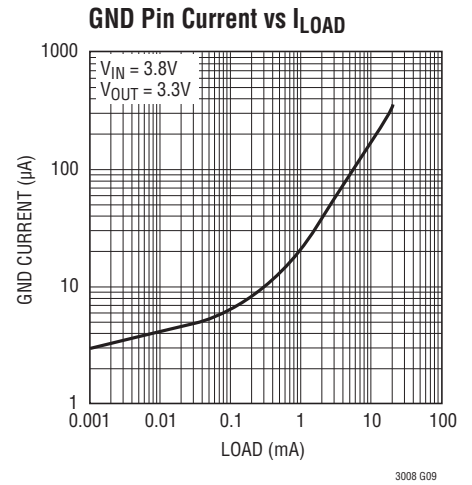
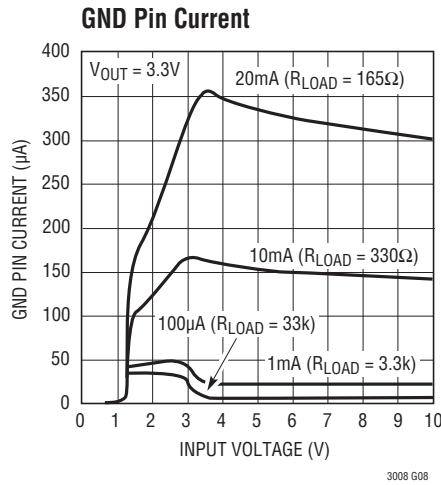
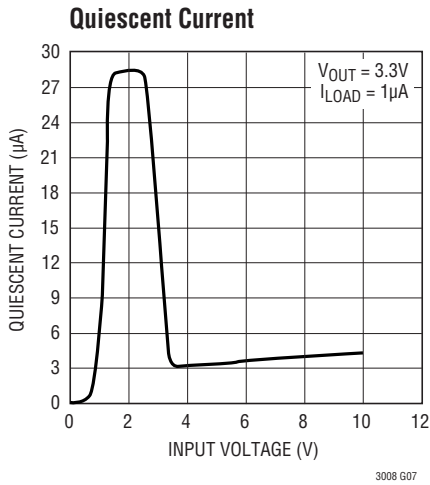

TYPICAL PERFORMANCE CHARACTERISTICS $T_J = 25^\circ\text{C}$, unless otherwise noted.

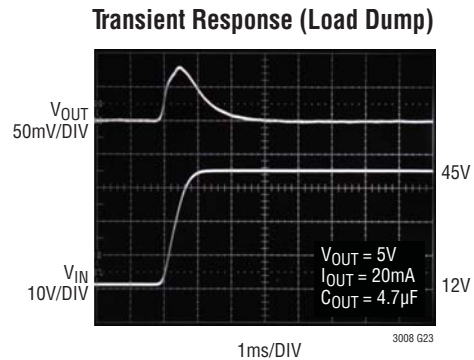
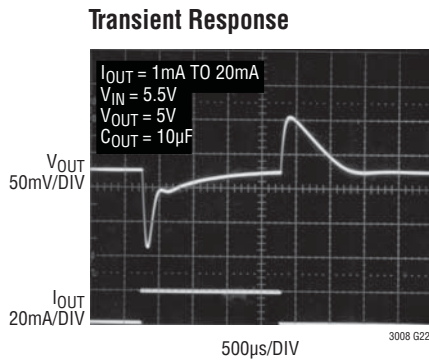
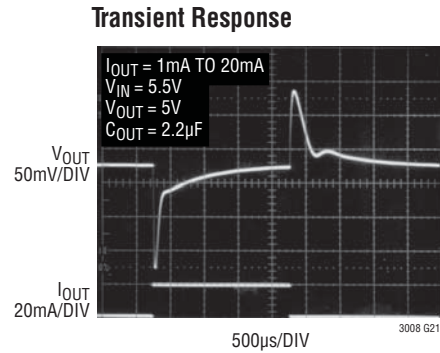
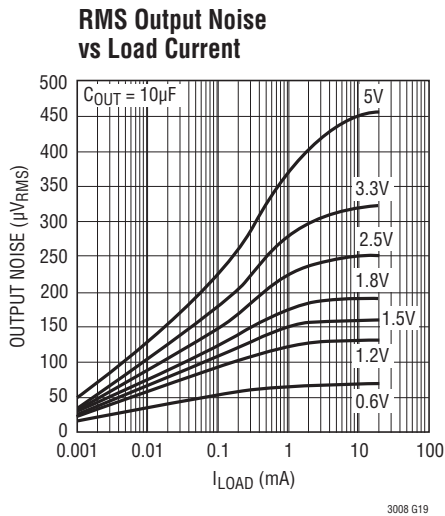
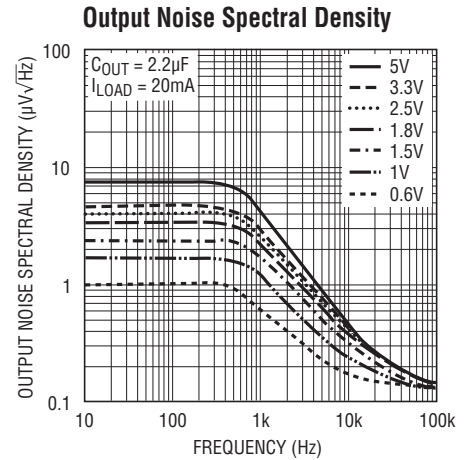
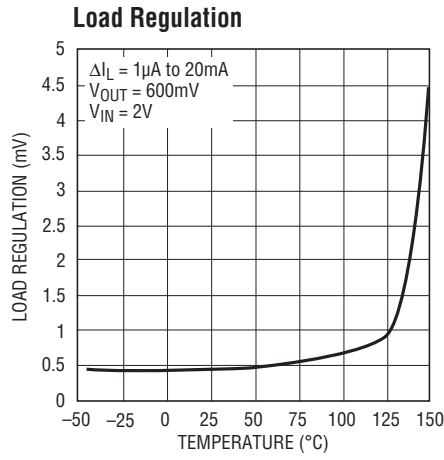
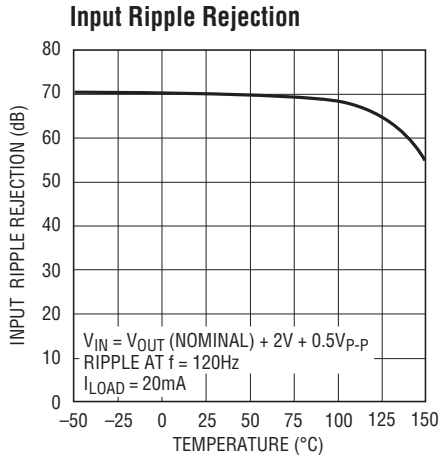

PIN FUNCTIONS (TSOT-23/DFN)

$\overline{\text{SHDN}}$ (Pin 1/Pin 5): Shutdown. Pulling the $\overline{\text{SHDN}}$ pin low puts the LT3008 into a low power state and turns the output off. If unused, tie the $\overline{\text{SHDN}}$ pin to V_{IN} . The LT3008 does not function if the $\overline{\text{SHDN}}$ pin is not connected. The $\overline{\text{SHDN}}$ pin cannot be driven below GND unless tied to the IN pin. If the $\overline{\text{SHDN}}$ pin is driven below GND while IN is powered, the output will turn on. $\overline{\text{SHDN}}$ pin logic cannot be referenced to a negative rail.

GND (Pins 2, 3, 4/Pin 6): Ground. Connect the bottom of the resistor divider that sets output voltage directly to GND for the best regulation.

IN (Pin 5/Pin 4): Input. The IN pin supplies power to the device. The LT3008 requires a bypass capacitor at IN if the device is more than six inches away from the main input filter capacitor. In general, the output impedance of a battery rises with frequency, so it is advisable to include a bypass capacitor in battery-powered circuits. A bypass capacitor in the range of 0.1 μF to 10 μF will suffice. The LT3008 withstands reverse voltages on the IN pin with respect to ground and the OUT pin. In the case of a reversed input, which occurs with a battery plugged in backwards, the LT3008 acts as if a blocking diode is in series with its input. No reverse current flows into the LT3008 and no reverse voltage appears at the load. The device protects both itself and the load.

OUT (Pin 6/Pins 2, 3): Output. This pin supplies power to the load. Use a minimum output capacitor of 2.2 μF to prevent oscillations. Large load transient applications require larger output capacitors to limit peak voltage transients. See the Applications Information section for more information on output capacitance and reverse output characteristics.

ADJ (Pin 7/Pin 1): Adjust. This pin is the error amplifier's inverting terminal. Its 400pA typical input bias current flows out of the pin (see curve of ADJ Pin Bias Current vs Temperature in the Typical Performance Characteristics section). The ADJ pin voltage is 600mV referenced to GND and the output voltage range is 600mV to 44.5V.

NC (Pin 8, TSOT-23 Package Only): No Connect. Pin 8 is an NC pin in the TSOT-23 package. This pin is not tied to any internal circuitry. It may be floated, tied to V_{IN} or tied to GND.

Exposed Pad (Pin 7, DFN Package Only): Ground. The Exposed Pad (backside) of the DFN package is an electrical connection to GND. To ensure optimum performance, solder Pin 7 to the PCB and tie directly to Pin 6.

APPLICATIONS INFORMATION

The LT3008 is a low dropout linear regulator with ultra-low quiescent current and shutdown. Quiescent current is extremely low at 3µA and drops well below 1µA in shutdown. The device supplies up to 20mA of output current. Dropout voltage at 20mA is typically 300mV. The LT3008 incorporates several protection features, making it ideal for use in battery-powered systems. The device protects itself against both reverse-input and reverse-output voltages. In battery backup applications, where a backup battery holds up the output when the input is pulled to ground, the LT3008 acts as if a blocking diode is in series with its output and prevents reverse current flow. In applications where the regulator load returns to a negative supply, the output can be pulled below ground by as much as 50V without affecting startup or normal operation.

Adjustable Operation

The LT3008 has an output voltage range of 0.6V to 44.5V. Figure 1 shows that output voltage is set by the ratio of two external resistors. The IC regulates the output to maintain the ADJ pin voltage at 600mV referenced to ground. The current in R1 equals 600mV/R1 and the current in R2 is the current in R1 minus the ADJ pin bias current. The ADJ pin bias current, typically 400pA at 25°C, flows out of the pin. Calculate the output voltage using the formula in Figure 1. An R1 value of 619k sets the divider current to 0.97µA. Do not make R1's value any greater than 619k to minimize output voltage errors due to the ADJ pin bias current and to insure stability under minimum load conditions. In shutdown, the output turns off and the divider current is zero. Curves of ADJ Pin Voltage vs Temperature and ADJ Pin Bias Current vs Temperature appear in the

Typical Performance Characteristics.

Specifications for output voltages greater than 0.6V are proportional to the ratio of the desired output voltage to 0.6V: $V_{OUT}/0.6V$. For example, load regulation for an output current change of 100µA to 20mA is -0.5mV typical at $V_{OUT} = 0.6V$. At $V_{OUT} = 5V$, load regulation is:

$$\frac{5V}{0.6V} \cdot (-0.5mV) = -4.17mV$$

Table 1 shows resistor divider values for some common output voltages with a resistor divider current of about 1µA.

Table 1. Output Voltage Resistor Divider Values

V _{OUT}	R1	R2
1V	604k	402k
1.2V	590k	590k
1.5V	590k	887k
1.8V	590k	1.18M
2.5V	590k	1.87M
3V	590k	2.37M
3.3V	619k	2.8M
5V	590k	4.32M

Because the ADJ pin is relatively high impedance (depending on the resistor divider used), stray capacitances at this pin should be minimized. Special attention should be given to any stray capacitances that can couple external signals onto the ADJ pin producing undesirable output transients or ripple.

$$V_{OUT} = 600mV \cdot (1 + R2/R1) - (I_{ADJ} \cdot R2)$$

$$V_{ADJ} = 600mV$$

$$I_{ADJ} = 0.4nA \text{ at } 25^{\circ}C$$

$$OUTPUT \text{ RANGE} = 0.6V \text{ to } 44.5V$$

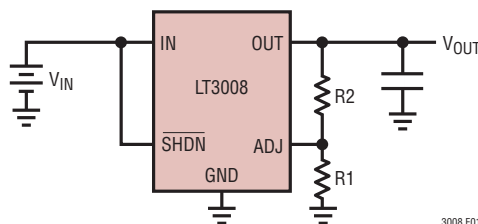

Figure 1. Adjustable Operation

3008 F01

APPLICATIONS INFORMATION

Extra care should be taken in assembly when using high valued resistors. Small amounts of board contamination can lead to significant shifts in output voltage. Appropriate post-assembly board cleaning measures should be implemented to prevent board contamination. If the board is to be subjected to humidity cycling or if board cleaning measures cannot be guaranteed, consideration should be given to using resistors an order of magnitude smaller than in Table 1 to prevent contamination from causing unwanted shifts in the output voltage.

Output Capacitance and Transient Response

The LT3008 is stable with a wide range of output capacitors. The ESR of the output capacitor affects stability, most notably with small capacitors. Use a minimum output capacitor of 2.2 μ F with an ESR of 3 Ω or less to prevent oscillations. The LT3008 is a micropower device and output load transient response is a function of output capacitance. Larger values of output capacitance decrease the peak deviations and provide improved transient response for larger load current changes.

Give extra consideration to the use of ceramic capacitors. Manufacturers make ceramic capacitors with a variety of

dielectrics, each with different behavior across temperature and applied voltage. The most common dielectrics are specified with EIA temperature characteristic codes of Z5U, Y5V, X5R and X7R. The Z5U and Y5V dielectrics provide high C-V products in a small package at low cost, but exhibit strong voltage and temperature coefficients as shown in Figures 2 and 3. When used with a 5V regulator, a 16V 10 μ F Y5V capacitor can exhibit an effective value as low as 1 μ F to 2 μ F for the DC bias voltage applied and over the operating temperature range. The X5R and X7R dielectrics yield more stable characteristics and are more suitable for use as the output capacitor. The X7R type has better stability across temperature, while the X5R is less expensive and is available in higher values. One must still exercise care when using X5R and X7R capacitors; the X5R and X7R codes only specify operating temperature range and maximum capacitance change over temperature. Capacitance change due to DC bias with X5R and X7R capacitors is better than Y5V and Z5U capacitors, but can still be significant enough to drop capacitor values below appropriate levels. Capacitor DC bias characteristics tend to improve as component case size increases, but expected capacitance at operating voltage should be verified.

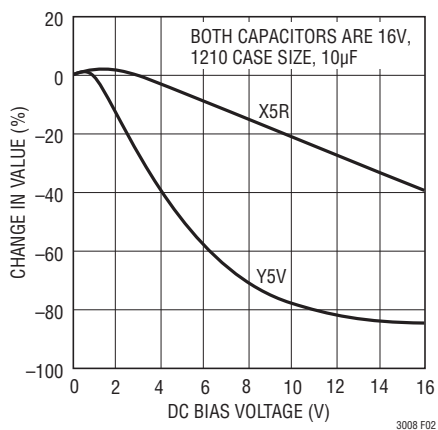

Figure 2. Ceramic Capacitor DC Bias Characteristics

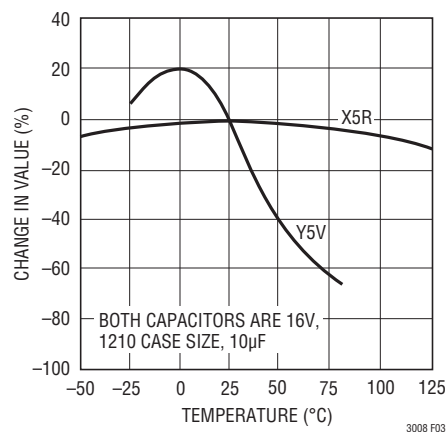

Figure 3. Ceramic Capacitor Temperature Characteristics

APPLICATIONS INFORMATION

Voltage and temperature coefficients are not the only sources of problems. Some ceramic capacitors have a piezoelectric response. A piezoelectric device generates voltage across its terminals due to mechanical stress, similar to the way a piezoelectric accelerometer or microphone works. For a ceramic capacitor, the stress can be induced by vibrations in the system or thermal transients. The resulting voltages produced can cause appreciable amounts of noise, especially when a ceramic capacitor is used for noise bypassing. A ceramic capacitor produced Figure 4's trace in response to light tapping from a pencil. Similar vibration induced behavior can masquerade as increased output voltage noise.

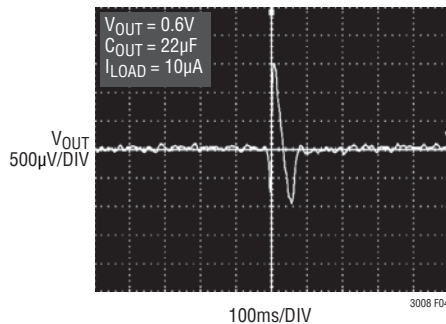

Figure 4. Noise Resulting from Tapping on a Ceramic Capacitor

Thermal Considerations

The LT3008's maximum rated junction temperature of 125°C limits its power-handling capability. Two components comprise the power dissipated by the device:

1. Output current multiplied by the input/output voltage differential: $I_{OUT} \cdot (V_{IN} - V_{OUT})$
2. GND pin current multiplied by the input voltage: $I_{GND} \cdot V_{IN}$

GND pin current is found by examining the GND Pin Current curves in the Typical Performance Characteristics section. Power dissipation is equal to the sum of the two components listed prior.

The LT3008 regulator has internal thermal limiting designed to protect the device during overload conditions. For continuous normal conditions, do not exceed the maximum junction temperature rating of 125°C. Carefully consider all sources of thermal resistance from junction to ambient including other heat sources mounted in proximity to the LT3008. For surface mount devices, heat sinking is accomplished by using the heat spreading capabilities of the PC board and its copper traces. Copper board stiffeners and plated through-holes can also be used to spread the heat generated by power devices.

APPLICATIONS INFORMATION

The following tables list thermal resistance for several different board sizes and copper areas. All measurements were taken in still air on 3/32" FR-4 two-layer boards with one ounce copper.

PCB layers, copper weight, board layout and thermal vias affect the resultant thermal resistance. Although Tables 2 and 3 provide thermal resistance numbers for 2-layer boards with 1 ounce copper, modern multi-layer PCBs provide better performance than found in these tables. For example, a 4-layer, 1 ounce copper PCB board with 3 thermal vias from the DFN exposed backside or the 3 fused TSOT-23 GND pins to inner layer GND planes achieves 45°C/W thermal resistance. Demo circuit DC 1388A's board layout achieves this 45°C/W performance. This is approximately a 30% improvement over the lowest numbers shown in Tables 2 and 3.

Table 2: Measured Thermal Resistance for DC Package

COPPER AREA		BOARD AREA	THERMAL RESISTANCE (JUNCTION-TO-AMBIENT)
TOPSIDE*	BACKSIDE		
2500mm ²	2500mm ²	2500mm ²	65°C/W
1000mm ²	2500mm ²	2500mm ²	70°C/W
225mm ²	2500mm ²	2500mm ²	75°C/W
100mm ²	2500mm ²	2500mm ²	80°C/W
50mm ²	2500mm ²	2500mm ²	85°C/W

*Device is mounted on the topside.

Table 3: Measured Thermal Resistance for TSOT-23 Package

COPPER AREA		BOARD AREA	THERMAL RESISTANCE (JUNCTION-TO-AMBIENT)
TOPSIDE*	BACKSIDE		
2500mm ²	2500mm ²	2500mm ²	65°C/W
1000mm ²	2500mm ²	2500mm ²	67°C/W
225mm ²	2500mm ²	2500mm ²	70°C/W
100mm ²	2500mm ²	2500mm ²	75°C/W
50mm ²	2500mm ²	2500mm ²	85°C/W

*Device is mounted on the topside.

Calculating Junction Temperature

Example: Given an output voltage of 3.3V, an input voltage range of 12V ±5%, an output current range of 0mA to 20mA and a maximum ambient temperature of 85°C, what will the maximum junction temperature be for an application using the DC package?

The power dissipated by the device is equal to:

$$I_{OUT(MAX)} (V_{IN(MAX)} - V_{OUT}) + I_{GND} (V_{IN(MAX)})$$

where,

$$I_{OUT(MAX)} = 20mA$$

$$V_{IN(MAX)} = 12.6V$$

$$I_{GND} \text{ at } (I_{OUT} = 20mA, V_{IN} = 12.6V) = 0.3mA$$

So,

$$P = 20mA(12.6V - 3.3V) + 0.3mA(12.6V) = 189.8mW$$

The thermal resistance ranges from 65°C/W to 85°C/W depending on the copper area. So the junction temperature rise above ambient approximately equals:

$$0.1898W(75°C/W) = 14.2°C$$

The maximum junction temperature equals the maximum junction temperature rise above ambient plus the maximum ambient temperature or:

$$T_{J(MAX)} = 85°C + 14.2°C = 99.2°C$$

APPLICATIONS INFORMATION

Protection Features

The LT3008 incorporates several protection features that make it ideal for use in battery-powered circuits. In addition to the normal protection features associated with monolithic regulators, such as current limiting and thermal limiting, the device also protects against reverse-input voltages, reverse-output voltages and reverse output-to-input voltages.

Current limit protection and thermal overload protection protect the device against current overload conditions at the output of the device. For normal operation, do not exceed a junction temperature of 125°C.

The IN pin withstands reverse voltages of 50V. The device limits current flow to less than 20µA (typically less than 1µA) and no negative voltage appears at OUT. The device protects both itself and the load against batteries that are plugged in backwards.

The $\overline{\text{SHDN}}$ pin cannot be driven below GND unless tied to the IN pin. If the $\overline{\text{SHDN}}$ pin is driven below GND while IN is powered, the output will turn on. $\overline{\text{SHDN}}$ pin logic cannot be referenced to a negative rail.

The LT3008 incurs no damage if OUT is pulled below ground. If IN is left open circuit or grounded, OUT can be pulled below ground by 50V. No current flows from the pass transistor connected to OUT. However, current flows in (but is limited by) the resistor divider that sets output

voltage. Current flows from the bottom resistor in the divider and from the ADJ pin's internal clamp through the top resistor in the divider to the external circuitry pulling OUT below ground. If IN is powered by a voltage source, OUT sources current equal to its current limit capability and the LT3008 protects itself by thermal limiting if necessary. In this case, grounding the $\overline{\text{SHDN}}$ pin turns off the LT3008 and stops OUT from sourcing current.

The LT3008 incurs no damage if the ADJ pin is pulled above or below ground by 50V. If IN is left open circuit or grounded, ADJ acts like a 100k resistor in series with a diode when pulled above or below ground.

In circuits where a backup battery is required, several different input/output conditions can occur. The output voltage may be held up while the input is either pulled to ground, pulled to some intermediate voltage or is left open circuit. Current flow back into the output follows the curve shown in Figure 5.

If the LT3008 IN pin is forced below the OUT pin or the OUT pin is pulled above the IN pin, input current typically drops to less than 1µA. This occurs if the LT3008 input is connected to a discharged (low voltage) battery and either a backup battery or a second regulator circuit holds up the output. The state of the $\overline{\text{SHDN}}$ pin has no effect in the reverse current if OUT is pulled above IN.

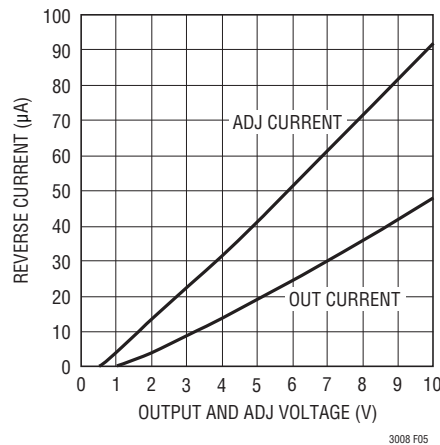
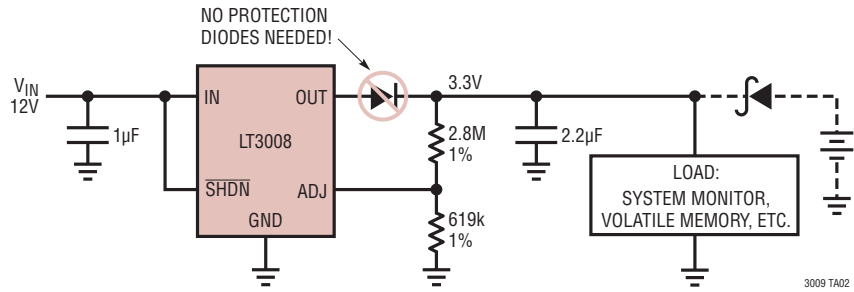

Figure 5. Reverse Output Current

TYPICAL APPLICATIONS

Keep-Alive Power Supply



Last-Gasp Circuit

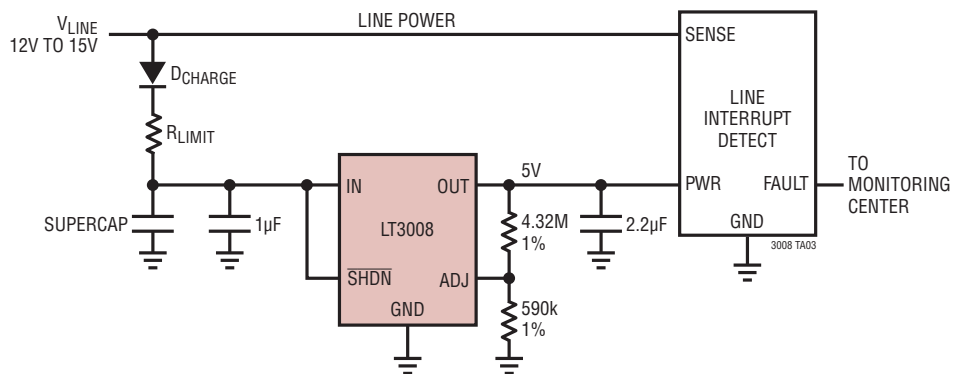

PACKAGE DESCRIPTION

DC Package
6-Lead Plastic DFN (2mm × 2mm)
 (Reference LTC DWG # 05-08-1703)

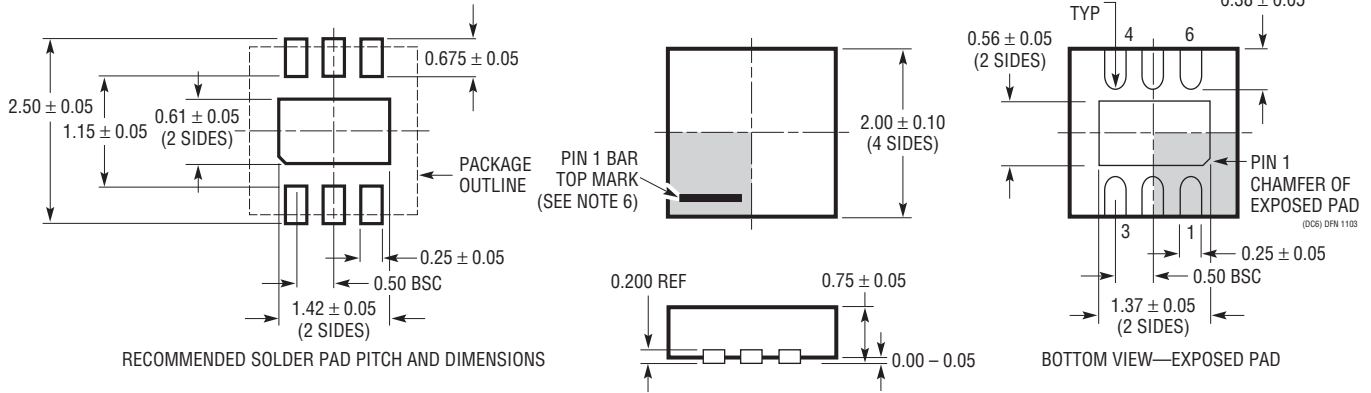

NOTE:

1. DRAWING TO BE MADE A JEDEC PACKAGE OUTLINE M0-229 VARIATION OF (WCCD-2)
2. DRAWING NOT TO SCALE
3. ALL DIMENSIONS ARE IN MILLIMETERS
4. DIMENSIONS OF EXPOSED PAD ON BOTTOM OF PACKAGE DO NOT INCLUDE MOLD FLASH. MOLD FLASH, IF PRESENT, SHALL NOT EXCEED 0.15mm ON ANY SIDE
5. EXPOSED PAD SHALL BE SOLDER PLATED
6. SHADED AREA IS ONLY A REFERENCE FOR PIN 1 LOCATION ON THE TOP AND BOTTOM OF PACKAGE

PACKAGE DESCRIPTION

TS8 Package
8-Lead Plastic TSOT-23
 (Reference LTC DWG # 05-08-1639 Rev 0)

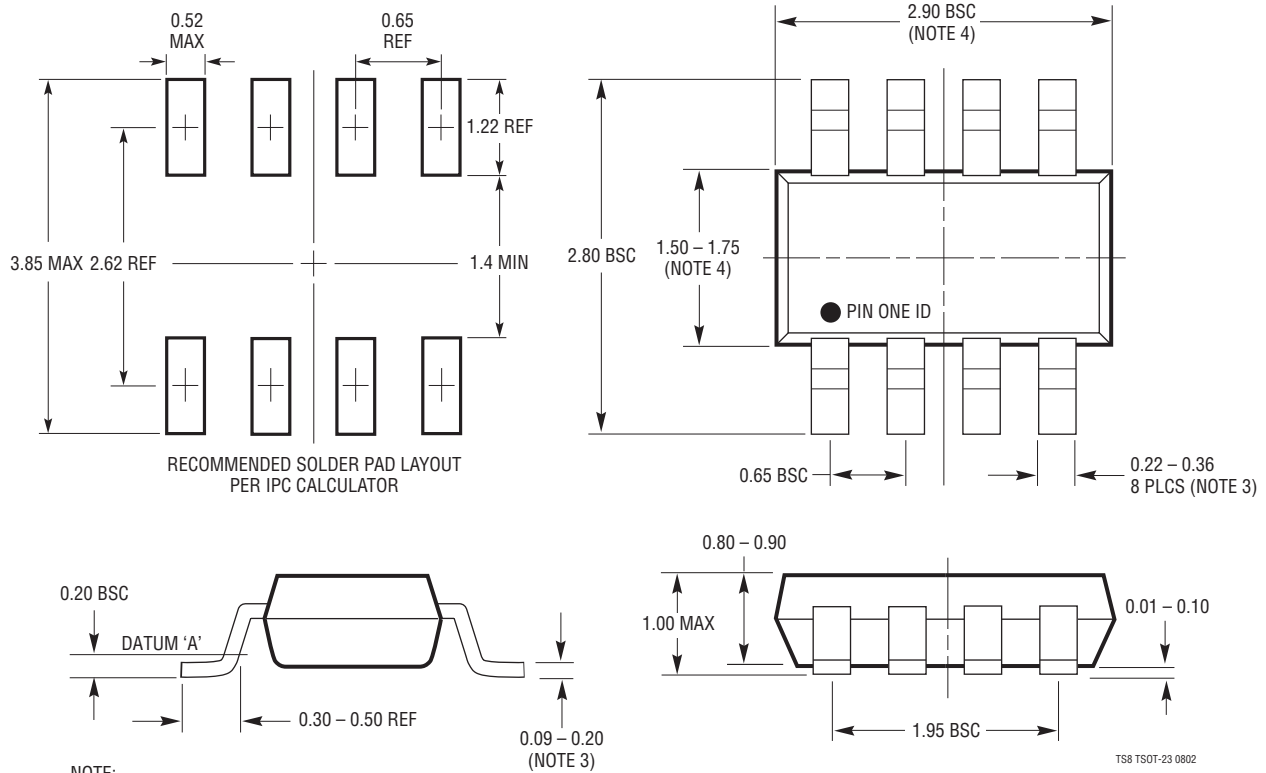

- NOTE:
1. DIMENSIONS ARE IN MILLIMETERS
 2. DRAWING NOT TO SCALE
 3. DIMENSIONS ARE INCLUSIVE OF PLATING
 4. DIMENSIONS ARE EXCLUSIVE OF MOLD FLASH AND METAL BURR
 5. MOLD FLASH SHALL NOT EXCEED 0.254mm
 6. JEDEC PACKAGE REFERENCE IS MO-193

TS8 TSOT-23 0802

TYPICAL APPLICATION

Low Duty Cycle Applications

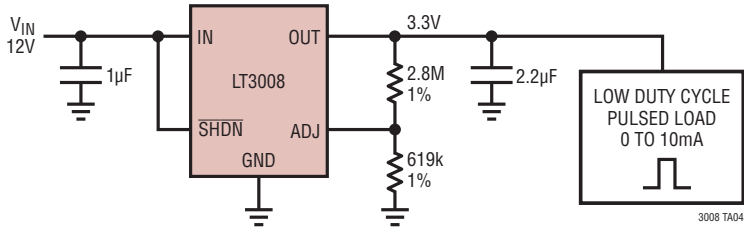

Average Power Savings for Low Duty Cycle Applications 0mA to 10mA Pulsed Load, $V_{IN} = 12V$

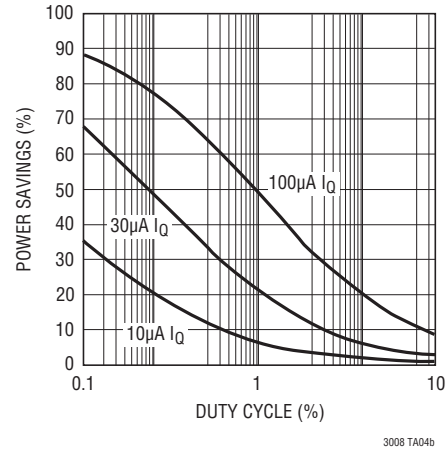

RELATED PARTS

PART NUMBER	DESCRIPTION	COMMENTS
LT1761	100mA, Low Noise Micropower LDO	V_{IN} : 1.8V to 20V, $V_{OUT} = 1.22V$, $V_{DO} = 0.3V$, $I_Q = 20\mu A$, $I_{SD} < 1\mu A$, Low Noise $< 20\mu V_{RMS}$, Stable with 1µF Ceramic Capacitors, ThinSOT™ Package
LT1762	150mA, Low Noise Micropower LDO	V_{IN} : 1.8V to 20V, $V_{OUT} = 1.22V$, $V_{DO} = 0.3V$, $I_Q = 25\mu A$, $I_{SD} < 1\mu A$, Low Noise $< 20\mu V_{RMS}$, MS8 Package
LT1763	500mA, Low Noise Micropower LDO	V_{IN} : 1.8V to 20V, $V_{OUT} = 1.22V$, $V_{DO} = 0.3V$, $I_Q = 30\mu A$, $I_{SD} < 1\mu A$, Low Noise $< 20\mu V_{RMS}$, S8 Package
LT1764/LT1764A	3A, Low Noise, Fast Transient Response LDOs	V_{IN} : 2.7V to 20V, $V_{OUT} = 1.21V$, $V_{DO} = 0.34V$, $I_Q = 1mA$, $I_{SD} < 1\mu A$, Low Noise $< 40\mu V_{RMS}$, "A" Version Stable with Ceramic Capacitors, DD and TO220-5 Packages
LT1962	300mA, Low Noise Micropower LDO	V_{IN} : 1.8V to 20V, $V_{OUT(MIN)} = 1.22V$, $V_{DO} = 0.27V$, $I_Q = 30\mu A$, $I_{SD} < 1\mu A$, Low Noise: $< 20\mu V_{RMS}$, MS8 Package
LT1963/LT1963A	1.5A, Low Noise, Fast Transient Response LDOs	V_{IN} : 2.1V to 20V, $V_{OUT(MIN)} = 1.21V$, $V_{DO} = 0.34V$, $I_Q = 1mA$, $I_{SD} < 1\mu A$, Low Noise: $< 40\mu V_{RMS}$, "A" Version Stable with Ceramic Capacitors, DD, TO220-5, SOT223 and S8 Packages
LT3009	20mA, 3µA I_Q Micropower LDO	V_{IN} : 1.6V to 20V, Low I_Q : 3µA, $V_{DO} = 0.28V$, 2mm × 2mm DFN and SC-70-8 Packages
LT3020	100mA, Low Voltage VLDO	V_{IN} : 0.9V to 10V, $V_{OUT(MIN)} = 0.20V$, $V_{DO} = 0.15V$, $I_Q = 120\mu A$, $I_{SD} < 1\mu A$, 3mm × 3mm DFN and MS8 Packages
LT3021	500mA, Low Voltage VLDO	V_{IN} : 0.9V to 10V, $V_{OUT(MIN)} = 0.20V$, $V_{DO} = 0.16V$, $I_Q = 120\mu A$, $I_{SD} < 3\mu A$, 5mm × 5mm DFN and S08 Packages
LT3080/ LT3080-1	1.1A, Parallelable, Low Noise, Low Dropout Linear Regulator	300mV Dropout Voltage (2-supply operation), Low Noise: 40µVRMS, V_{IN} : 1.2V to 36V, V_{OUT} : 0V to 35.7V, current-based reference with 1-resistor V_{OUT} set; directly parallelable (no op amp required), stable with ceramic caps, TO-220, SOT-223, MSOP and 3 × 3 DFN Packages; "-1" version has integrated internal ballast resistor
LT3085	500mA, Parallelable, Low Noise, Low Dropout Linear Regulator	275mV Dropout Voltage (2-supply operation), Low Noise: 40µVRMS, V_{IN} : 1.2V to 36V, V_{OUT} : 0V to 35.7V, current-based reference with 1-resistor V_{OUT} set; directly parallelable (no op amp required), stable with ceramic caps, MSOP-8 and 2 × 3 DFN packages

ThinSOT is a trademark of Linear Technology Corporation.