

# LT1□97A series

## 1608 Size, Super Thin Type(0.6mm), Leadless Chip LED Devices

### Outline Dimensions

(Unit : mm)

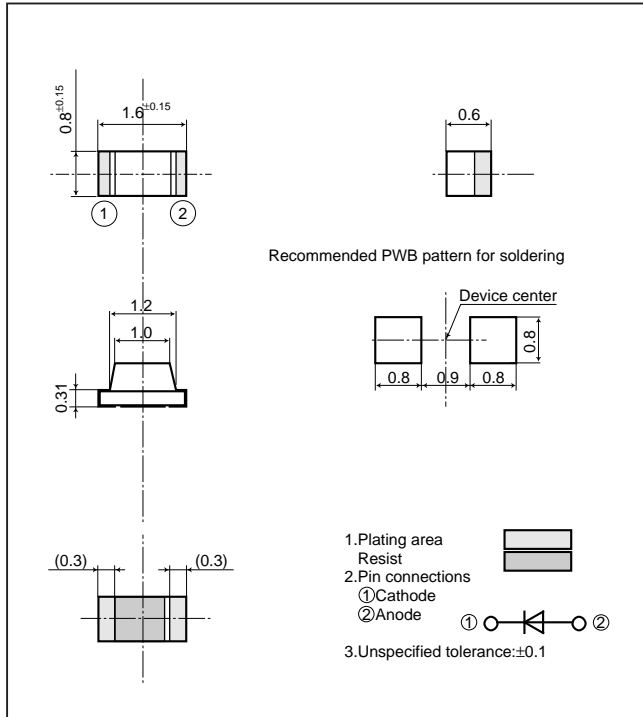

U type: There is Anode mark on the device because polarity faces in the opposite direction.

### Radiation Diagram

(Ta=25°C)

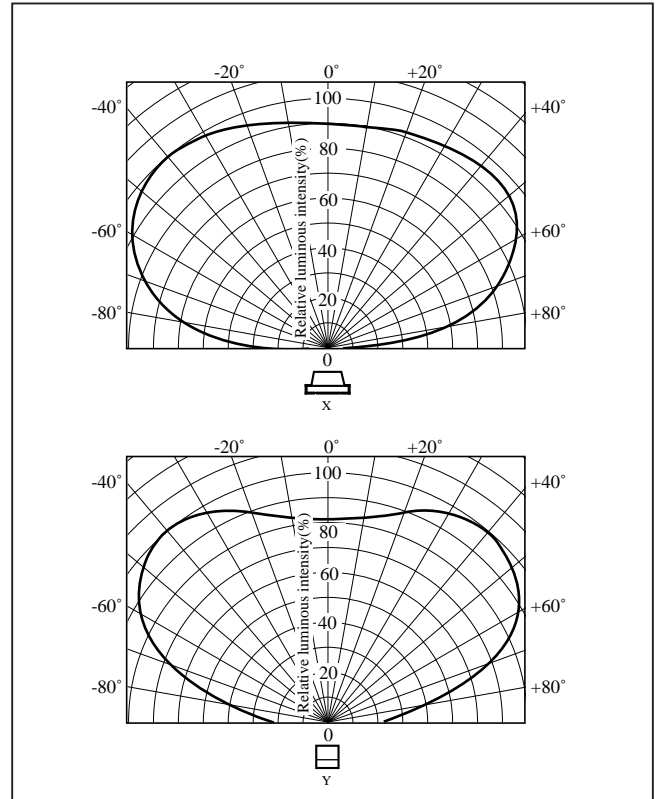

(Ta=25°C)

### Absolute Maximum Ratings

Model No.	Radiation color	Radiation material	Power dissipation P (mW)	Forward current I <sub>F</sub> (mA)	Peak forward current I <sub>FM</sub> *1 (mA)	Derating factor (mA/°C)		Reverse voltage V <sub>R</sub> (V)	Operating temperature T <sub>opr</sub> (°C)	Storage temperature T <sub>stg</sub> (°C)	Soldering temperature T <sub>sol</sub> *2 (°C)
						DC	Pulse				
LT1U97A	Red(Super-luminosity)	GaAlAs on GaAlAs	75	30	50	0.40	0.67	5	-30 to +85	-40 to +100	350
LT1P97A	Red	GaP	23	10	50	0.13	0.67	5	-30 to +85	-40 to +100	350
LT1D97A	Red	GaAsP on GaP	84	30	50	0.40	0.67	5	-30 to +85	-40 to +100	350
LT1S97A	Sunset orange	GaAsP on GaP	84	30	50	0.40	0.67	5	-30 to +85	-40 to +100	350
LT1H97A	Yellow	GaAsP on GaP	84	30	50	0.40	0.67	5	-30 to +85	-40 to +100	350
LT1E97A	Yellow-green	GaP	84	30	50	0.40	0.67	5	-30 to +85	-40 to +100	350
LT1K97A	Green	GaP	84	30	50	0.40	0.67	5	-30 to +85	-40 to +100	350

\*1 Duty ratio=1/10, Pulse width=0.1ms

\*2 For 3s or less at the temperature of hand soldering. Temperature of reflow soldering is shown on the below page.

### Electro-optical Characteristics

(Ta=25°C)

Lens type	Model No.	Forward voltage V <sub>F</sub> (V)		Peak emission wavelength		Luminous intensity		Spectrum radiation bandwidth		Reverse current		Terminal capacitance		Page for characteristics diagrams
		TYP	MAX	λ <sub>p</sub> (nm) TYP	I <sub>F</sub> (mA)	I <sub>v</sub> (mcd) TYP	I <sub>F</sub> (mA)	Δλ(nm) TYP	I <sub>F</sub> (mA)	I <sub>R</sub> (μA) MAX	V <sub>R</sub> (V)	C <sub>t</sub> (pF) TYP	(MHz)	
Milky diffusion	LT1U97A	1.85	2.5	660	20	35.3	20	20	20	100	3	25	1	→
	LT1P97A	1.9	2.3	695	5	1.6	5	100	5	10	4	55	1	→
	LT1D97A	2.0	2.8	635	20	11.0	20	35	20	10	4	20	1	→
	LT1S97A	2.0	2.8	610	20	8.2	20	35	20	10	4	15	1	→
	LT1H97A	2.0	2.8	585	20	9.8	20	30	20	10	4	35	1	→
	LT1E97A	2.1	2.8	565	20	23.0	20	30	20	10	4	35	1	→
	LT1K97A	2.1	2.8	555	20	4.5	20	25	20	10	4	40	1	→

(Notice) • In the absence of confirmation by device specification sheets, SHARP takes no responsibility for any defects that may occur in equipment using any SHARP devices shown in catalogs, data books, etc. Contact SHARP in order to obtain the latest device specification sheets before using any SHARP device.

(Internet) • Data for sharp's optoelectronic/power device is provided for internet.(Address <http://www.sharp.co.jp/ecg/>)

# LED Lamp Characteristics Diagrams

## PR series

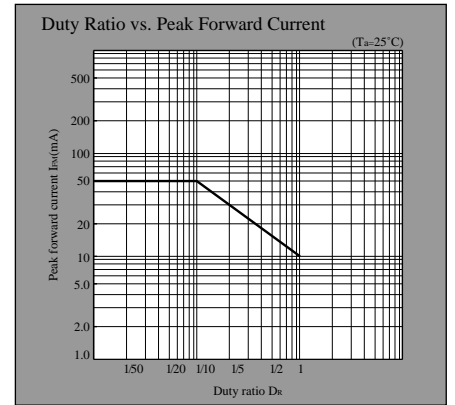
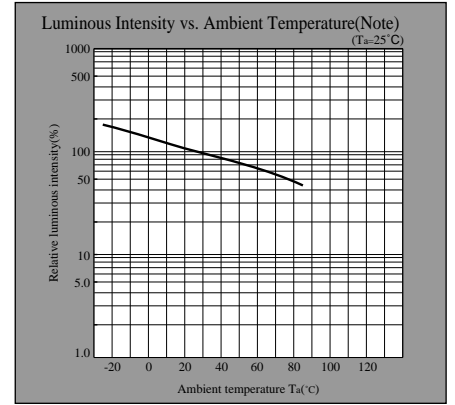

## HD series

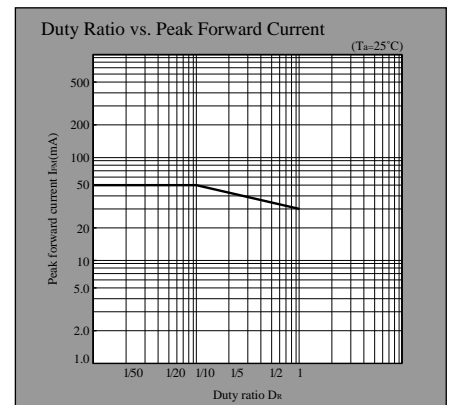
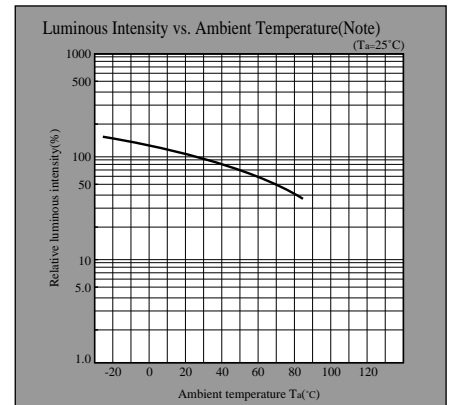

Note) Characteristics shown in diagrams are typical values. (not assurance value)

- (Notice) • In the absence of confirmation by device specification sheets, SHARP takes no responsibility for any defects that may occur in equipment using any SHARP devices shown in catalogs, data books, etc. Contact SHARP in order to obtain the latest device specification sheets before using any SHARP device.
- (Internet) • Data for sharp's optoelectronic/power device is provided for internet. (Address <http://www.sharp.co.jp/ecg/>)

# LED Lamp Characteristics Diagrams

## HS series

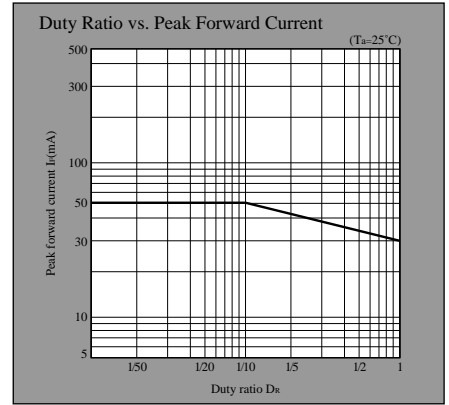
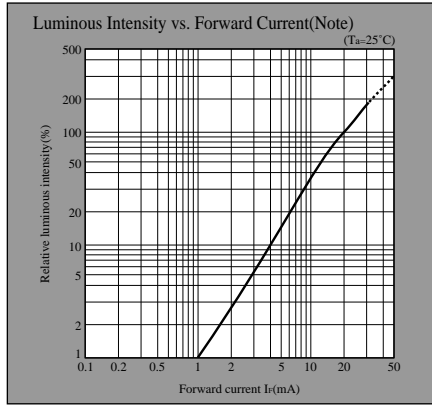
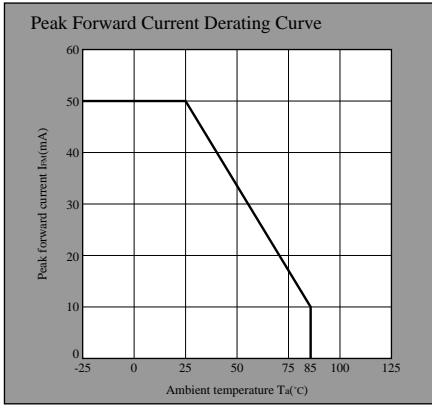
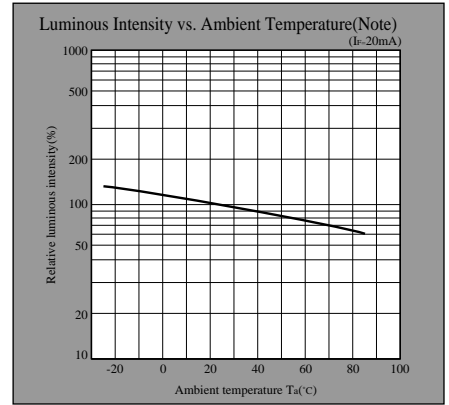
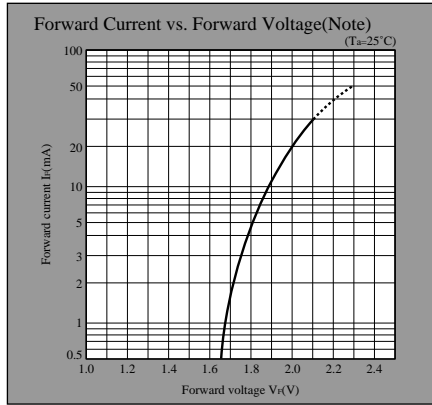

## HY series

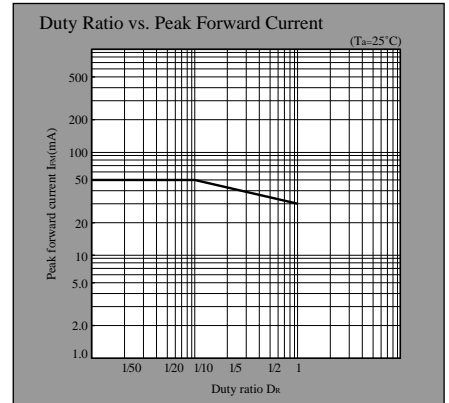
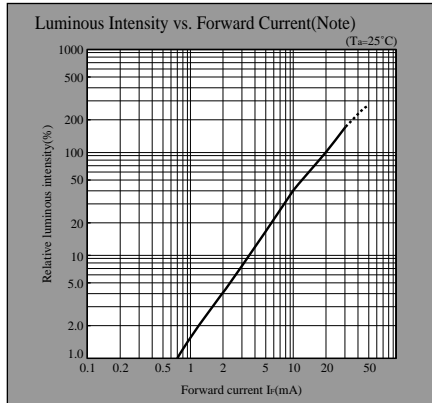
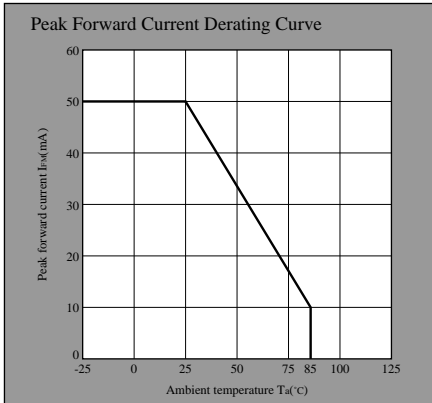
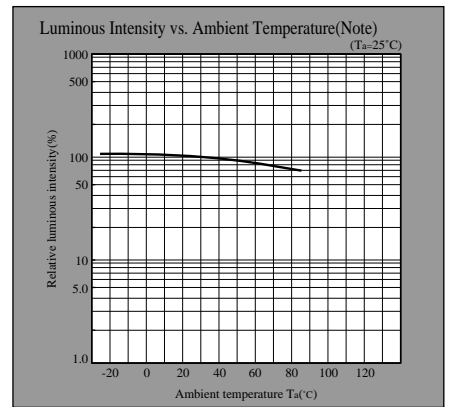
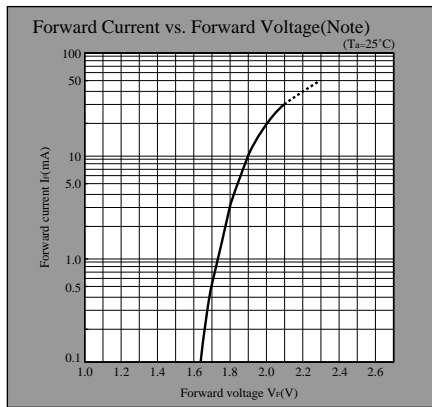
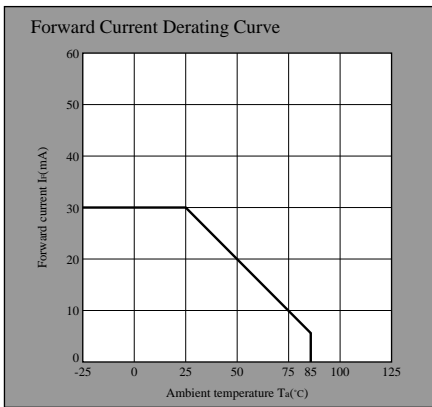

Note) Characteristics shown in diagrams are typical values. (not assurance value)

- (Notice) • In the absence of confirmation by device specification sheets, SHARP takes no responsibility for any defects that may occur in equipment using any SHARP devices shown in catalogs, data books, etc. Contact SHARP in order to obtain the latest device specification sheets before using any SHARP device.
- (Internet) • Data for sharp's optoelectronic/power device is provided for internet. (Address <http://www.sharp.co.jp/ecg/>)

# LED Lamp Characteristics Diagrams

## EG series

Forward Current Derating Curve



Forward Current vs. Forward Voltage(Note)



Luminous Intensity vs. Ambient Temperature(Note)

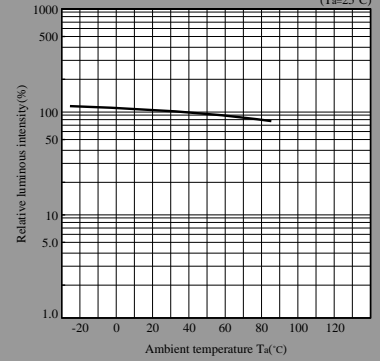

Peak Forward Current Derating Curve

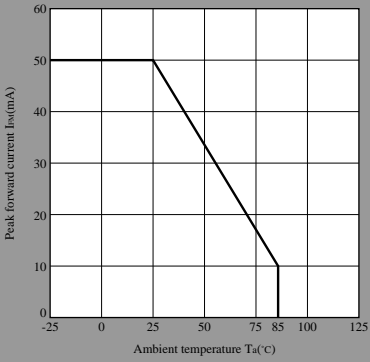

Luminous Intensity vs. Forward Current(Note)

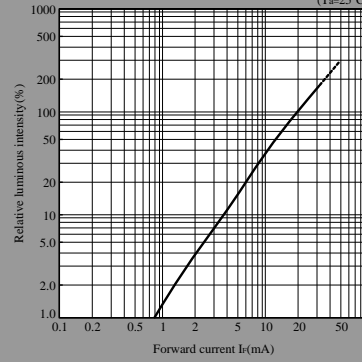

Duty Ratio vs. Peak Forward Current

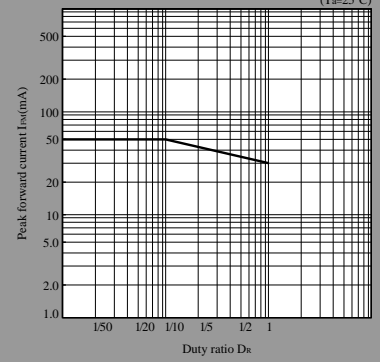

## KG series

Forward Current Derating Curve

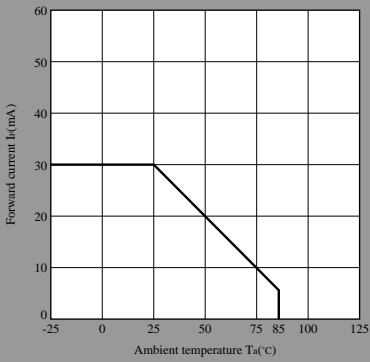

Forward Current vs. Forward Voltage(Note)

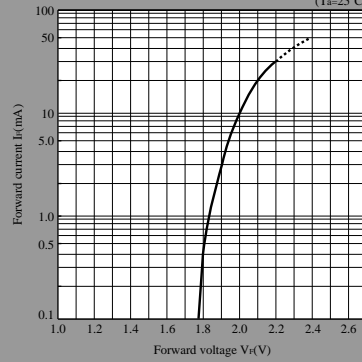

Luminous Intensity vs. Ambient Temperature(Note)

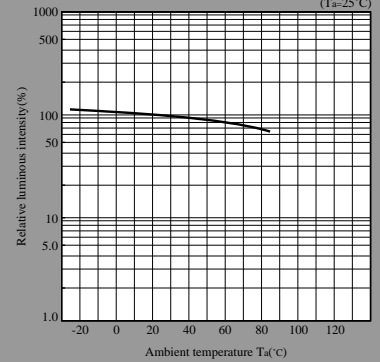

Peak Forward Current Derating Curve



Luminous Intensity vs. Forward Current(Note)



Duty Ratio vs. Peak Forward Current

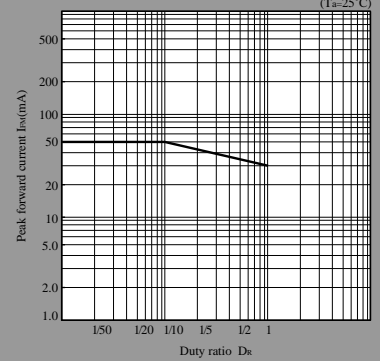

Note) Characteristics shown in diagrams are typical values. (not assurance value)

- (Notice) • In the absence of confirmation by device specification sheets, SHARP takes no responsibility for any defects that may occur in equipment using any SHARP devices shown in catalogs, data books, etc. Contact SHARP in order to obtain the latest device specification sheets before using any SHARP device.  
 (Internet) • Data for sharp's optoelectronic/power device is provided for internet.(Address <http://www.sharp.co.jp/ecg/>)

# UR series

## Forward Current Derating Curve

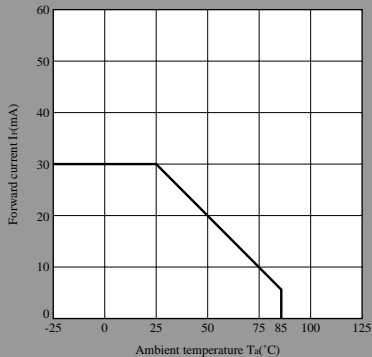

## Forward Current vs. Forward Voltage(Note)

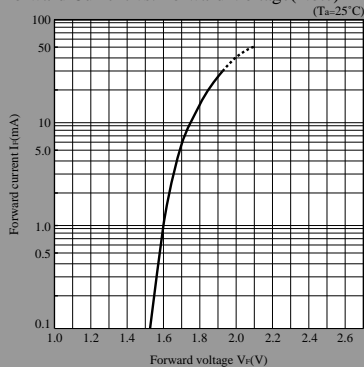

## Luminous Intensity vs. Ambient Temperature(Note)

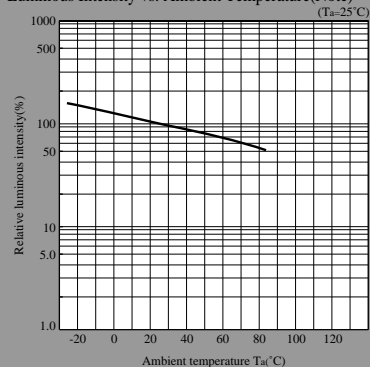

## Peak Forward Current Derating Curve

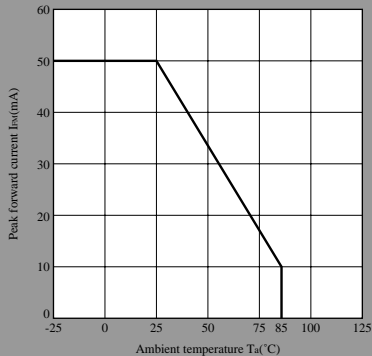

## Luminous Intensity vs. Forward Current(Note)

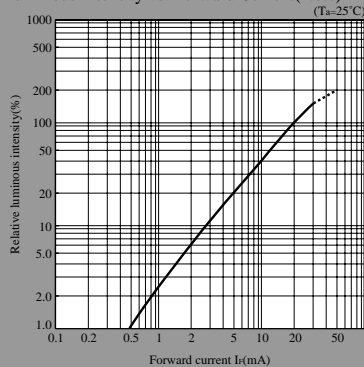

## Duty Ratio vs. Peak Forward Current

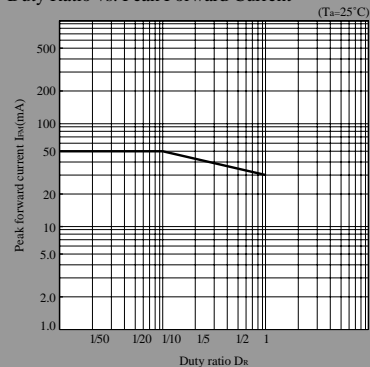

Note) Characteristics shown in diagrams are typical values. (not assurance value)