

LT1□□53A series

3.3X2.9mm, 1.1mm Thickness, Milky Diffusion, Dichromatic Chip LED Devices

Outline Dimensions

(Unit : mm)

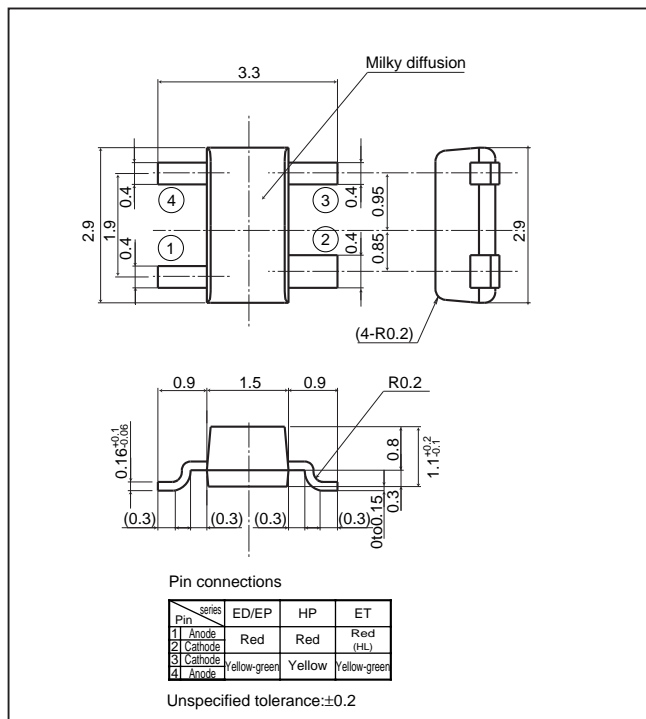

Radiation Diagram

(Ta=25°C)

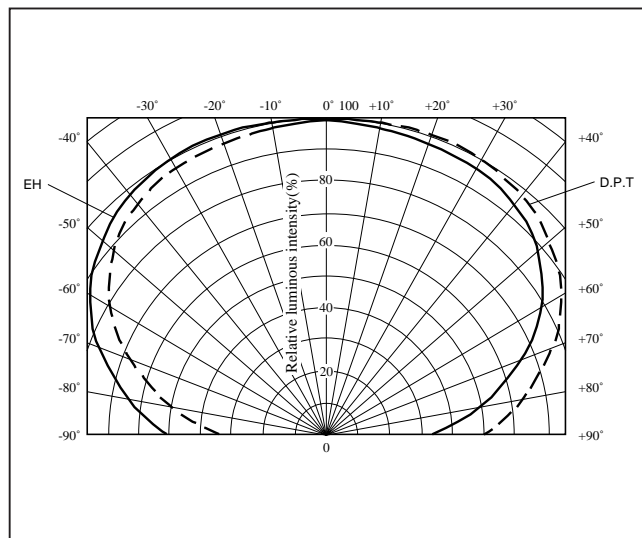

Absolute Maximum Ratings*

(Ta=25°C)

Model No.	Radiation color	Radiation material	Power dissipation P (mW)	Forward current I _F (mA)	Peak forward current I _{FM} ^{*1} (mA)	Derating factor (mA/°C)		Reverse voltage V _R (V)	Operating temperature T _{opr} (°C)	Storage temperature T _{stg} (°C)	Soldering temperature T _{sol} ^{*2} (°C)
						DC	Pulse				
LT1ET53A	Yellow-green	GaP	50	20	50	0.27	0.67	5	-25 to +85	-25 to +100	350
	Red(High-luminosity)	GaAlAs on GaAs	66	30	50	0.40	0.67	5	-25 to +85	-25 to +100	350
LT1ED53A	Yellow-green	GaP	50	20	50	0.27	0.67	5	-25 to +85	-25 to +100	350
	Red	GaAsP on GaP	85	30	50	0.40	0.67	5	-25 to +85	-25 to +100	350
LT1EP53A	Yellow-green	GaP	50	20	50	0.27	0.67	5	-25 to +85	-25 to +100	350
	Red	GaP	23	10	50	0.13	0.67	5	-25 to +85	-25 to +100	350
LT1HP53A	Yellow	GaAsP on GaP	50	20	50	0.27	0.67	5	-25 to +85	-25 to +100	350
	Red	GaP	23	10	50	0.13	0.67	5	-25 to +85	-25 to +100	350

* The value is specified under the condition that either color is lightened separately. When the both diodes are lightened simultaneously, the power dissipation of each diode should be less than the half of the value specified in this table.

*1 Duty ratio=1/10, Pulse width=0.1ms

*2 For 3s or less at the temperature of hand soldering. Temperature of reflow soldering is shown on the below page.

Electro-optical Characteristics

(Ta=25°C)

Lens type	Model No.	Radiation color	Forward voltage V _F (V)		Peak emission wavelength λ _p (nm)		Luminous intensity I _v (mcd)		Spectrum radiation bandwidth Δλ(nm)		Reverse current I _R (μA)		Terminal capacitance C _t (pF)		Page for characteristics diagrams
			TYP	MAX	TYP	I _F (mA)	TYP	I _F (mA)	TYP	I _F (mA)	MAX	V _R (V)	TYP	(MHz)	
Milky diffusion	LT1ET53A	Yellow-green	1.95	2.5	565	10	3.6	10	30	10	10	4	35	1	→
		Red(High-luminosity)	1.75	2.2	660	20	6.5	20	20	20	10	4	30	1	→
	LT1ED53A	Yellow-green	1.95	2.5	565	10	3.6	10	30	10	10	4	35	1	→
		Red	2.0	2.8	635	20	5.3	20	35	20	10	4	20	1	→
	LT1EP53A	Yellow-green	1.95	2.5	565	10	3.6	10	30	10	10	4	35	1	→
		Red	1.9	2.3	695	5	1.1	5	100	5	10	4	55	1	→
LT1HP53A	Yellow	1.9	2.5	585	10	3.1	10	30	10	10	4	35	1	→	
	Red	1.9	2.3	695	5	1.1	5	100	5	10	4	55	1	→	

(Notice) • In the absence of confirmation by device specification sheets, SHARP takes no responsibility for any defects that may occur in equipment using any SHARP devices shown in catalogs, data books, etc. Contact SHARP in order to obtain the latest device specification sheets before using any SHARP device.

(Internet) • Data for sharp's optoelectronic/power device is provided for internet.(Address <http://www.sharp.co.jp/ecg/>)

LED Lamp Characteristics Diagrams

PR series

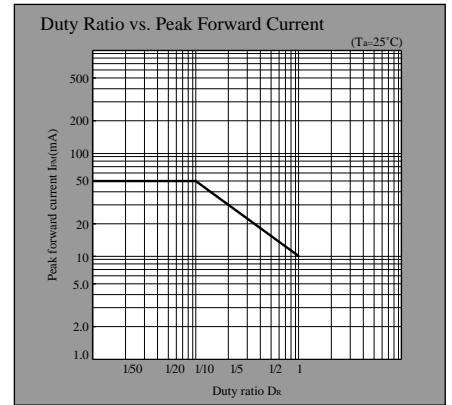
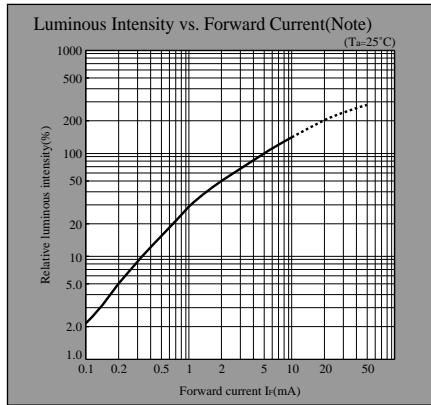
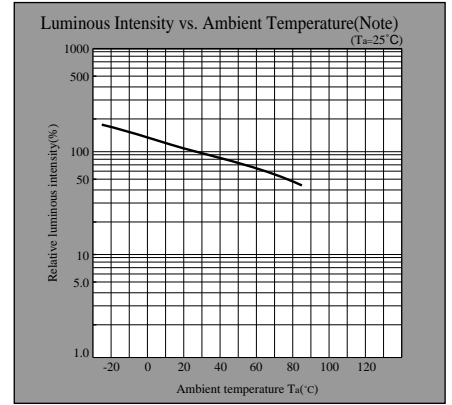
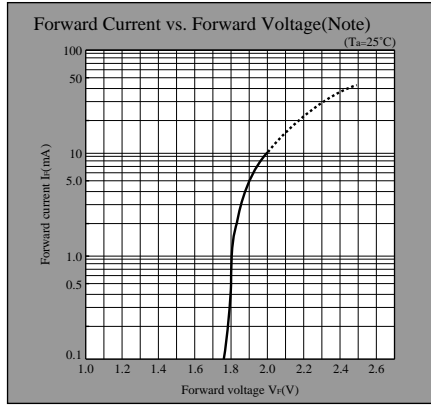

HD series

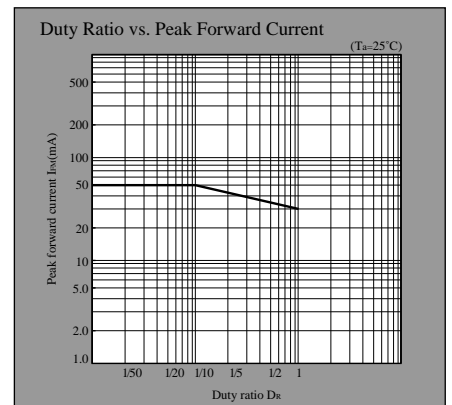
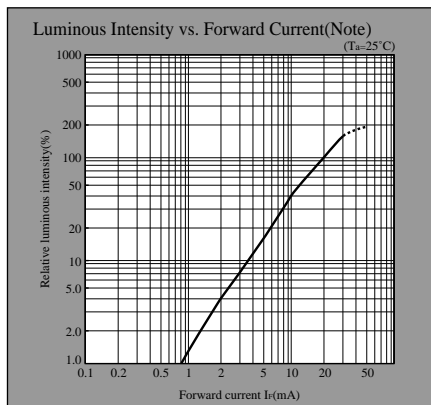
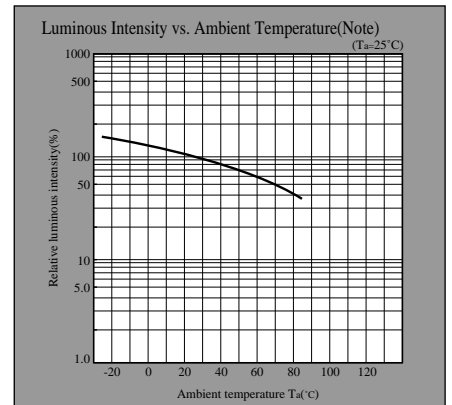
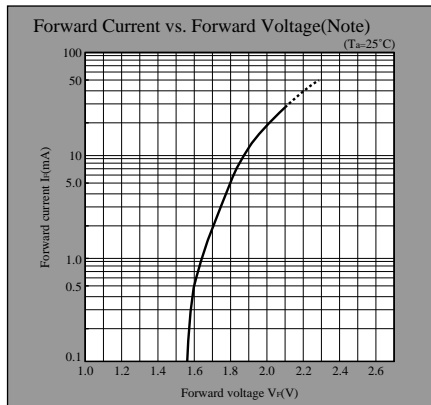

Note) Characteristics shown in diagrams are typical values. (not assurance value)

- (Notice) • In the absence of confirmation by device specification sheets, SHARP takes no responsibility for any defects that may occur in equipment using any SHARP devices shown in catalogs, data books, etc. Contact SHARP in order to obtain the latest device specification sheets before using any SHARP device.
- (Internet) • Data for sharp's optoelectronic/power device is provided for internet.(Address <http://www.sharp.co.jp/ecg/>)

TR series

Forward Current Derating Curve

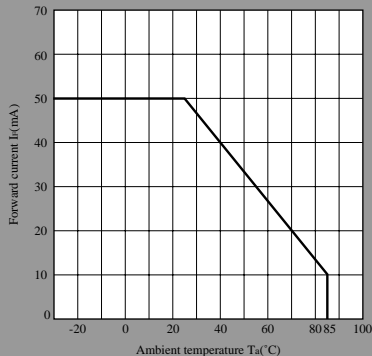

Forward Current vs. Forward Voltage(Note)

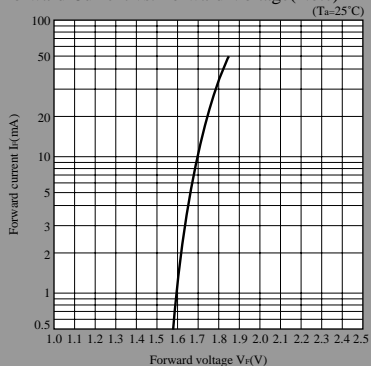

Luminous Intensity vs. Ambient Temperature(Note)

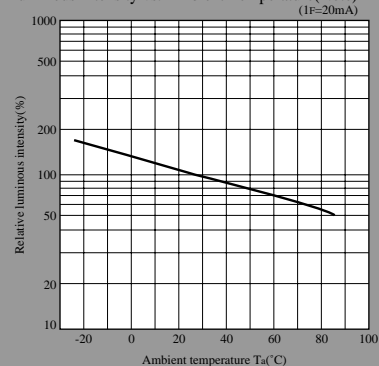

Peak Forward Current Derating Curve

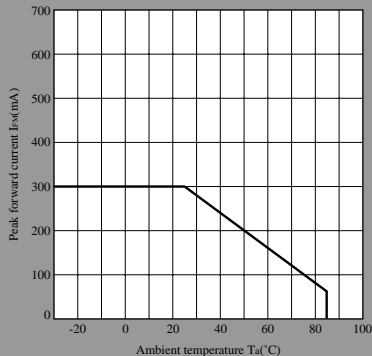

Luminous Intensity vs. Forward Current(Note)

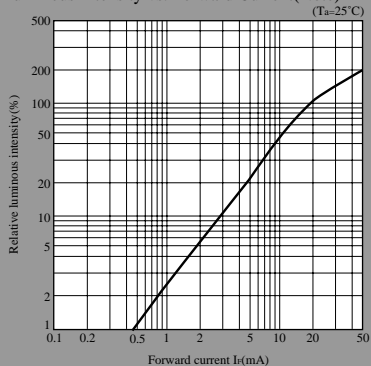

Duty Ratio vs. Peak Forward Current

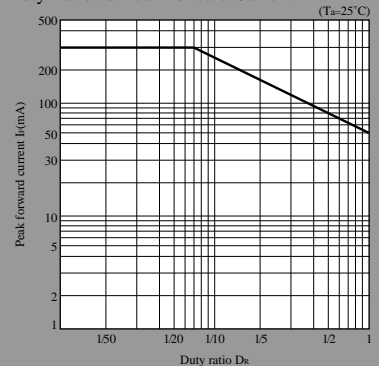

Note) Characteristics shown in diagrams are typical values. (not assurance value)

HY series

Forward Current Derating Curve

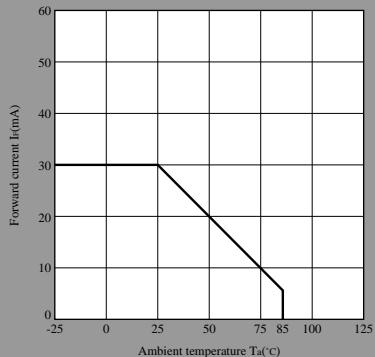

Forward Current vs. Forward Voltage(Note)

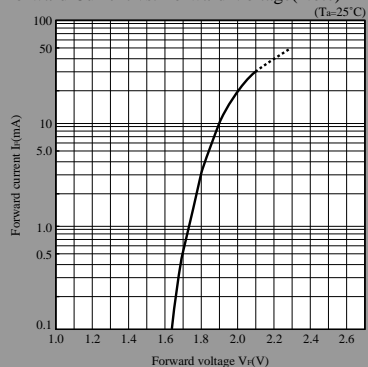

Luminous Intensity vs. Ambient Temperature(Note)

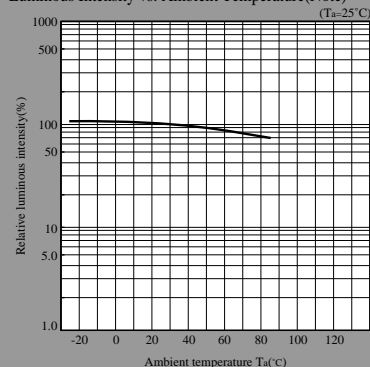

Peak Forward Current Derating Curve

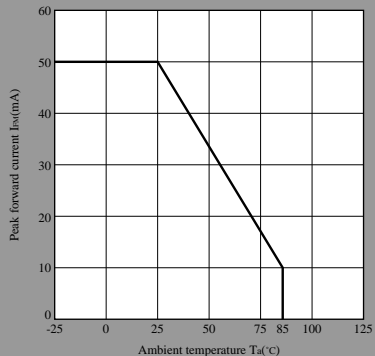

Luminous Intensity vs. Forward Current(Note)

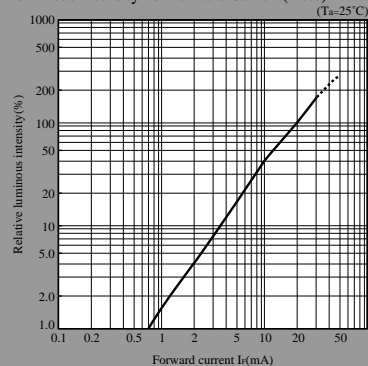

Duty Ratio vs. Peak Forward Current

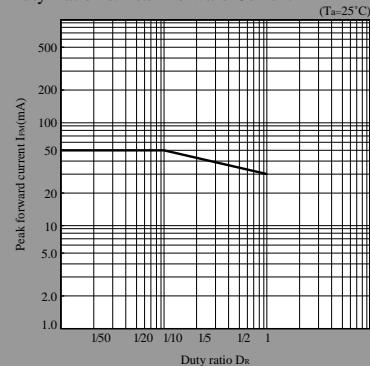

Note) Characteristics shown in diagrams are typical values. (not assurance value)

Forward Current Derating Curve

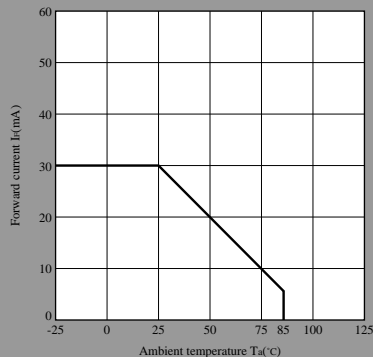

Forward Current vs. Forward Voltage(Note)

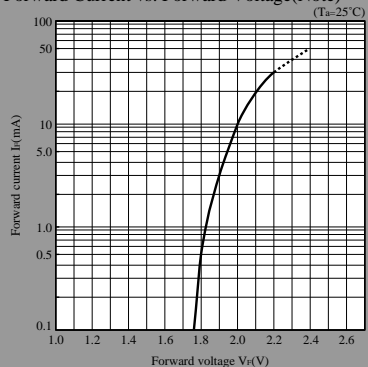

Luminous Intensity vs. Ambient Temperature(Note)

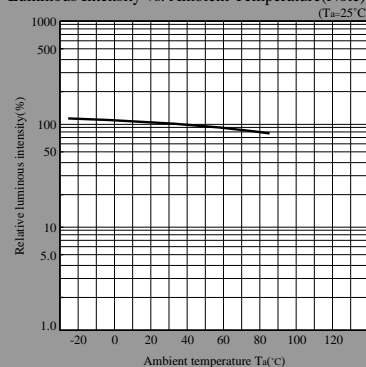

Peak Forward Current Derating Curve

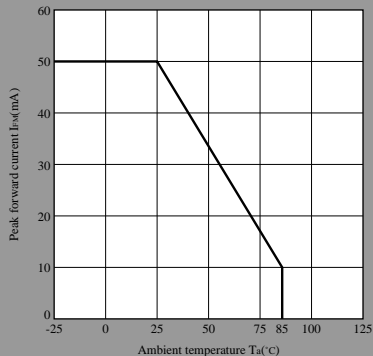

Luminous Intensity vs. Forward Current(Note)

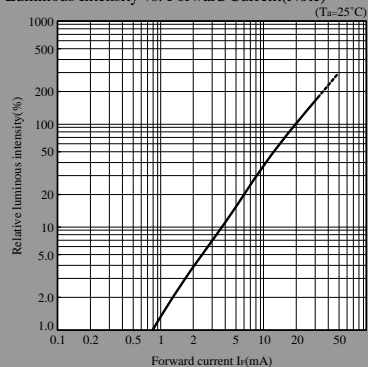

Duty Ratio vs. Peak Forward Current

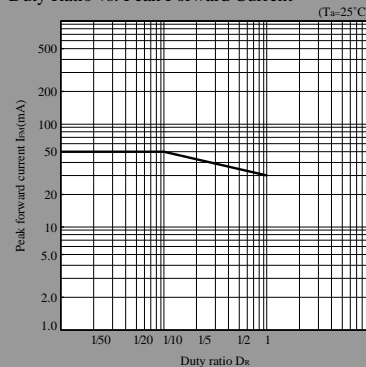

Note) Characteristics shown in diagrams are typical values. (not assurance value)