

POW-R-BLOK™
Dual SCR Isolated Module
500 Amperes / Up to 1600 Volts

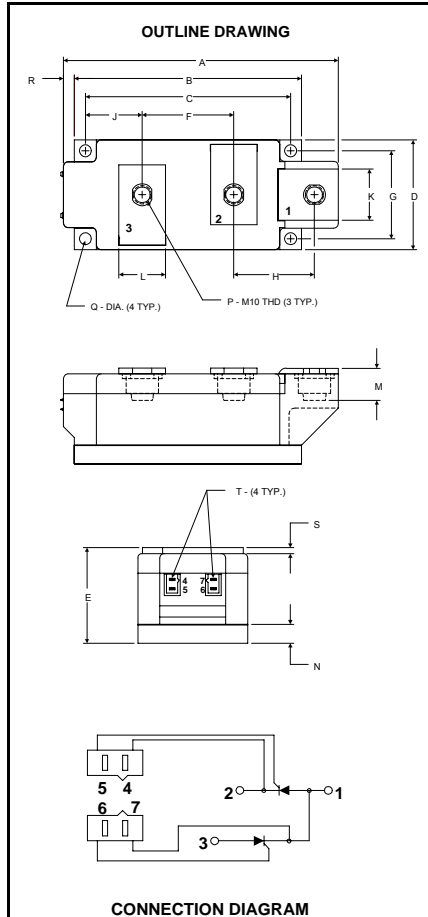

LD43__50
Dual SCR
POW-R-BLOK™ Module
500 Amperes / 800-1600 Volts

LD43 Outline Dimensions

Dimension	Inches	Millimeters
A	5.91	150.0
B	4.88	124.0
C	4.41	112.0
D	2.36	60.0
E	2.05	52.0
F	1.97	50.0
G	1.89	48.0
H	1.73	44.0
J	1.22	31.0
K	1.10	28.0
L	1.00	25.4
M	0.69	17.5
N	0.39	10.0
P	M10 Metric	M10
Q	0.26 Dia.	6.5 Dia.
R	0.24	6.0
S	0.12	3.0
T	.110 x .032	2.5 x 0.8

Note: Dimensions are for reference only.

Ordering Information:

Select the complete eight-digit module part number from the table below.

Example: LD431650 is a 1600V, 500 Ampere Dual SCR Isolated POW-R-BLOK™ Module.

Type	Voltage Volts (x100)	Current Amperes (x10)
LD43	08	50
	10	
	12	
	14	
	16	

Description:

Powerex Dual SCR Modules are designed for use in applications requiring phase control and isolated packaging. The modules are isolated for easy mounting with other components on a common heatsink. POW-R-BLOK™ has been tested and recognized by the Underwriters Laboratories.

Features:

- Electrically Isolated Heatsinking
- Aluminum Nitride Isolator
- Compression Bonded Elements
- Metal Baseplate
- Low Thermal Impedance for Improved Current Capability
- UL Recognized

Benefits:

- No Additional Insulation Components Required
- Easy Installation
- No Clamping Components Required
- Reduce Engineering Time

Applications:

- Bridge Circuits
- AC & DC Motor Drives
- Battery Supplies
- Power Supplies
- Large IGBT Circuit Front Ends

Absolute Maximum Ratings

Characteristics	Conditions	Symbol	Units
Repetitive Peak Forward and Reverse Blocking Voltage		V_{DRM} & V_{RRM}	up to 1600 V
Non-Repetitive Peak Blocking Voltage ($t < 5$ msec)		V_{RSM}	$V_{RRM} + 100$ V
RMS Forward Current		$I_{T(RMS)}$	900 A
Average Forward Current	180° Conduction, $T_C=86^\circ\text{C}$	$I_{T(AV)}$	500 A
Peak One Cycle Surge Current, Non-Repetitive	60 Hz, 100% V_{RRM} reapplied	I_{TSM}	17,000 A
	50 Hz, 100% V_{RRM} reapplied	I_{TSM}	16,300 A
Peak Three Cycle Surge Current, Non-Repetitive	60 Hz, 100% V_{RRM} reapplied	I_{TSM}	12,250 A
Peak Ten Cycle Surge Current, Non-Repetitive	60 Hz, 100% V_{RRM} reapplied	I_{TSM}	10,500 A
I^2t for Fusing for One Cycle	8.3 milliseconds	I^2t	1.20×10^6 A ² sec
	10 milliseconds	I^2t	1.33×10^6 A ² sec
Maximum Rate-of-Rise of On-State Current, (Repetitive)	Per JEDEC Standard 397 5.2.2.6	di/dt	200 A/ μ s
Operating Temperature		T_J	-40 to +130 °C
Storage Temperature		T_{stg}	-40 to +150 °C
Max. Mounting Torque, M6 Mounting Screw			55 in. – Lb.
			6 Nm
Max. Mounting Torque, M10 Terminal Screw			110 in. – Lb.
			12 Nm
Module Weight, Typical			1500 g
			3.30 lb
V Isolation @ 25C		V_{rms}	3000 V

Electrical Characteristics, T_J=25°C unless otherwise specified

Characteristics	Symbol	Test Conditions	Min.	Max.	Units
Repetitive Peak Forward Leakage Current	I _{DRM}	Up to 1600V, T _J =130°C		80	mA
Repetitive Peak Reverse Leakage Current	I _{RRM}	Up to 1600V, T _J =130°C		80	mA
Peak On-State Voltage	V _{FM}	I _{TM} =1500A		1.30	V
Threshold Voltage, Low-level	V _{(TO)1}	T _J = 130°C, I = 15%I _{T(AV)} to πI _{T(AV)}		0.81	V
Slope Resistance, Low-level	r _{T1}			0.32	mΩ
Threshold Voltage, High-level	V _{(TO)2}	T _J = 130°C, I = πI _{T(AV)} to I _{TSM}		0.90	V
Slope Resistance, High-level	r _{T2}			0.26	mΩ
V _{TM} Coefficients, Full Range		T _J = 130°C, I = 10A to 6kA V _{TM} = A + B Ln I + C I + D Sqrt I	A = B = C = D =	0.8824 -4.46E-02 8.12E-05 1.54E-02	
Minimum dV/dt	dV/dt	Exponential to V _{DRM} T _J =130°C, Gate Open	1000 Typ.		V/μs
Gate Trigger Current	I _{GT}	T _J =25°C, V _D =12V		200	mA
Gate Trigger Voltage	V _{GT}	T _J =25°C, V _D =12V		3.0	Volts
Non-Triggering Gate Voltage	V _{GDM}	T _J =130°C, V _D = ½ V _{DRM}		0.25	Volts
Peak Forward Gate Current	I _{GTM}			4.0	Amp
Peak Reverse Gate Voltage	V _{GRM}			5	Volts

Thermal Characteristics

Characteristics	Symbol		Max.	Units
Thermal Resistance, Junction to Case	R _{θJ-C}	Per Module, both conducting Per Junction, both conducting	0.0325 0.0650	°C/W °C/W
Thermal Impedance Coefficients	Z _{θJ-C}	Z _{θJ-C} = K ₁ (1-exp(-t/τ ₁)) + K ₂ (1-exp(-t/τ ₂)) + K ₃ (1-exp(-t/τ ₃)) + K ₄ (1-exp(-t/τ ₄))	K ₁ = 8.03E-04 K ₂ = 1.03E-02 K ₃ = 1.64E-02 K ₄ = 3.75E-02	τ ₁ = 3.39E-04 τ ₂ = 3.15E-03 τ ₃ = 0.106 τ ₄ = 2.066
Thermal Resistance, Case to Sink Lubricated	R _{θC-S}	Per Module	0.01	°C/W

Maximum On-State Forward Voltage Drop
 (T_j = 130 °C)

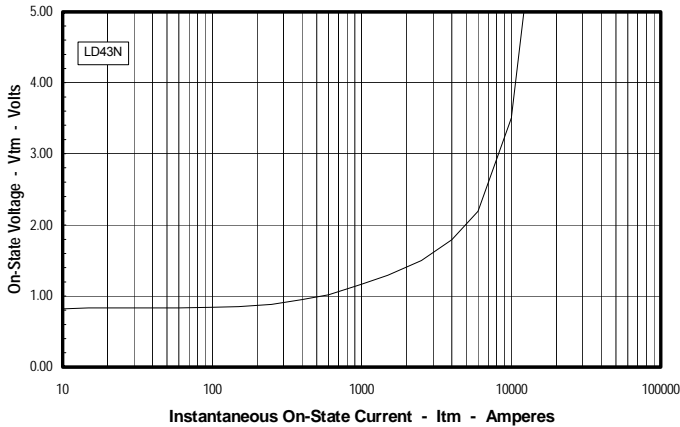

Maximum Transient Thermal Impedance
 (Junction to Case)

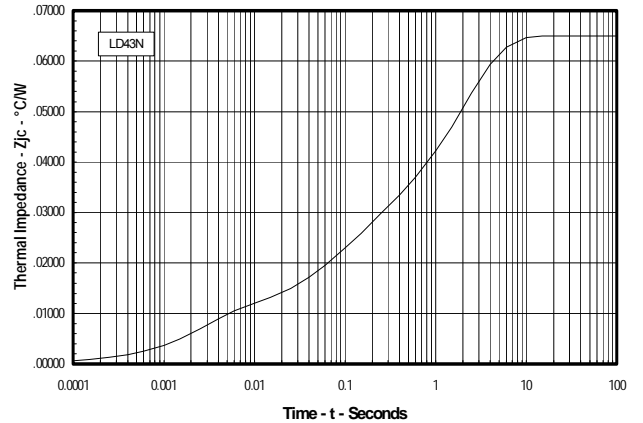

Maximum On-State Power Dissipation
 (Sinusoidal Waveform)

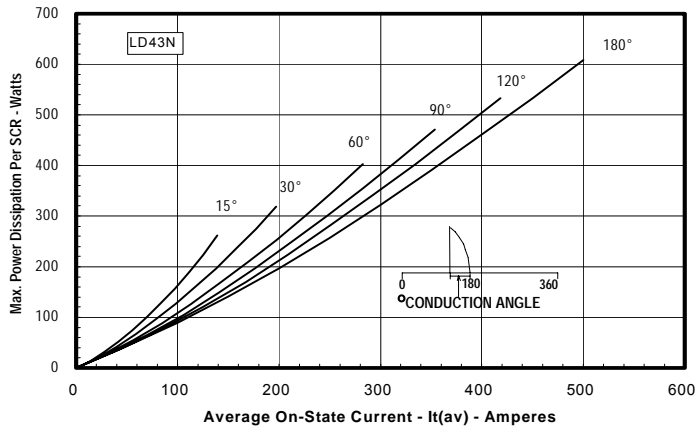

Maximum Allowable Case Temperature
 (Sinusoidal Waveform)

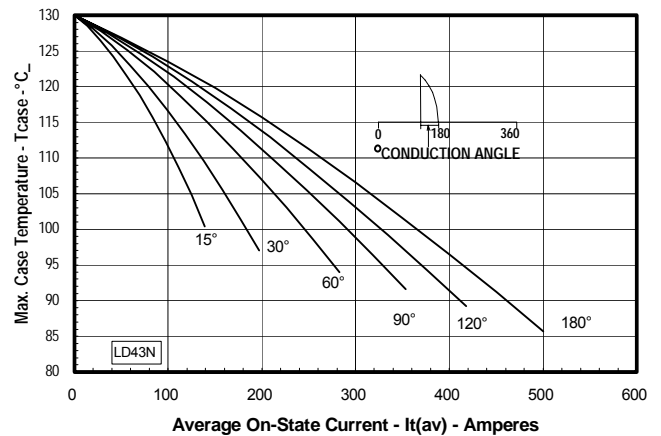

Maximum On-State Power Dissipation
 (Rectangular Waveform)

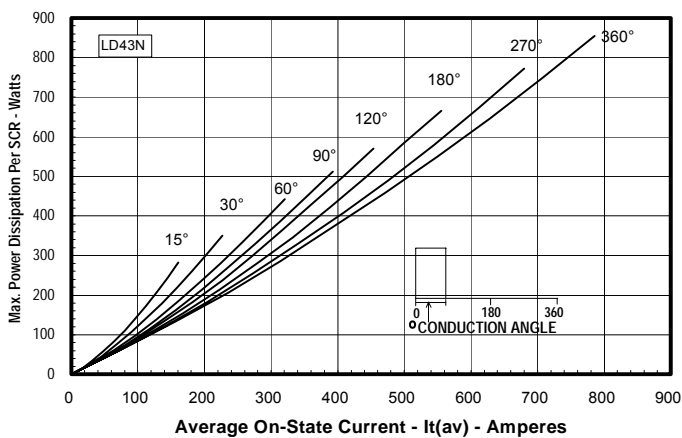

Maximum Allowable Case Temperature
 (Rectangular Waveform)

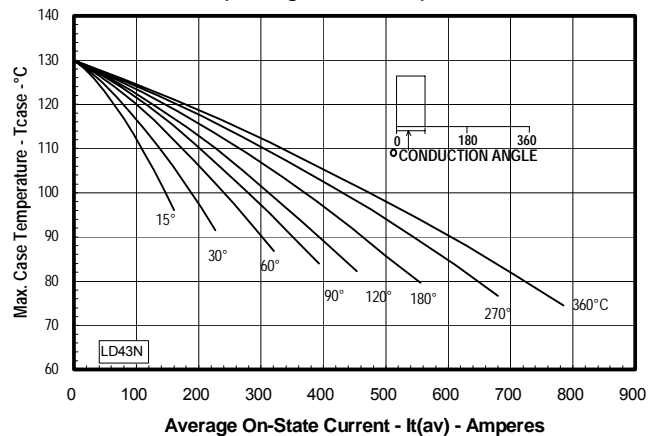

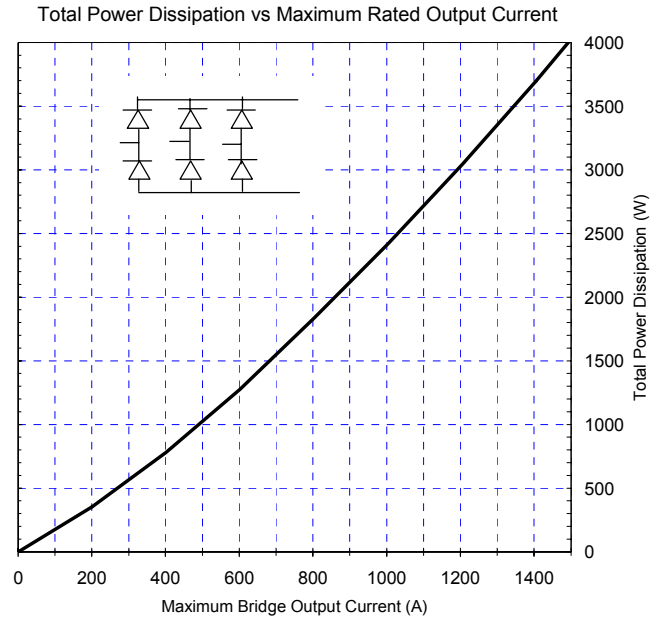
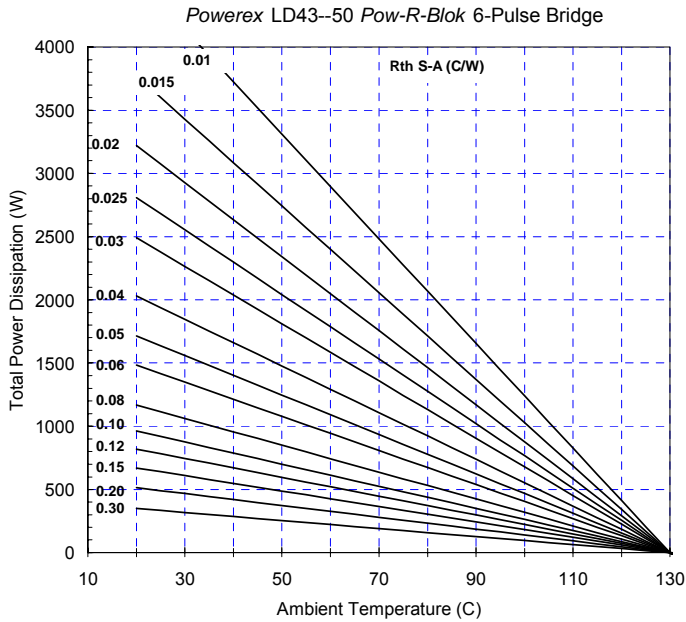

Six-Pulse Bridge Circuit Total Power Dissipation & Maximum Rated Output Current With Sink to Ambient Resistance of Heatsink as a Parameter.