

SANYO

No. ※5399

LC361000AMLL, ATLL, ARLL-70X/10X**1 MEG (131072 words × 8 bits) SRAM**

Preliminary

Overview

The LC361000AMLL, ATLL, and ARLL are 131072 words × 8 bits asynchronous silicon gate CMOS static RAMs. These SRAMs have two chip enable pins ($\overline{CE1}$ and $\overline{CE2}$) for controlling the device selected/unselected state and one output enable pin (\overline{OE}) for output control and feature high speed, low power, and wide temperature range. This makes these SRAMs optimal for systems that require high speed, low power, and battery backup, and they furthermore allow easy expansion of memory capacity.

Features

- Access time
 - 70 ns (max.): LC361000AMLL, ATLL, ARLL-70X
 - 100 ns (max.): LC361000AMLL, ATLL, ARLL-10X
- Low current drain
 - During standby
 - 2.0 μA (max.)/ $T_a = 25^\circ\text{C}$
 - 4.0 μA (max.)/ $T_a = -20$ to $+40^\circ\text{C}$
 - 20.0 μA (max.)/ $T_a = -20$ to $+70^\circ\text{C}$
 - 40.0 μA (max.)/ $T_a = -20$ to $+85^\circ\text{C}$
 - During data retention
 - 1.2 μA (max.)/ $T_a = 25^\circ\text{C}$
 - 2.4 μA (max.)/ $T_a = -20$ to $+40^\circ\text{C}$
 - 12.0 μA (max.)/ $T_a = -20$ to $+70^\circ\text{C}$
 - 24.0 μA (max.)/ $T_a = -20$ to $+85^\circ\text{C}$
 - During operation (DC)
 - 15 mA (max.)
- Single 5 V power supply: 5 V $\pm 10\%$
- Wide range of operating temperature: -20 to 85°C
- Data retention supply voltage: 2.0 to 5.5 V
- No clock required (Fully static memory)
- All input/output levels are TTL compatible
- Common input/output pins, with three output states
- Package
 - SOP 32-pin (525 mil) plastic package:
LC361000AMLL
 - TSOP 32-pin (8 mm × 20 mm) plastic package, normal:
LC361000ATLL
 - TSOP 32-pin (8 mm × 20 mm) plastic package, reversed:
LC361000ARLL

Package Dimensions

unit: mm

3205-SOP32

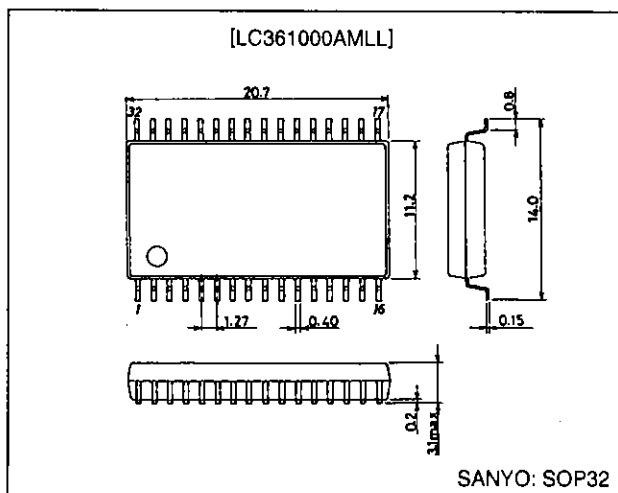

unit: mm

3224-TSOP32

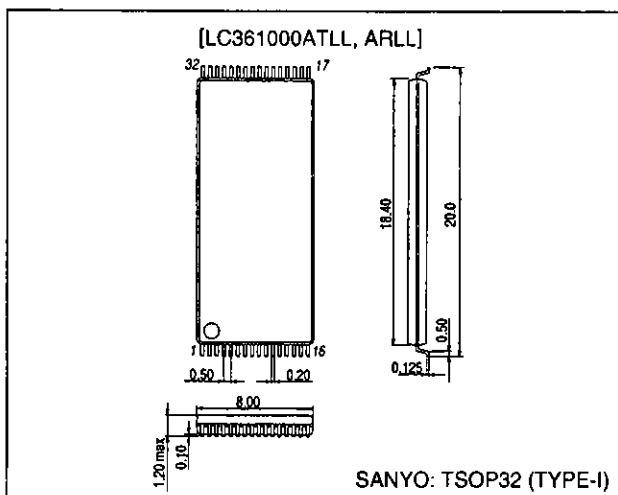

LC361000AMLL, ATLL, ARLL-70X/10X

Pin Assignments

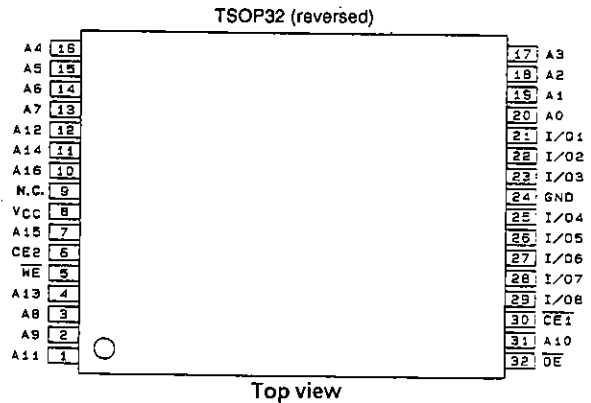
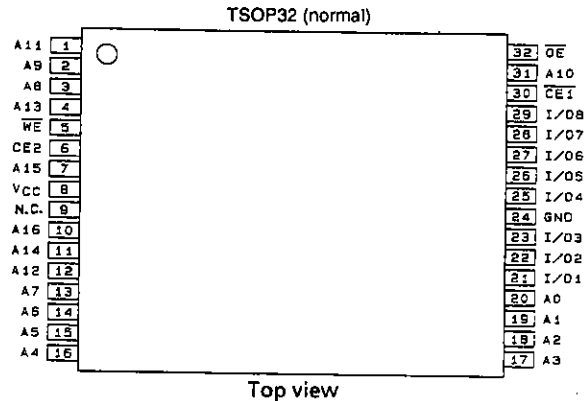
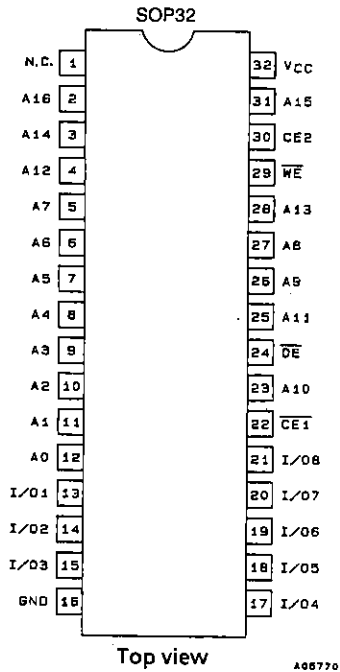

Block Diagram

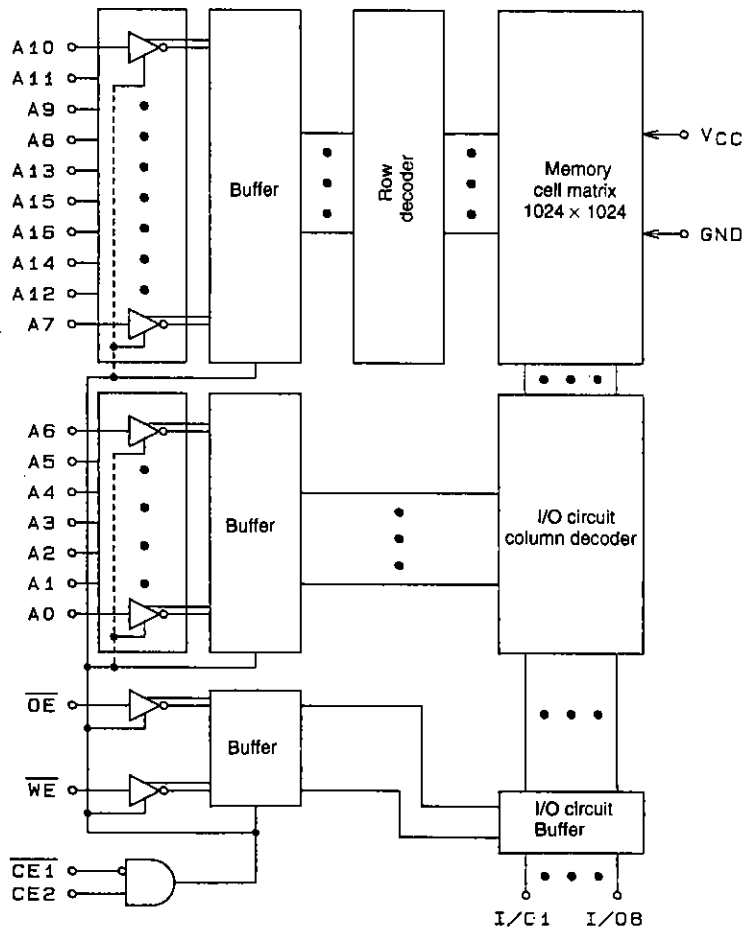

LC361000AMLL, ATLL, ARL-70X/10X

Pin Functions

A0 to A16	Address inputs
\overline{WE}	Read/write control Input
\overline{OE}	Output enable input
CE1, CE2	Chip enable input
I/O1 to I/O8	Data Input/output
V _{CC} , GND	Power supply pins

Function Logic

Mode	CE1	CE2	\overline{OE}	\overline{WE}	I/O	Supply current
Read cycle	L	H	L	H	Data output	I _{CCA}
Write cycle	L	H	X	L	Data input	I _{CCA}
Output disable	L	H	H	H	High impedance	I _{CCA}
Nonselect	H	X	X	X	High impedance	I _{CCS}
	X	L	X	X	High impedance	I _{CCS}

X: H or L

Specifications

Absolute Maximum Ratings at Ta = 25°C

Parameter	Symbol	Ratings	Unit
Maximum supply voltage	V _{CC max}	7.0	V
Input pin voltage	V _{IN}	-0.5* to V _{CC} +0.5	V
I/O pin voltage	V _{I/O}	-0.5* to V _{CC} +0.5	V
Allowable power dissipation	Pd max	0.7	W
Operating temperature	T _{opr}	-20 to +85	°C
Storage temperature	T _{stg}	-55 to +150	°C

Note: * -3.0 V when pulse width is less than 50 ns.

Stresses greater than the above listed maximum values may result in damage to the device.

DC Recommended Operating Ranges at Ta = -20 to +85°C

Parameter	Symbol	min	typ	max	Unit
Power supply voltage	V _{CC}	4.5	5.0	5.5	V
Input high level voltage	V _{IH}	2.2		V _{CC} +0.3	V
Input low level voltage	V _{IL}	-0.3*		+0.8	V

Note: * -3.0 V when pulse width is less than 50 ns.

LC361000AMLL, ATLL, ARLL-70X/10X

DC Electrical Characteristics at Ta = -20 to +85°C

Parameter	Symbol	Conditions	min	typ*	max	Unit
Operating supply current (DC)	I _{CCA1}	$V_{CE1} \leq 0.2 \text{ V}$, $V_{CE2} \geq V_{CC} - 0.2 \text{ V}$, $V_{IN} \leq 0.2 \text{ V}$ or $V_{IN} \geq V_{CC} - 0.2 \text{ V}$, $I_{I/O} = 0 \text{ mA}$			10	mA
	I _{CCA2}	$V_{CE1} = V_{IL}$, $V_{CE2} = V_{IH}$, $V_{IN} = V_{IH}$ or V_{IL} , $I_{I/O} = 0 \text{ mA}$		7	15	mA
Average operating supply current	I _{CCA3}	$V_{CE1} = V_{IL}$, $V_{CE2} = V_{IH}$, $I_{I/O} = 0 \text{ mA}$, min cycle	70 ns	40	80	mA
			100 ns	35	60	
Standby supply current	I _{CCS1}	$(V_{CE2} \leq 0.2 \text{ V})$ or $(V_{CE1} \geq V_{CC} - 0.2 \text{ V}, V_{CE2} \geq V_{CC} - 0.2 \text{ V}$ or $V_{CE2} \leq 0.2 \text{ V})$	-20 to +85°C		40	μA
			-20 to +70°C		20	
			-20 to +40°C		4	
			25°C	0.7	2	
	I _{CCS2}	$V_{CE2} = V_{IL}$ or $V_{CE1} = V_{IH}$		0.6	3	mA
Input leakage current	I _{LI}	$V_{IN} = 0$ to V_{CC}	-1		+1	μA
I/O leakage current	I _{LO}	$V_{CE1} = V_{IH}$ or $V_{CE2} = V_{IL}$ or $V_{OE} = V_{IH}$ or $V_{WE} = V_{IL}$, $I_{I/O} = 0$ to V_{CC}	-1		+1	μA
Output high level voltage	V _{OH}	I _{OH} = -1.0 mA	2.4			V
Output low level voltage	V _{OL}	I _{OL} = 2.1 mA			0.4	V

Note: * Reference value at V_{CC} = 5 V, Ta = 25°C.

Input/Output Capacitances at Ta = 25°C, f = 1 MHz

Parameter	Symbol	Conditions	min	typ	max	Unit
Input capacitance	C _{IN}	V _{IN} = 0 V			7	pF
Input/output capacitance	C _{I/O}	V _{I/O} = 0 V			8	pF

Note: These parameters were obtained through sampling, and not full-lot measurement.

AC Electrical Characteristics at Ta = -20 to +85°C, V_{CC} = 5 V ±10%

AC Test Conditions

Parameter	Conditions
Input pulse voltage level	0.6 V, 2.4 V
Input rise and fall time	5 ns
Input and output timing level	1.5 V
Output load	1 TTL gate + C _L = 100 pF (70 ns/100 ns) (including scope and jig capacitances)

LC361000AMLL, ATLL, ARL-70X/10X

Read Cycle

Parameter	Symbol	LC361000AMLL, ATLL, ARL				Unit
		-70X		-10X		
		min	max	min	max	
Read cycle time	t_{RC}	70		100		ns
Address access time	t_{AA}		70		100	ns
$\overline{CE1}$ access time	t_{CA1}		70		100	ns
CE2 access time	t_{CA2}		70		100	ns
\overline{OE} access time	t_{OA}		40		50	ns
Output hold time	t_{OH}	10		10		ns
$\overline{CE1}$ output enable time	t_{COE1}	10		10		ns
CE2 output enable time	t_{COE2}	10		10		ns
\overline{OE} output enable time	t_{OOE}	5		5		ns
$\overline{CE1}$ output disable time	t_{COD1}		25		35	ns
CE2 output disable time	t_{COD2}		25		35	ns
\overline{OE} output disable time	t_{OOD}		25		35	ns

Write Cycle

Parameter	Symbol	LC361000AMLL, ATLL, ARL				Unit
		-70X		-10X		
		min	max	min	max	
Write cycle time	t_{WC}	70		100		ns
Address valid to end of write	t_{AW}	60		70		ns
Address setup time	t_{AS}	0		0		ns
Write pulse width	t_{WP}	50		70		ns
$\overline{CE1}$ setup time	t_{CW1}	60		70		ns
CE2 setup time	t_{CW2}	60		70		ns
Write recovery time	t_{WR}	5		5		ns
$\overline{CE1}$ write recovery time	t_{WR1}	0		0		ns
CE2 write recovery time	t_{WR2}	0		0		ns
Data setup time	t_{DS}	30		40		ns
Data hold time	t_{DH}	0		0		ns
$\overline{CE1}$ data hold time	t_{DH1}	0		0		ns
CE2 data hold time	t_{DH2}	0		0		ns
\overline{WE} output enable time	t_{WOE}	10		10		ns
\overline{WE} output disable time	t_{WOD}		25		30	ns

Timing Chart

Read Cycle (1): $\overline{CE1} = \overline{OE} = V_{IL}$, $CE2 = V_{IH}$, $\overline{WE} = V_{IH}$

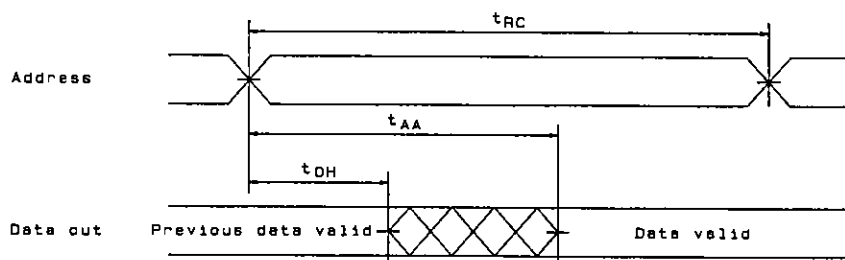

A05774

Write Cycle (2): $\overline{CE1}$ control (Note 6)

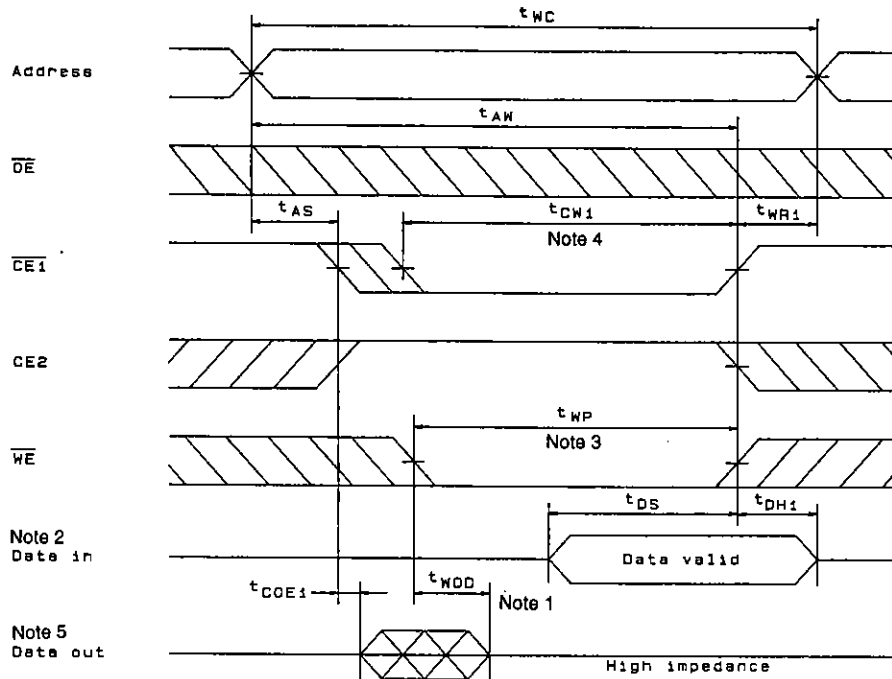

Write Cycle (3): $\overline{CE2}$ control (Note 6)

A05777

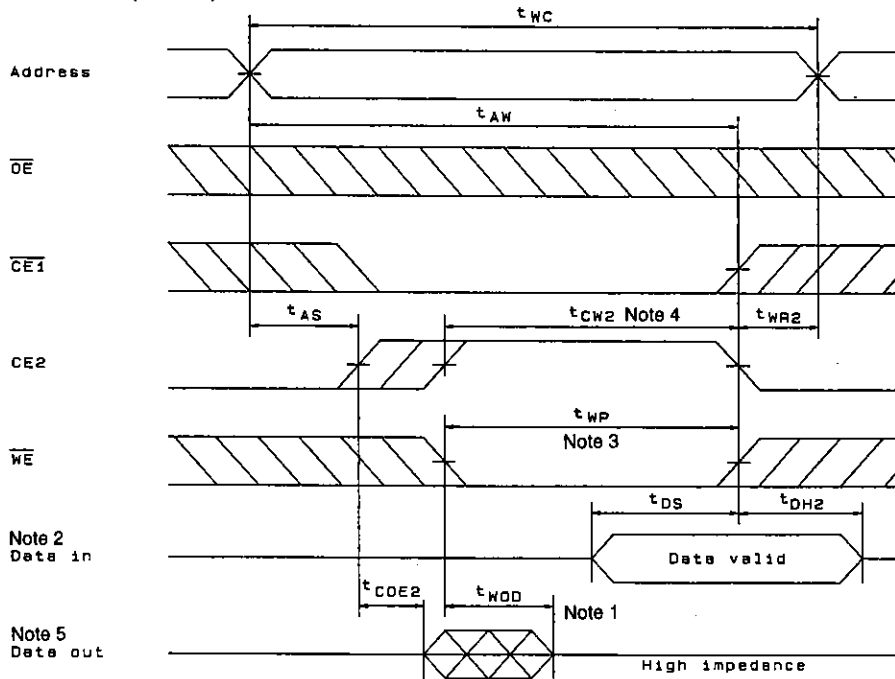

A05778

- Note: 1. t_{COD1} , t_{COD2} , t_{OOD} , and t_{WOD} are stipulated as the times until the outputs reach the high-impedance state, and are not determined by the output voltage levels.
2. Reverse phase signals must not be applied externally when the data outputs are in the output state.
3. t_{WP} is defined as the period when $\overline{CE1}$ and \overline{WE} are low and $\overline{CE2}$ is high, from the falling edge of \overline{WE} until either a rising edge of $\overline{CE1}$ or \overline{WE} or a falling edge of $\overline{CE2}$, whichever of these happens first.
4. t_{WC1} and t_{WC2} are defined as the periods when $\overline{CE1}$ and \overline{WE} are low and $\overline{CE2}$ is high, from either a falling edge of $\overline{CE1}$ or a rising edge of $\overline{CE2}$, until a rising edge of $\overline{CE1}$ or \overline{WE} , or a falling edge of $\overline{CE2}$, whichever happens first.
5. The data outputs will be in the high-impedance state if either \overline{OE} is high, $\overline{CE1}$ is high, $\overline{CE2}$ is low, or \overline{WE} is low.
6. If \overline{OE} goes high during a write cycle, the data outputs will go to the high-impedance state.

LC361000AMLL, ATLL, ARL-70X/10X

Data Retention Characteristics at Ta = -20 to +85°C

Parameter	Symbol	Conditions	min	typ*	max	Unit
Data retention supply voltage	V _{DR1}	V _{CE1} ≥ V _{CC} - 0.2 V, V _{CE2} ≥ V _{CC} - 0.2 V, or V _{CE2} ≤ 0.2 V	2.0		5.5	V
	V _{DR2}	V _{CE2} ≤ 0.2 V	2.0		5.5	V
Data retention supply current	I _{CCDR1}	V _{CC} = 3.0 V, V _{CE1} ≥ V _{CC} - 0.2 V, V _{CE2} ≥ V _{CC} - 0.2 V, or V _{CE2} ≤ 0.2 V	-20 to +85°C		24	μA
			-20 to +70°C		12	
			-20 to +40°C		2.4	
			25°C	0.4	1.2	
	I _{CCDR2}	V _{CC} = 3.0 V, V _{CE2} ≤ 0.2 V	-20 to +85°C		24	μA
			-20 to +70°C		12	
			-20 to +40°C		2.4	
			25°C	0.4	1.2	
Chip enable setup time	t _{CDR}		0			ns
Chip enable hold time	t _R		5			ms

Note: * Reference value at Ta = 25°C.

Data Retention Waveforms (1): (CE1 control)

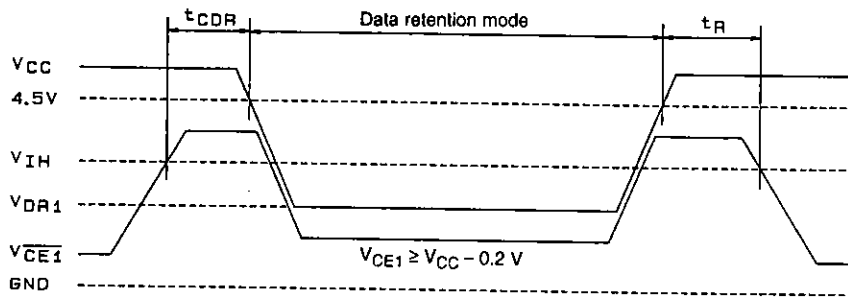

Data Retention Waveforms (2): (CE2 control)

A05779

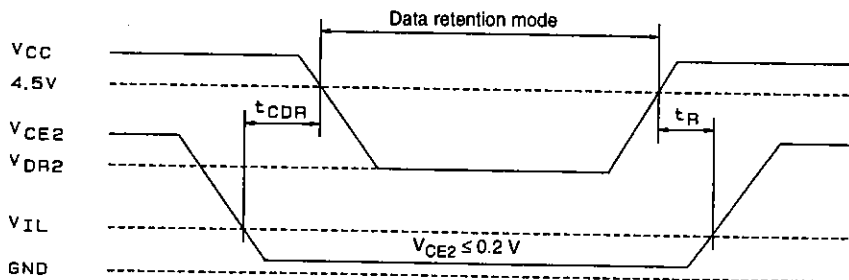

A05780

- No products described or contained herein are intended for use in surgical implants, life-support systems, aerospace equipment, nuclear power control systems, vehicles, disaster/crime-prevention equipment and the like, the failure of which may directly or indirectly cause injury, death or property loss.
- Anyone purchasing any products described or contained herein for an above-mentioned use shall:
 - ① Accept full responsibility and indemnify and defend SANYO ELECTRIC CO., LTD., its affiliates, subsidiaries and distributors and all their officers and employees, jointly and severally, against any and all claims and litigation and all damages, cost and expenses associated with such use;
 - ② Not impose any responsibility for any fault or negligence which may be cited in any such claim or litigation on SANYO ELECTRIC CO., LTD., its affiliates, subsidiaries and distributors or any of their officers and employees jointly or severally.
- Information (including circuit diagrams and circuit parameters) herein is for example only; it is not guaranteed for volume production. SANYO believes information herein is accurate and reliable, but no guarantees are made or implied regarding its use or any infringements of intellectual property rights or other rights of third parties.

This catalog provides information as of September, 1996. Specifications and information herein are subject to change without notice.