



LA8638NV

Low-Voltage Componder IC for Cordless Telephones

Overview

The LA8638NV provides dynamic range expansion, noise suppression for enhancing the quality of audio signals in cordless telephones and other communications systems. This single chip provides the functions that make it ideal for cordless telephones: a compressor with a logarithmic compression ratio of 1/2, expander with a logarithmic expansion ratio of 2, splatter filter, microphone amplifier, BTL amplifier, waveform shaper for the receiving signal, muting for both receiving and transmitting signals, and standby operation.

Functions

- Transmitter circuits: compressor, microphone amplifier, limiter (IDC), muting, output level changes to user-specified levels, and splatter filter
- Receiver circuits: expander, buffer amplifier for filters, muting, output level changes to user-specified levels, and BTL amplifier
- Other circuits: waveform shaper for the receiving signal and standby operation

Features

- Full processing of baseband signals for both receiving and transmitting signals
- Built-in BTL receiver amplifier for driving a ceramic

speaker with a load of 2 k Ω

- Standby operation that conserves battery power during intermittent reception by disabling all but the waveform shaper for the receiving signal
- Built-in splatter filter with user-specified f_c
- Low-voltage operation (1.8 V to 5.5 V)

Package Dimensions

unit: mm

3191A-SSOP30

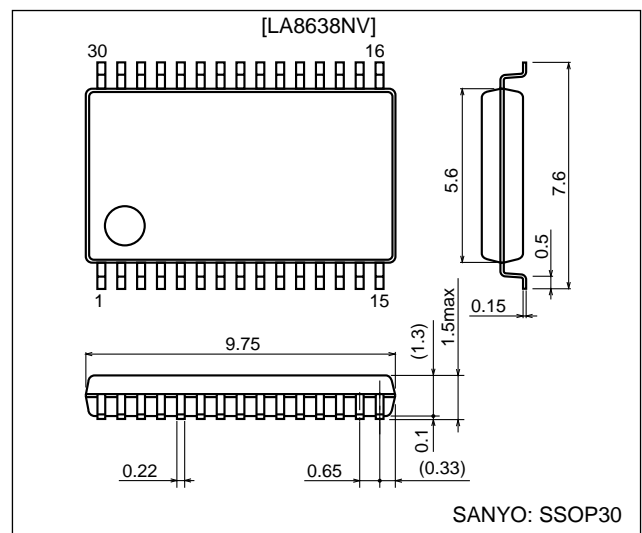

Specifications

Maximum Ratings at $T_a = 25^\circ\text{C}$

Parameter	Symbol	Conditions	Ratings	Unit
Maximum power supply voltage	$V_{CC \text{ max}}$		7.0	V
Maximum power dissipation	$P_d \text{ max}$	$T_a \leq 75^\circ\text{C}$	100	mW
Operating temperature	T_{opr}		-20 to +75	$^\circ\text{C}$
Storage temperature	T_{stg}		-40 to +125	$^\circ\text{C}$

■ Any and all SANYO products described or contained herein do not have specifications that can handle applications that require extremely high levels of reliability, such as life-support systems, aircraft's control systems, or other applications whose failure can be reasonably expected to result in serious physical and/or material damage. Consult with your SANYO representative nearest you before using any SANYO products described or contained herein in such applications.

■ SANYO assumes no responsibility for equipment failures that result from using products at values that exceed, even momentarily, rated values (such as maximum ratings, operating condition ranges, or other parameters) listed in products specifications of any and all SANYO products described or contained herein.

SANYO Electric Co., Ltd. Semiconductor Company

TOKYO OFFICE Tokyo Bldg., 1-10, 1 Chome, Ueno, Taito-ku, TOKYO, 110-8534 JAPAN

LA8638NV

Operating Conditions at $T_a = 25^\circ\text{C}$

Parameter	Symbol	Conditions	Ratings	Unit
Recommended power supply voltage	V_{CC}		2.4	V
Operating power supply voltage range	V_{CCop}		1.8 to 5.5	V

Electrical Characteristics at $T_a = 25^\circ\text{C}$, $V_{CC} = 2.4\text{ V}$, $f_{IN} = 1\text{ kHz}$

Parameter	Symbol	Conditions	Ratings			Unit
			min	typ	max	
Current drain with no signal	I_{CCO}	No signal	3.0	5.4	7.6	mA
Standby current	I_{STBY}	Standby mode, No signal	0.4	0.76	1.0	mA
[Transmitter block] $V_{inrefc} = -60\text{ dBV} = 0\text{ dB}$, microphone amplifier gain = 40 dB, $R_L = 15\text{ k}\Omega$						
Output level	V_{OC}	$V_{IN} = V_{inrefc} = 0\text{ dB}$	-18.1	-16.1	-14.1	dBV
Gain change level	G_{CC}	$V_{IN} = -10\text{ dB}$	3.5	4.0	4.4	dB
Gain error	G_{EC}	$V_{IN} = -40\text{ dB}$	-2.0	-0.7	+1.0	dB
Total harmonic distortion	THDc	$V_{IN} = 0\text{ dB}$		0.45	1.0	%
Output noise voltage	V_{NOC}	$R_g = 620\Omega$, $f = 20\text{ to }20\text{ kHz}$		1.8	4.5	mVrms
Limiting voltage	V_{LT}	$V_{IN} = +30\text{ dB}$, 1 kHz BPF	0.88	1.05	1.23	Vp-p
Microphone amplifier maximum voltage gain	VG max		40	46		dB
Low pass filter attenuation	Latt	$f_{IN} = 5\text{ kHz}$; fifth-order Butterworth function filter ($f_c = 3.35\text{ kHz}$)	12.0	16.5	25.0	dB
Muting attenuation	ATTc	$V_{IN} = +30\text{ dB}$, 1 kHz BPF		-83	-65	dBV
Crosstalk level	CTc	$RX - V_{IN} = -10\text{ dBV}$, 1 kHz BPF		-61	-50	dBV
[Receiver block] $V_{inrefc} = -20\text{ dBV} = 0\text{ dB}$, $R_L = 15\text{ k}\Omega$						
Output level	V_{Oe}	$V_{IN} = V_{inrefc} = 0\text{ dB}$	-18.8	-16.3	-13.8	dBV
Gain change level	G_{Ce}	$V_{IN} = 0\text{ dB}$	6.0	7.1	8.4	dB
Gain error	G_{Ee}	$V_{IN} = -30\text{ dB}$	-1.5	+0.3	+2.0	dB
Output noise voltage	V_{NOe}	$R_g = 620\Omega$, $f = 20\text{ to }20\text{ kHz}$		18	40	μVrms
Muting attenuation	ATTe	$V_{IN} = +10\text{ dB}$, 1 kHz BPF		-100	-80	dBV
Crosstalk level	CTe	$TX - V_{IN} = -40\text{ dBV}$, 1 kHz BPF		-83	-65	dBV
[BTL amplifier] $R_L = 2\text{ k}\Omega$						
Maximum output voltage	V_{Obtl}	THD = 3%	3.2	4.2		Vp-p
Total harmonic distortion	THDbtl	$V_{IN} = -5\text{ dBV}$		0.4	1.0	%
[Data shaper] $V_{IN} = -20\text{ dBV}$, $R_L = 100\text{ k}\Omega$						
Duty factor	DUTY		43	50	57	%
Dead zone	UNSN		-39.0	-34.5	-30.0	dBV
Output high-level voltage	V_H		2.2	2.38		V
Output low-level voltage	V_L			0.12	0.3	V
[Digital input characteristics]						
Input high-level voltage 1	V_{IH1}	Pins 17, 18, 20, and 22	$0.6 V_{CC}$			V
Input low-level voltage 1	V_{IL2}	Pins 17, 18, 20, and 22			$0.25 V_{CC}$	V
Input high-level voltage 2	V_{IH2}	Pin 19	1.3			V
Input low-level voltage 2	V_{IL2}	Pin 19			0.3	V

Sample Application Circuit

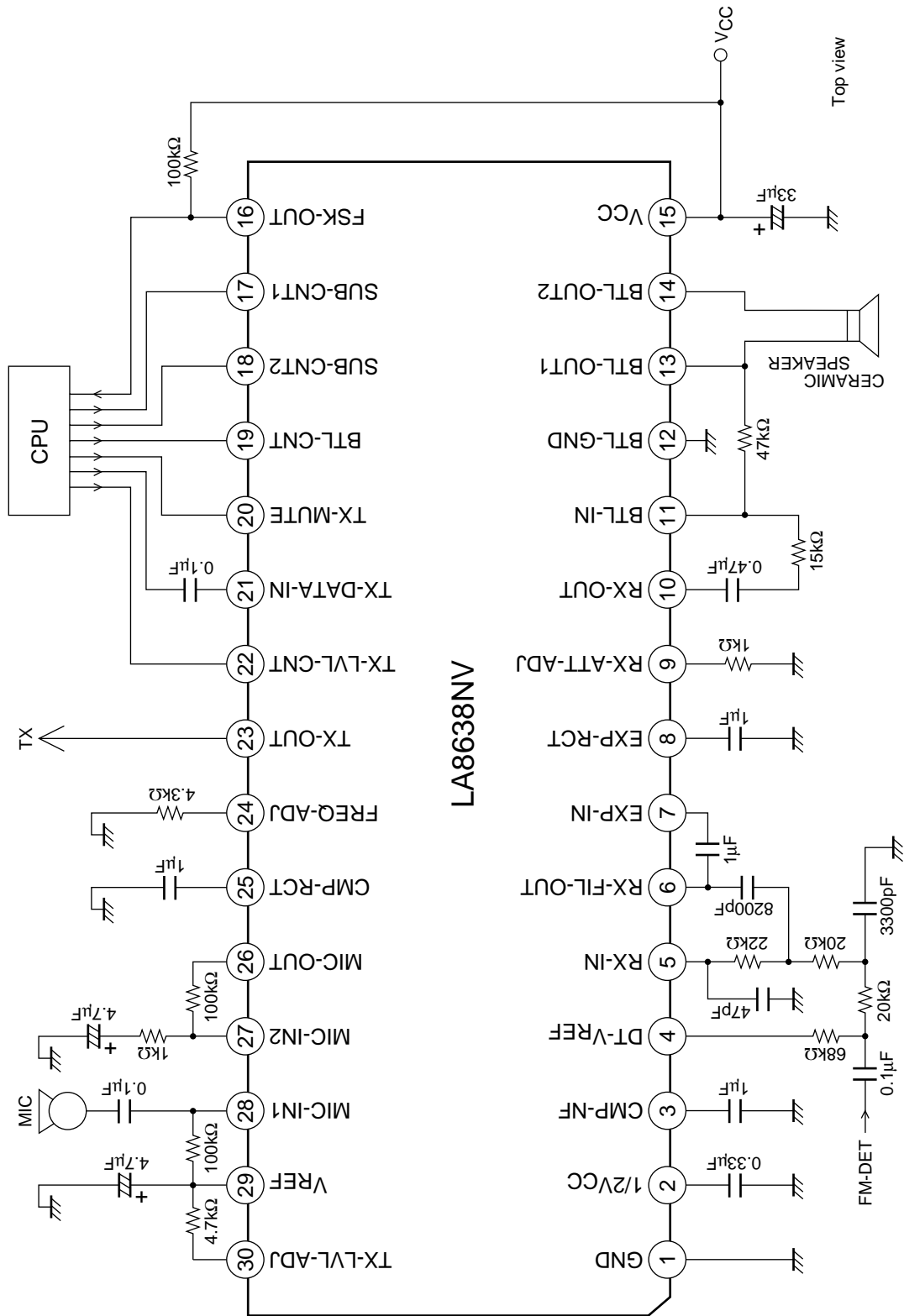

A13520

LA8638NV

Test Circuit

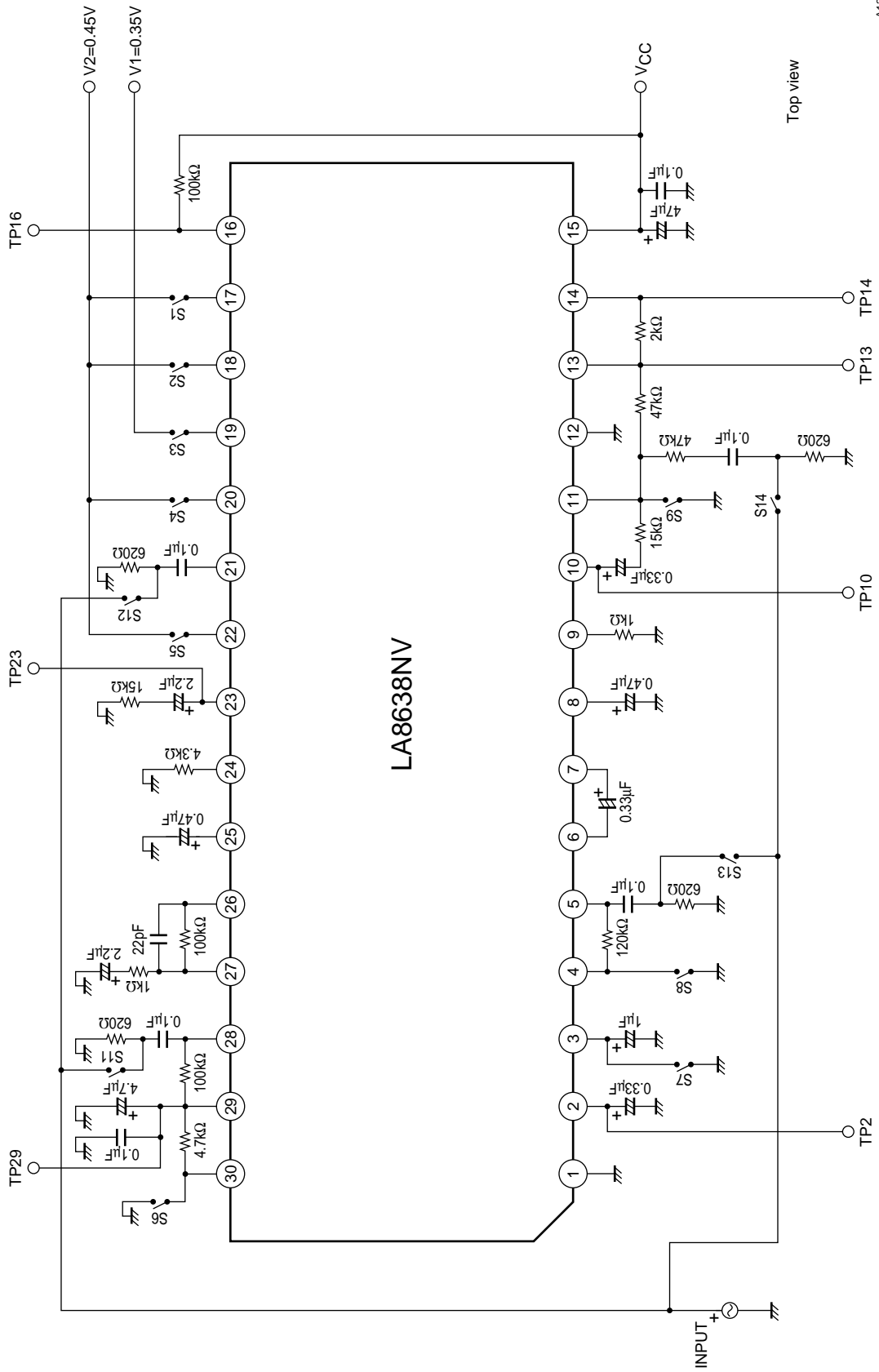

Top view

A13521

Usage Notes

1. Internal Reference Voltages

The chip uses the following reference voltages internally.

Pin 29 (V_{REF1}) Power supply voltage follower (approximately $0.5 V_{CC}$)

Pin 4 (V_{REF2}) Fixed voltage (approximately 1.25 V)

2. Microphone Amplifier

Do not use the microphone amplifier as a buffer amplifier (non-reversing, zero-gain amplifier) because it is designed for high-gain operation—that is, gains above 6 dB—and is susceptible to oscillation below that level.

For proper circuit balance, use the same resistance value for the bias resistor (between pins 28 and 29) and the feedback resistor (between pins 26 and 27).

3. BTL Amplifier

The built-in BTL amplifier is designed for ceramic speakers only. Do not use it to drive a dynamic speaker.

4. Receiver Input Filter

The receiver input filter uses external capacitors and resistors to determine the cutoff frequencies. The external circuit constants may be easily derived from the standardized circuit constants. Start by making all resistors the same size and determine the capacitances required to achieve the desired cutoff frequencies from the circuit constants in Table 1. Then, because capacitors are not available for such precise values, choose the closest ones available and then fine-tune the resistances. (As a result, the final resistances will not necessarily be equal.)

Once the filter constants have been established, choose the bias voltage supply resistor R_B so that the total DC resistance between pins 4 and 5 is on the order of 120 k Ω to standardize the voltage drop across this path due to the small base current from the transistor in the pin 5 input circuit and thus the duty factor for the data shaper at the next stage.

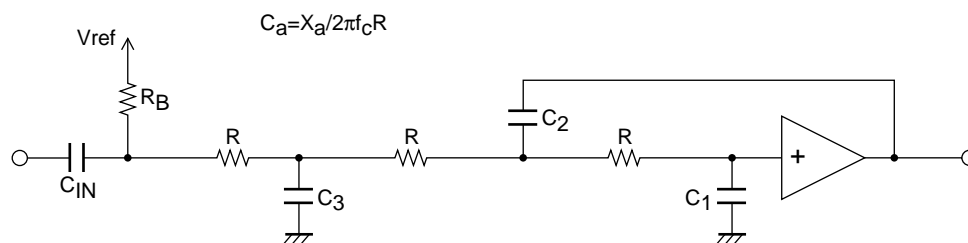

A13522

Table 1. Standardized Circuit Constants

Lowpass filter type	X1	X2	X3
Second-order Butterworth function	0.7071	1.4142	—
Third-order Butterworth function	0.2025	3.5468	1.3926
Second-order Bessel function	0.5000	0.6667	—
Third-order Bessel function	0.1451	0.8136	0.5647

The Bessel functions for cutoff frequencies do not incorporate the notion of 3-dB attenuation. The 3-dB attenuation frequency for the second-order function is 1.38 f_c ; for the third-order function, 1.75 f_c .

5. Splatter Filter Cutoff Frequency

The resistance between pin 24 and ground determines the cutoff frequency for the splatter filter in the transmitter circuit. (See Graph 1 on p. 8.) To fine-tune this frequency, use two resistors and adjust them to achieve the desired frequency.

6. Gain Change Levels

The resistance between pins 29 and 30 determines the gain change level for the transmitter circuits. (See Graph 2 on p. 8.)

The resistance between pin 9 and ground determines the gain change level for the receiver circuits. (See Graph 3 on p. 8.)

7. Protective Diodes Preventing Static Breakdown

The control pins and data output pins have had their upper protective diodes removed so as to permit direct connection to a microcomputer.

- No protective diodes: V_{CC} (pin 15), GND (pins 1 and 12)
- Lower protective diodes only: Pins 16 to 20, 22
- Both upper and lower protective diodes: All other pins

8. Preemphasis and Deemphasis

This chip provides preemphasis in the microphone amplifier and deemphasis in the BTL amplifier's input stage. The amount depends on the CR time constants for the filters on the corresponding pins—the primary high pass filter on the microphone amplifier's positive (pin 28) or negative (pin 27) input for preemphasis and the primary low pass filter between pins 10 and 11 for deemphasis.

9. Full-Wave Rectifier Smoothing Capacitors

The external capacitors on pins 8 and 25 are for the full-wave rectifiers for the expander and compressor. They not only smooth the output but also determine the time constant for the transient characteristics. This time constant is the product of the capacitance and 15 k Ω , the input resistance of the full-wave rectifier. Although there is a tendency to lower the time constant for the expander to reduce noise at the ends of words, the designer must keep in mind that such cuts reduce the amount of smoothing and thus raise the risk of distortion.

10. Compressor's Summing Amplifier

Achieving a DC gain of 1 and an AC gain of infinity from the compressor's summing amplifier requires suppressing AC feedback with the capacitor on pin 3. The cutoff frequency is determined by the product of its capacitance and the internal resistance of 22.5 k Ω .

11. Standby Function

The chip's standby function does not produce a total shutdown of all circuits. It disables the audio signal processing block, but leaves the waveform shaper block for the receiving signal operating. For this reason, it is not possible to connect the battery directly to the power supply pin (pin 15). There must be an intervening transistor switch for an intermittent power supply.

12. Control Modes

Pin 17	Pin 18	
SUB-CNT1	SUB-CNT2	Mode
OPEN/HIGH	OPEN/HIGH	Standby
OPEN/HIGH	LOW	Receiver muted
LOW	OPEN/HIGH	Normal receiver output levels
LOW	LOW	Low receiver output levels

Pin Number	Pin Name	OPEN/HIGH	LOW
Pin 19	BTL-CNT	BTL amplifier disabled	BTL amplifier enabled
Pin 20	TX-MUTE	Transmitter muted	Transmitter enabled
Pin 22	TX-LVL-CNT	Normal transmitter output levels	High transmitter output levels

Note: The standby mode overrides all other mode settings.

LA8638NV

Graph 1. Splatter Filter Cutoff Frequency vs. External Resistance

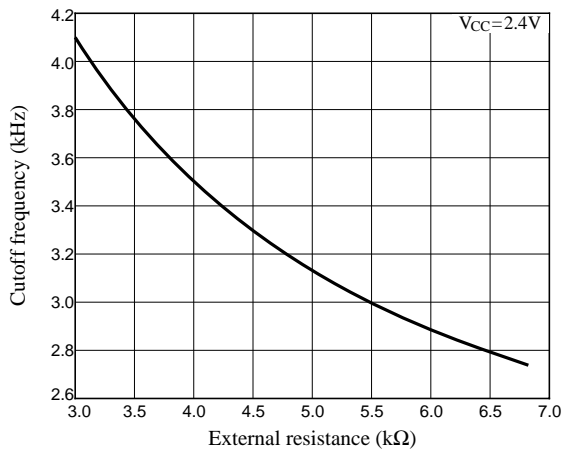

Graph 2. Transmitter Gain Change Level vs. External Resistance

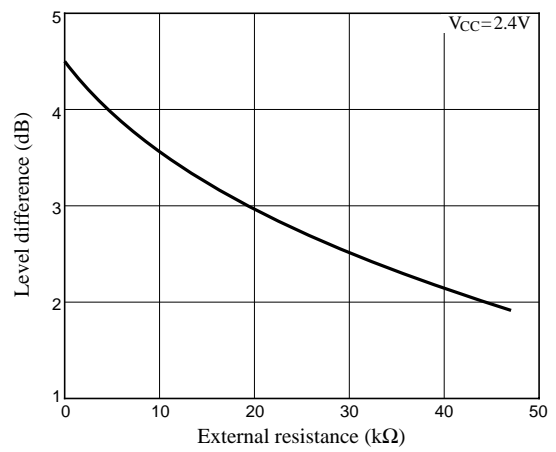

Graph 3. Receiver Gain Change Level vs. External Resistance

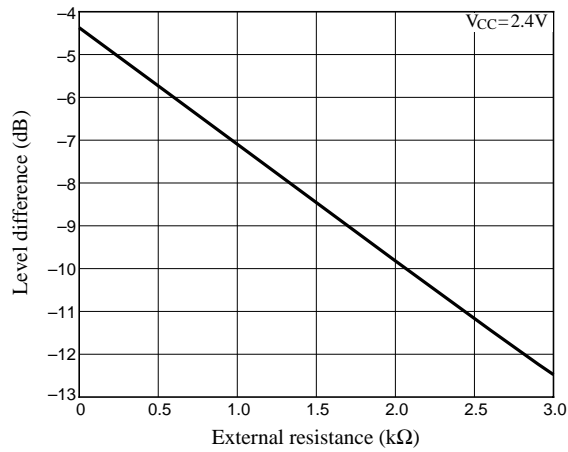

LA8638NV

Pin Descriptions

Pin Number	Pin Name	Pin Voltage	Equivalent Circuit	Description
1	GND			Ground for all circuits except BTL amplifier
2	1/2 V _{CC}	V _{CC} /2		Resistance voltage divider pin
29	V _{REF}	V _{CC} /2		Reference voltage for all circuits except receiver block
3	CMP-NF	V _{CC} /2		AC feedback control for compressor's summing amplifier DC gain: 1 AC gain: Infinite
4	DT-V _{REF}	1.25 V		Reference voltage for receiver block. This supplies the bias voltage for pin 5.
5	RX-IN	1.25 V power supply		Filter buffer input
6	RX-FIL-OUT	1.25 V		Filter buffer output
7	EXP-IN	V _{CC} /2		Expander input. Voltage-current converter input. Full-wave rectifier input.
8	EXP-RCT	Indeterminate (when there is no signal)		Full-wave rectifier output for expander block (AC smoothing)
9	RX-ATT-ADJ	0.03 V		Pin for setting attenuation for receiver output level switching
10	RX-OUT	V _{CC} /2		Receiver block output

Continued on next page.

LA8638NV

Continued from preceding page.

Pin Number	Pin Name	Pin Voltage	Equivalent Circuit	Description
12	BTL-GND			Ground for BTL amplifier
11	BTL-IN	$V_{CC}/2$		BTL amplifier input
13	BTL-OUT1	$V_{CC}/2$		BTL amplifier reversed output
14	BTL-OUT2	$V_{CC}/2$		BTL amplifier non-reversed output
15	V_{CC}			Power supply pin
16	FSK-OUT	Indeterminate (when there is no signal)		Comparator output (open collector output)
17	SUB-CNT1	V_{CC}		Internal operating mode control pins. All four pins have identical structures.
18	SUB-CNT2	V_{CC}		
20	TX-MUTE	V_{CC}		
22	TX-LVL-CNT	V_{CC}		
19	BTL-CNT	$\frac{V_{CC} + 0.65}{2}$		BTL amplifier operation control pins
21	TX-DATA-IN	$V_{CC} / 1.6$		Transmitter data input
23	TX-OUT	$V_{CC} / 1.6$		Transmitter output
24	FREQ-ADJ	0.01 V		Pin for setting cutoff frequency of splatter filter

Continued on next page.

LA8638NV

Continued from preceding page.

Pin Number	Pin Name	Pin Voltage	Equivalent Circuit	Description
25	CMP-RCT	Indeterminate (when there is no signal)		Full-wave rectifier output for compressor block (AC smoothing)
26	MIC-OUT	$V_{CC}/2$		Microphone amplifier output
27	MIC-IN2	$V_{CC}/2$		Microphone amplifier negative input
28	MIC-IN1	$V_{CC}/2$ power supply		Microphone amplifier positive input
30	TX-LVL-ADj	$V_{CC}/2$		Pin for setting amplification for transmitter output level switching

I/O Characteristics

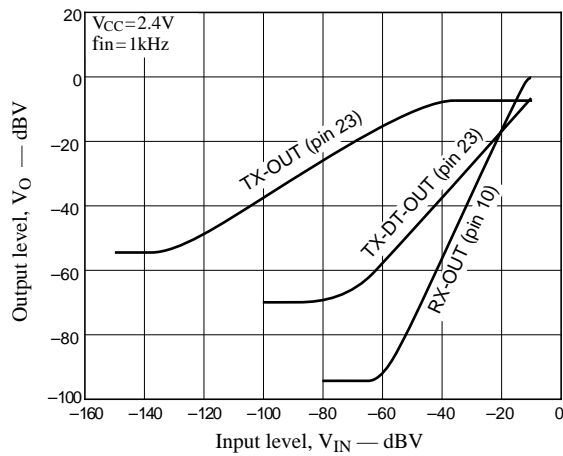

Crosstalk Characteristics

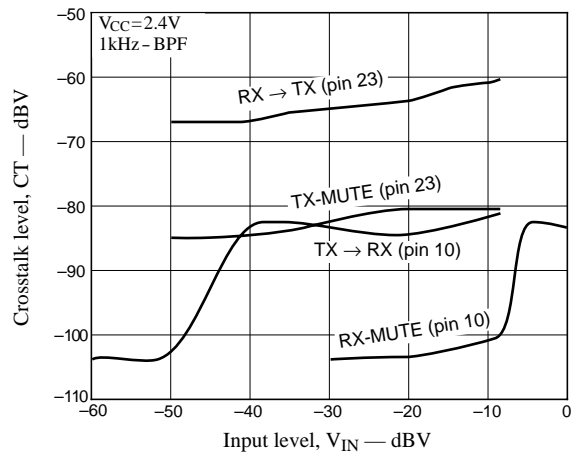

Splatter Filter Frequency Characteristics

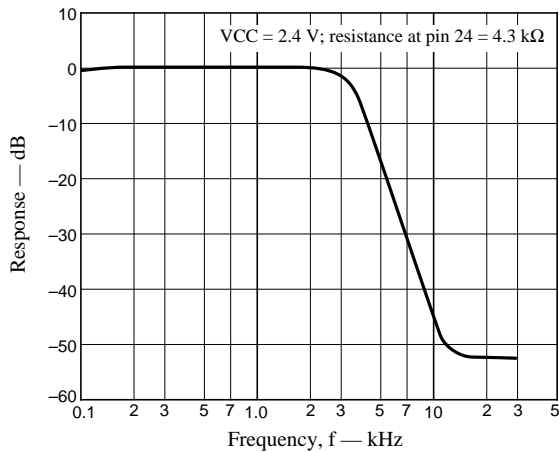

Current Drain — V_{CC}

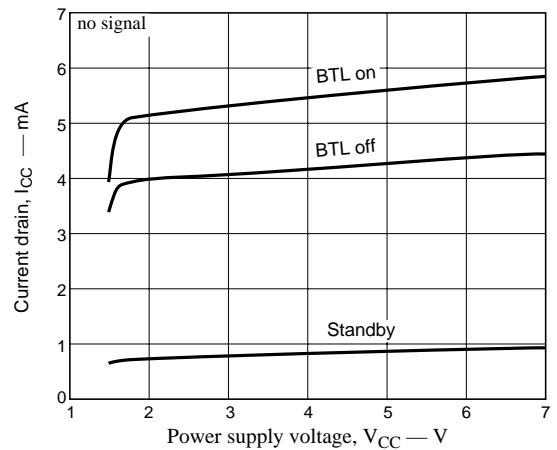

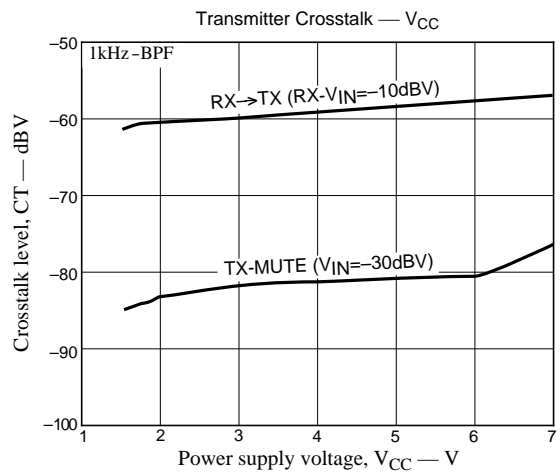
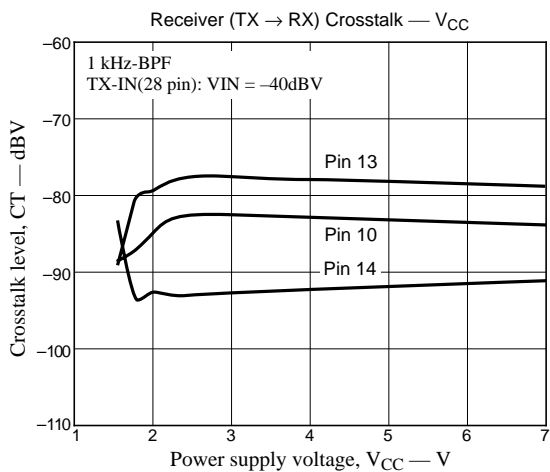
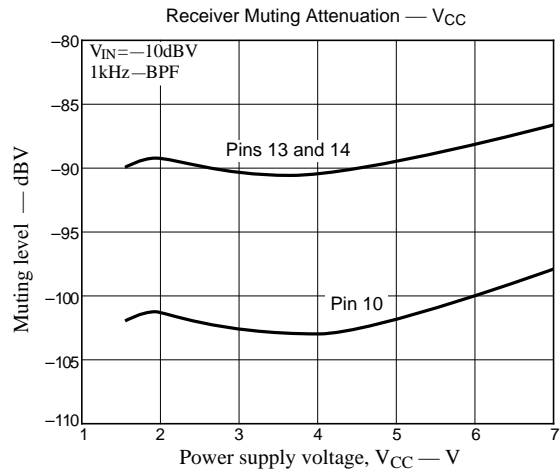
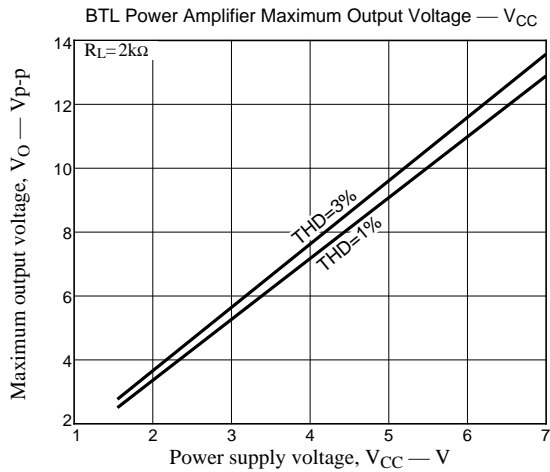
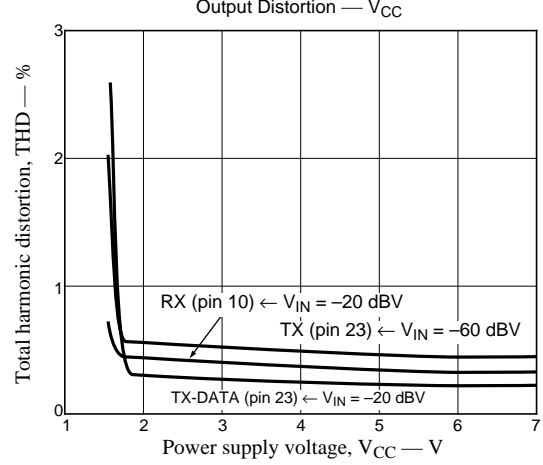
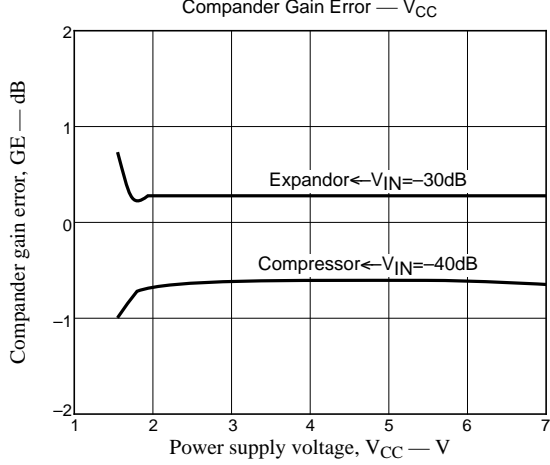
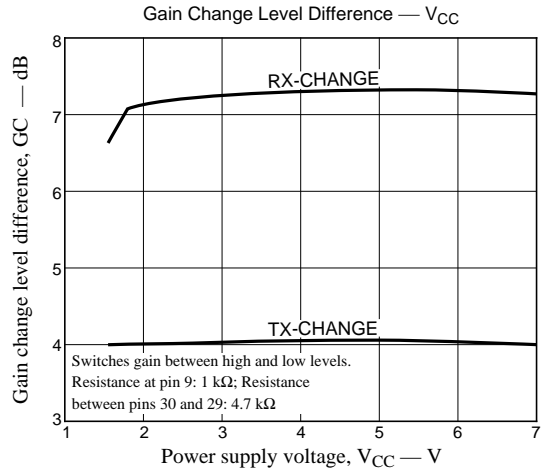
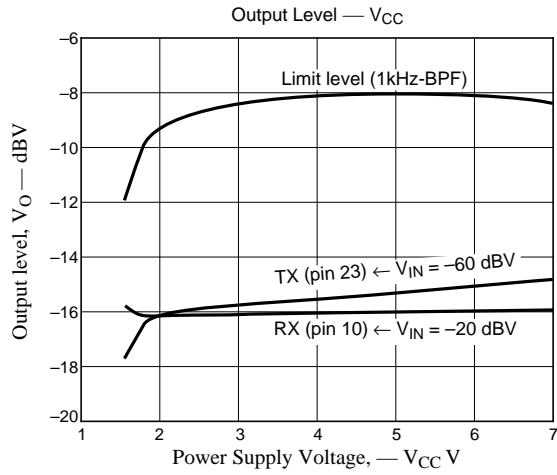

LA8638NV

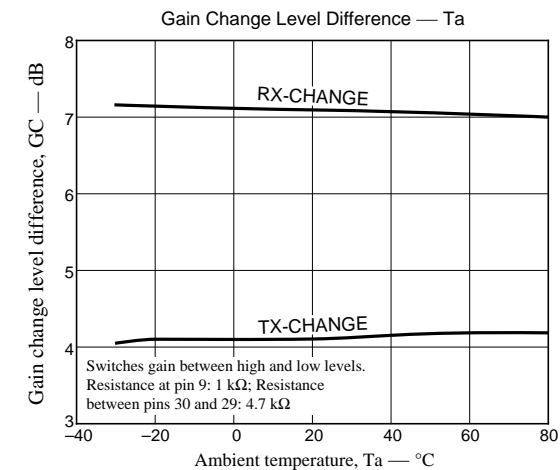
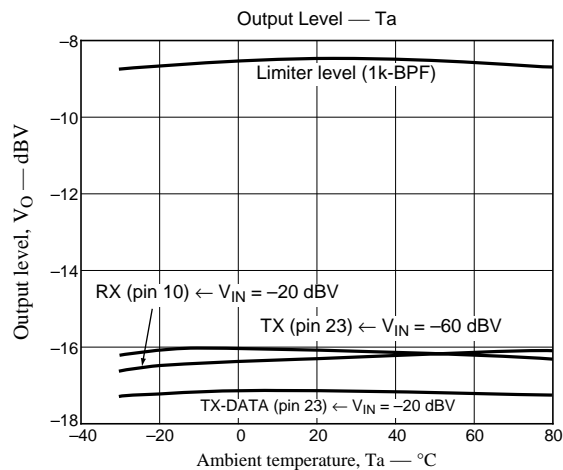
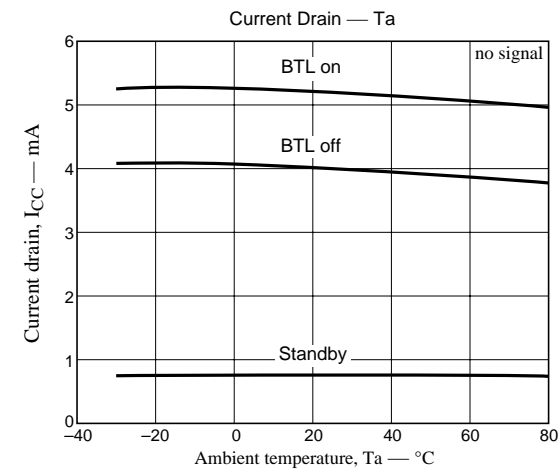
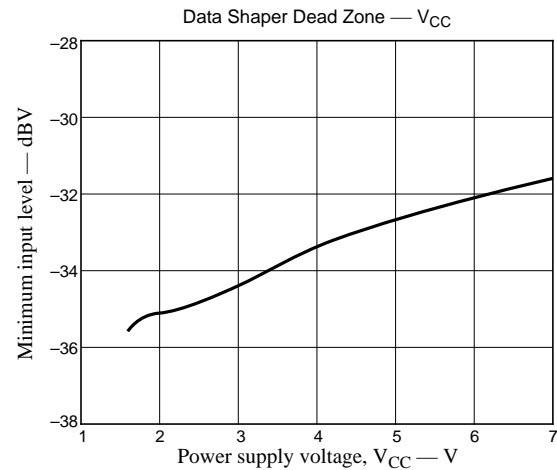
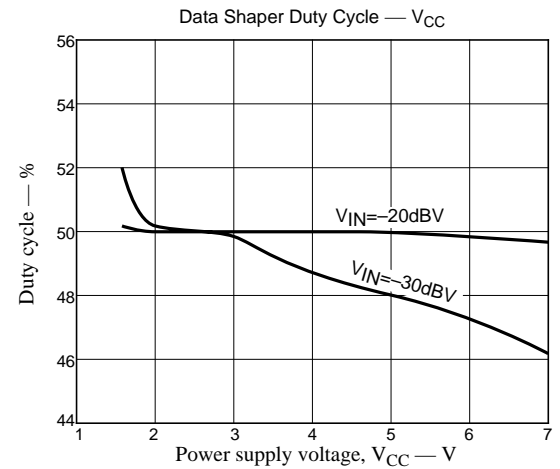
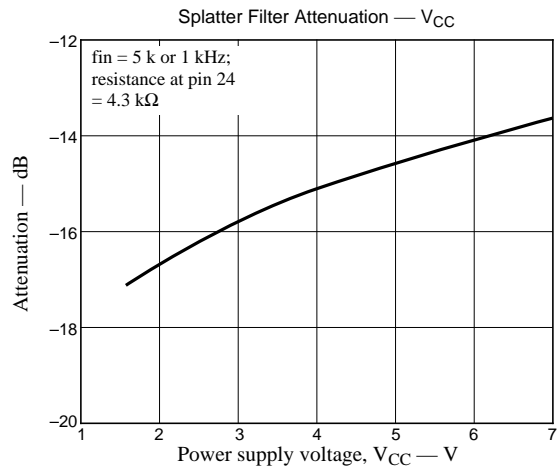
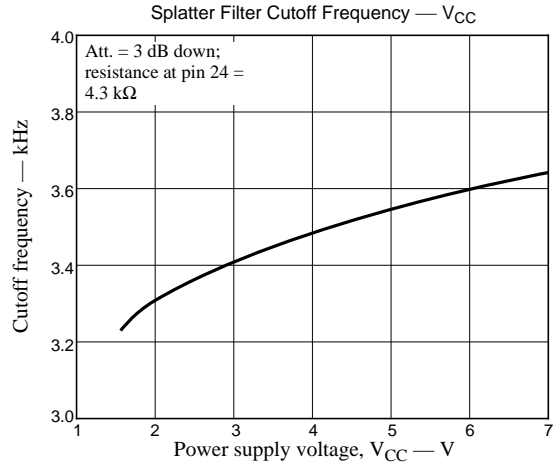
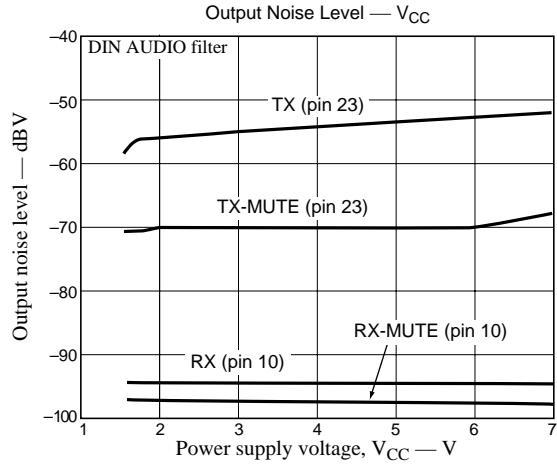

LA8638NV

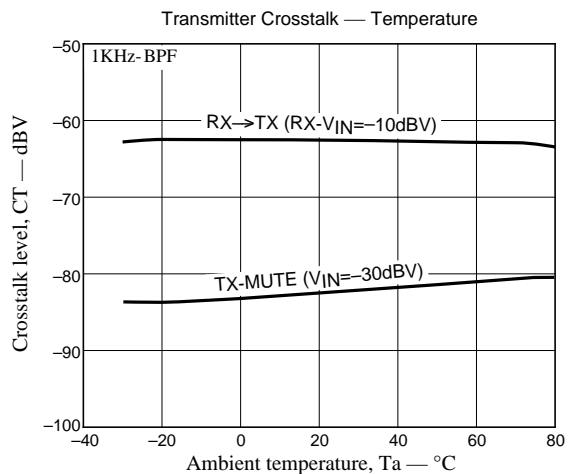
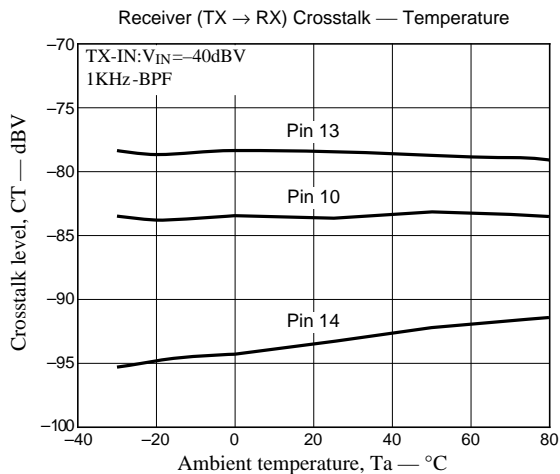
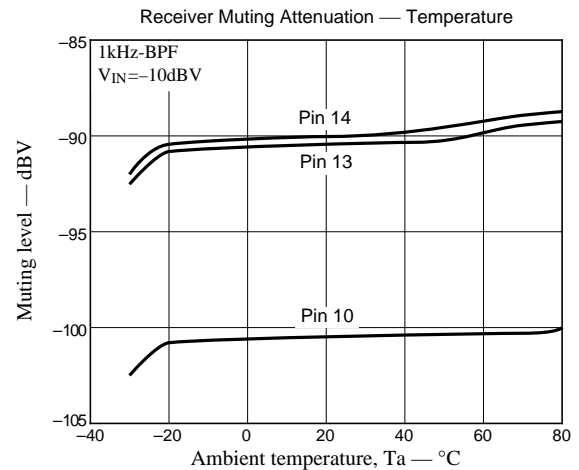
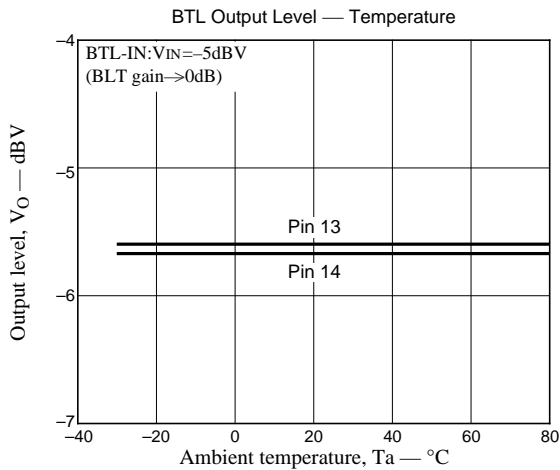
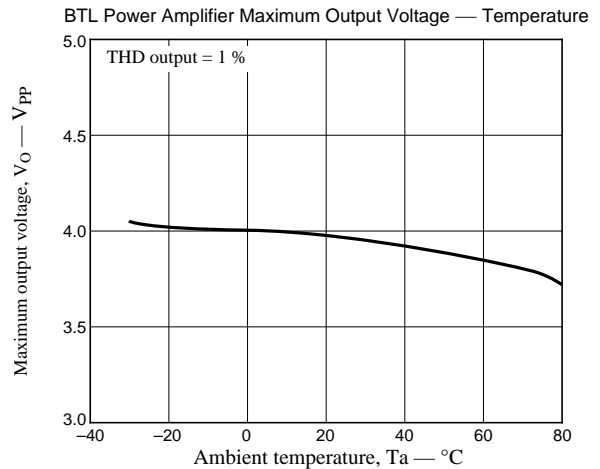
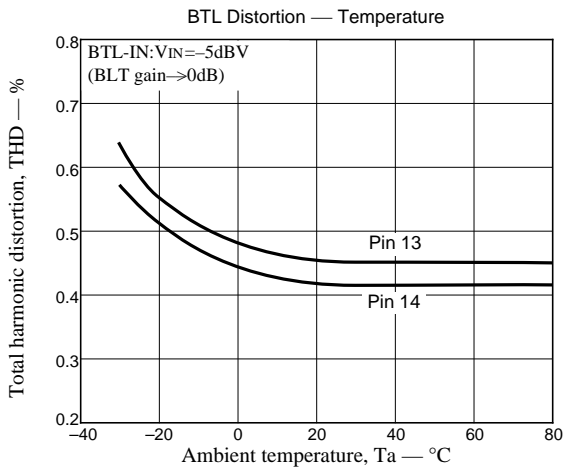
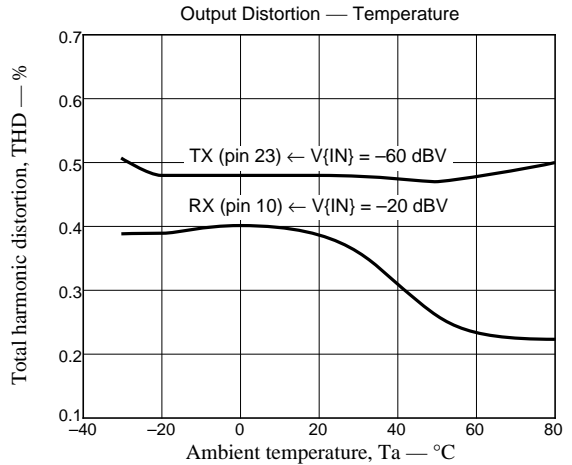
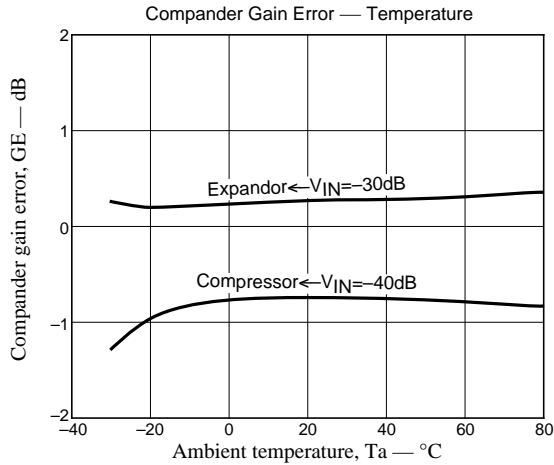

LA8638NV

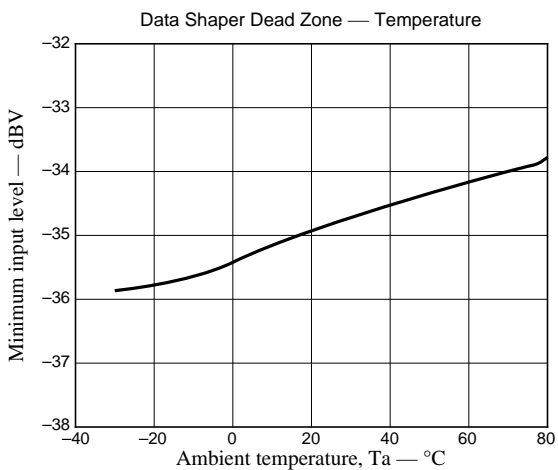
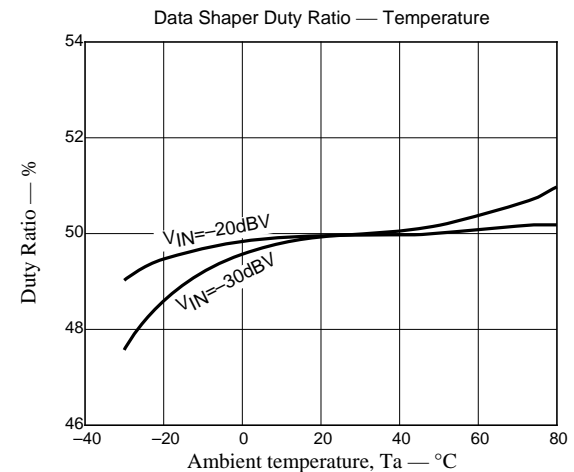
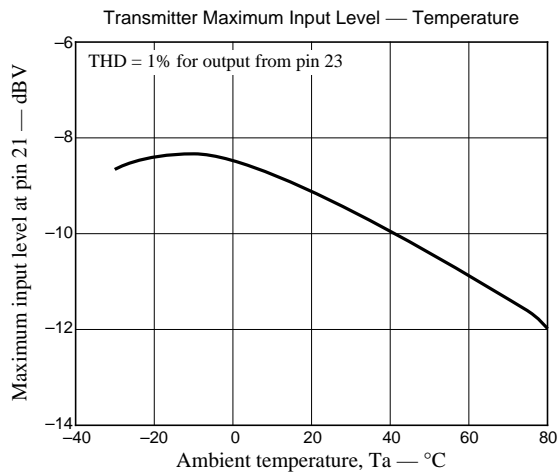
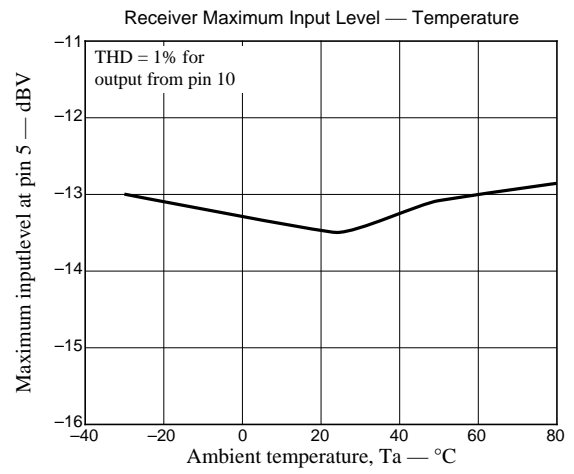
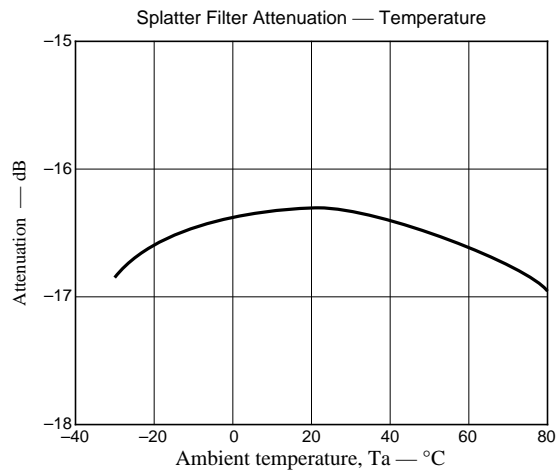
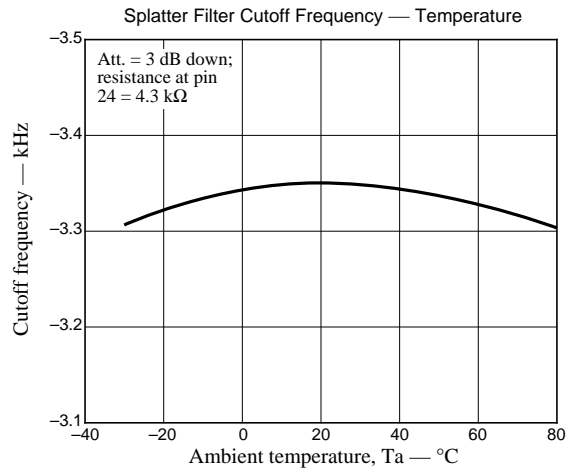
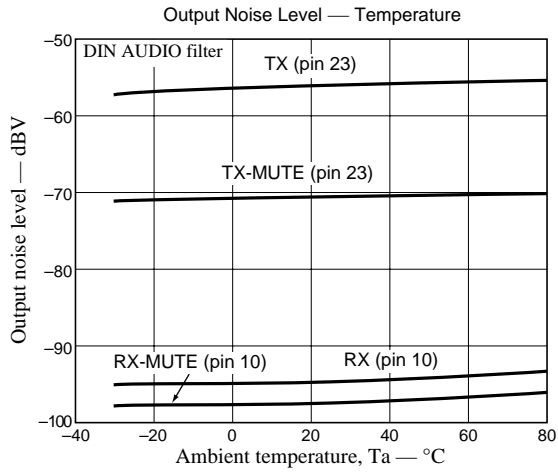

- Specifications of any and all SANYO products described or contained herein stipulate the performance, characteristics, and functions of the described products in the independent state, and are not guarantees of the performance, characteristics, and functions of the described products as mounted in the customer's products or equipment. To verify symptoms and states that cannot be evaluated in an independent device, the customer should always evaluate and test devices mounted in the customer's products or equipment.
- SANYO Electric Co., Ltd. strives to supply high-quality high-reliability products. However, any and all semiconductor products fail with some probability. It is possible that these probabilistic failures could give rise to accidents or events that could endanger human lives, that could give rise to smoke or fire, or that could cause damage to other property. When designing equipment, adopt safety measures so that these kinds of accidents or events cannot occur. Such measures include but are not limited to protective circuits and error prevention circuits for safe design, redundant design, and structural design.
- In the event that any or all SANYO products (including technical data, services) described or contained herein are controlled under any of applicable local export control laws and regulations, such products must not be exported without obtaining the export license from the authorities concerned in accordance with the above law.
- No part of this publication may be reproduced or transmitted in any form or by any means, electronic or mechanical, including photocopying and recording, or any information storage or retrieval system, or otherwise, without the prior written permission of SANYO Electric Co., Ltd.
- Any and all information described or contained herein are subject to change without notice due to product/technology improvement, etc. When designing equipment, refer to the "Delivery Specification" for the SANYO product that you intend to use.
- Information (including circuit diagrams and circuit parameters) herein is for example only; it is not guaranteed for volume production. SANYO believes information herein is accurate and reliable, but no guarantees are made or implied regarding its use or any infringements of intellectual property rights or other rights of third parties.

This catalog provides information as of November, 2003. Specifications and information herein are subject to change without notice.