

<b>SANYO</b>	No. 4931	<b>LA8637M</b>
	<b>Low-Voltage/Low-Power Componder IC</b>	

### Overview

The LA8637M is a compander IC that was developed to improve audio quality in transceiver systems such as cordless telephones by expanding the dynamic range of the audio signal and suppressing noise. In addition to including both a compressor circuit that compresses with a compression ratio of 1/2 (logarithmic) and an expander with an expansion factor of 2 (logarithmic), the LA8637M also integrates the following functions on the same chip: an ALC preamplifier, a BTL amplifier, a data shaper for received data, a muting function and a standby function. Thus the LA8637M is optimal as the compander/system IC in cordless telephone products.

### Applications

- Cordless telephones

### Functions

- Compressor  
ALC preamplifier, preemphasis amplifier, limiter, transmission data input analog switch, filter buffer amplifier
- Expander  
Filter buffer amplifier, de-emphasis amplifier, mute, BTL amplifier (100 Ω load)
- Level following data shaper (with hysteresis)
- Standby mode

### Features

- Easy implementation of transmission system and reception system base band signal processing
- Built-in BTL amplifier that supports mobile unit handsets
- Standby function to support battery saving
- Low voltage operation:  $V_{CC\ OP} = 1.8$  to 6 V

### Specifications

Maximum Ratings at  $T_a = 25^\circ\text{C}$

Parameter	Symbol	Conditions	Ratings	Unit
Maximum supply voltage	$V_{CC\ max}$		7	V
Allowable power dissipation	$P_d\ max$	$T_a \leq 75^\circ\text{C}$	250	mW
Operating temperature	$T_{opr}$		-20 to +75	$^\circ\text{C}$
Storage temperature	$T_{stg}$		-40 to +125	$^\circ\text{C}$

### Package Dimensions

unit: mm

3129-MFP36SD

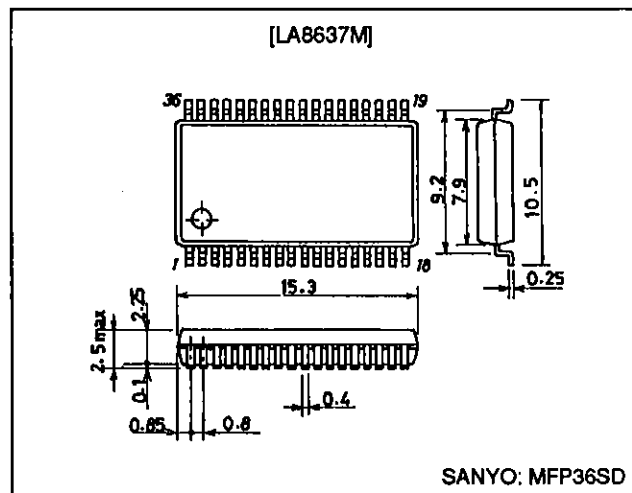

Operating Conditions at  $T_a = 25^\circ\text{C}$ 

Parameter	Symbol	Conditions	Ratings	Unit
Recommended supply voltage	$V_{CC}$		3	V
Operating supply voltage	$V_{CC\text{ OP}}$		1.8 to 6	V

Operating Characteristics at  $T_a = 25^\circ\text{C}$ ,  $V_{CC} = 3\text{ V}$ ,  $f = 1\text{ kHz}$ 

Parameter	Symbol	Conditions	min	typ	max	Unit
Quiescent current	$I_{CCO}$	No signal	5	8	12	mA
Standby current	$I_{STBY}$	No signal, standby mode (pin 24: low)	0.8	1	1.2	mA
[Preamplifier]						
Voltage gain	$V_{GP}$	$V_i = -60\text{ dBV}$	37	39	41	dB
Maximum voltage gain	$V_{GP\text{ max}}$	$V_i = -60\text{ dBV}$		50		dB
Total harmonic distortion	THD	$V_i = -40\text{ dBV}$ , ALC: ON		0.3	1.0	%
Input conversion noise voltage	$V_{NI}$	$R_g = 0\ \Omega$		1.5	5	$\mu\text{Vrms}$
ALC level	$V_{ALC}$	$V_i = -40\text{ dBV}$ , ALC: ON	350	420	490	mVrms
ALC range	ALC	Until the THD from the ALC circuit becomes 1%	35	40		dB
[Compressor] $V_{in\text{refc}} = -20\text{ dBV} = 0\text{ dB}$ , output: pin 16						
Input impedance	$r_i$			30		k $\Omega$
Output voltage	$V_{oc}$	$V_{in} = V_{in\text{refc}} = 0\text{ dB}$	-22	-20	-18	dBV
Gain error (1)	$G_{ec1}$	$V_{in} = -20\text{ dB}$	-0.5	0	+0.5	dB
Gain error (2)	$G_{ec2}$	$V_{in} = -40\text{ dB}$	-1.0	0	+1.0	dB
Total harmonic distortion	THD	$V_{in} = 0\text{ dB}$		0.25	1.0	%
Output noise voltage	$V_{NOC}$	$R_g = 620\ \Omega$ , $f = 20\text{ Hz}$ to $20\text{ kHz}$		0.15	1.0	mVrms
Crosstalk	$CT_C$	$RX-V_{in} = -20\text{ dBV}$ , $1\text{ kHz BPF}$		-75	-60	dB
[Analog Switch]						
Muting attenuation	$ATT_C$	$V_{in} = -20\text{ dB}$ , $1\text{ kHz BPF}$	60	75		dB
[Expander] $V_{in\text{refe}} = -20\text{ dBV} = 0\text{ dB}$						
Output voltage	$V_{oe}$	$V_{in} = V_{in\text{refe}} = 0\text{ dB}$	-22	-20	-18	dBV
Gain error (1)	$G_{ee1}$	$V_{in} = -20\text{ dB}$	-1.0	0	+1.0	dB
Gain error (2)	$G_{ee2}$	$V_{in} = -30\text{ dB}$	-1.5	0	+1.5	dB
Total harmonic distortion	THD	$V_{in} = 0\text{ dB}$		0.3	1.0	%
Output noise voltage	$V_{NOe}$	$R_g = 620\ \Omega$ , $f = 20\text{ Hz}$ to $20\text{ kHz}$		13	80	$\mu\text{Vrms}$
Muting attenuation	$ATT_e$	$V_{in} = 0\text{ dB}$ , $1\text{ kHz BPF}$	60	75		dB
Crosstalk	$CT_e$	$PRE\text{ AMP-}V_{in} = -60\text{ dBV}$ , $1\text{ kHz BPF}$		-95	-80	dB
Maximum output voltage	$V_{O\text{ max}}$	THD = 10%, $R_L = 10\text{ k}\Omega$	0.7	1.0		Vrms
[Limiter]						
Limiting voltage	$V_L$	$\Delta V = 0.6\text{ V}$ (voltage between pin 9 and pin 10)	0.27	0.3	0.33	Vp-p
[BTL Amplifier] Gain = 30 dB						
Voltage Gain	$V_{PWR}$	$V_{in} = -40\text{ dBV}$ , $R_L = 100\ \Omega$	27.5	29.5	31.5	dB
Total harmonic distortion	THD	$V_{in} = -40\text{ dBV}$ , $R_L = 100\ \Omega$		0.5	1.0	%
Maximum output power	$P_{O\text{ max}}$	THD = 10%, $R_L = 100\ \Omega$	15	30		mW
Maximum output voltage	$V_{O\text{ max}}$	THD = 10%, $R_L = 620\ \Omega$	4.0	5.5		Vp-p
Output noise voltage	$V_{NO}$	$R_g = 0\ \Omega$ , $R_L = 100\ \Omega$		120	800	$\mu\text{Vrms}$
[Compressor Low-Pass Filter]						
Maximum output voltage	$V_{O\text{ max}}$	THD = 1%, $R_L = 10\text{ k}\Omega$	450	550		mVrms
[Expander Low-Pass Filter] $V_B = 1.5\text{ V}$ ( $V_B$ : low-pass filter bias voltage)						
Maximum output voltage	$V_{O\text{ max}}$	THD = 1%, $R_L = 10\text{ k}\Omega$	400	500		mVrms
[Data Shaper]						
Duty	$D_{UTY}$	$V_{in} = -15\text{ dBV}$	45	50	55	%
Hysteresis	$W_{HYS}$		45	70	100	mV
Output high level voltage	$V_{OH}$	$R_L = 100\text{ k}\Omega$	2.8			V
Output low level voltage	$V_{OL}$	$R_L = 100\text{ k}\Omega$			0.3	V
[Standby]						
Standby voltage	$V_{ST}$	Pin 24			0.7	V
Standby current	$I_{ST}$	Pin 24 outflow current			30	$\mu\text{A}$

Continued on next page.

# LA8637M

Continued from preceding page.

Parameter	Symbol	Conditions	min	typ	max	Unit
[Digital Input Characteristics]						
Input low level voltage	$V_{IL}$	Pins 27 and 28			0.65	V
Input high level voltage	$V_{IH}$	Pins 27 and 28	$0.6 V_{CC}$			V
Input low level current	$I_{IL}$	Pins 27 and 28, $V_I = 0.2 V$			100	$\mu A$
Input high level current	$I_{IH}$	Pins 27 and 28, $V_I = 2 V$			5	$\mu A$

## Internal Equivalent Circuit Block Diagram

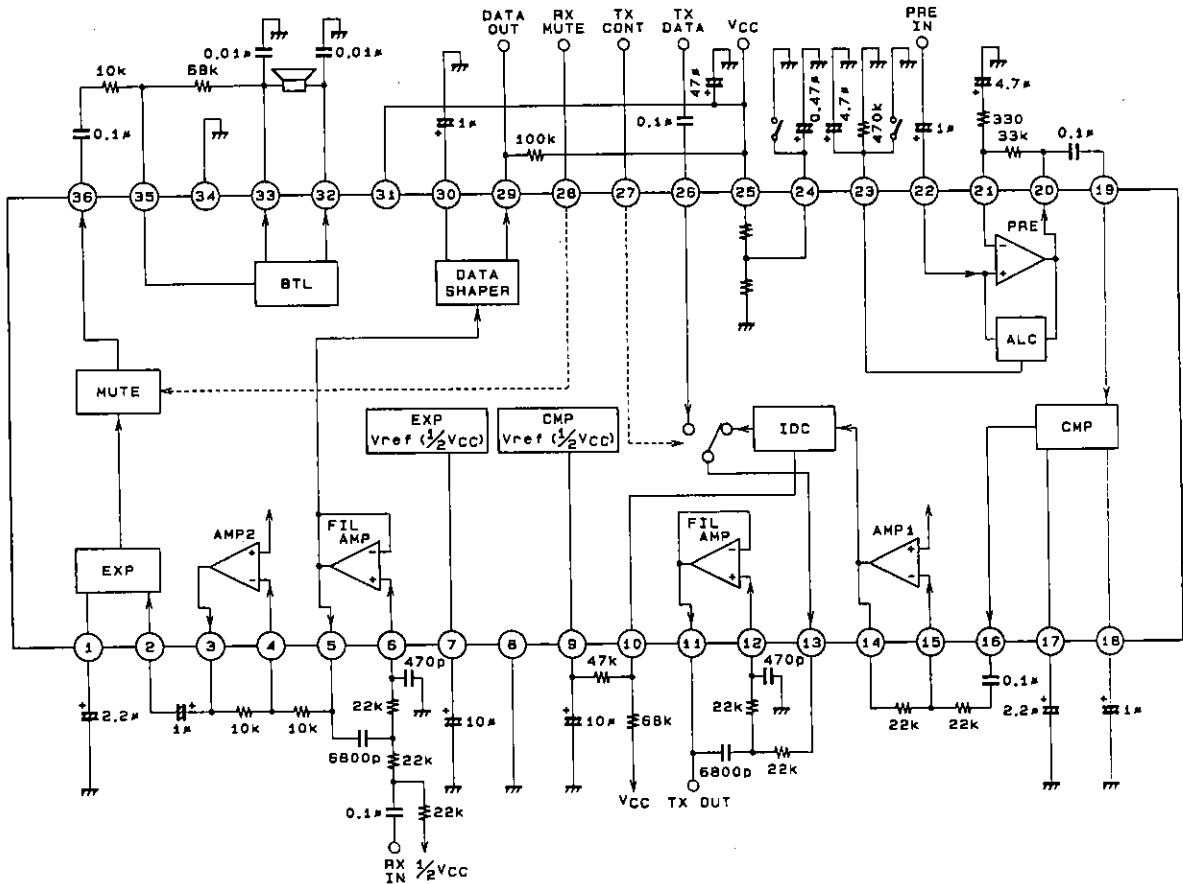

402613

Unit (resistance :  $\Omega$ , capacitance : F)



LA8637M

Pin Functions

Pin No.	Symbol	Internal equivalent circuit	Protective diode	
			V <sub>CC</sub> side	Ground side
1 2	EXP.V <sub>REC</sub> EXP.IN	<p style="text-align: right;">A02816</p>	○ ○	○ ○
3 4	OP.OUT1 OP.IN1	<p style="text-align: right;">A02816</p>	○ ○	○ ○
5 6	FIL.OUT1 FIL.IN1	<p style="text-align: right;">A02817</p>	○ ○	○ ○
7 9 24	EXP.V <sub>REF</sub> CMP.V <sub>REF</sub> STAND-BY	<p style="text-align: right;">A02818</p>	○ ○ ○	○ ○ ○
10	IDC.ADJ	<p style="text-align: right;">A02819</p>	○	○

Continued on next page.

# LA8637M

Continued from preceding page.

Pin No.	Symbol	Internal equivalent circuit	Protective diode	
			Vcc side	Ground side
11 12	FIL.OUT2 FIL.IN2	<p style="text-align: right;">A02820</p>	○ ○	○ ○
13 26	TX.OUT DATA IN	<p style="text-align: right;">A02821</p>	○ ○	○ ○
14 15	OP OUT2 OP IN2	<p style="text-align: right;">A02822</p>	○ ○	○ ○
16 17 18 19	CMP.OUT CMP.VREC CMP.NF CMP.IN	<p style="text-align: right;">A02823</p>	○ ○ ○ ○	○ ○ ○ ○
20 21 22	PRE OUT PRE NF PRE IN	<p style="text-align: right;">A02824</p>	○ — —	○ ○ ○

Continued on next page.

LA8637M

Continued from preceding page.

Pin No.	Symbol	Internal equivalent circuit	Protective diode	
			V <sub>CC</sub> side	Ground side
23	ALC.CT		○	○
27 28	TX.CONT RX.MUTE		○ ○	○ ○
29 30	DATA OUT V.HOLD		— ○	○ ○
32 33 35	BTL OUT2 BTL OUT1 BTL IN		— — —	○ ○ ○
36	EXP.OUT		○	○

Note: All V<sub>CC</sub> side diodes are connected to V<sub>CC</sub> at pin 25.

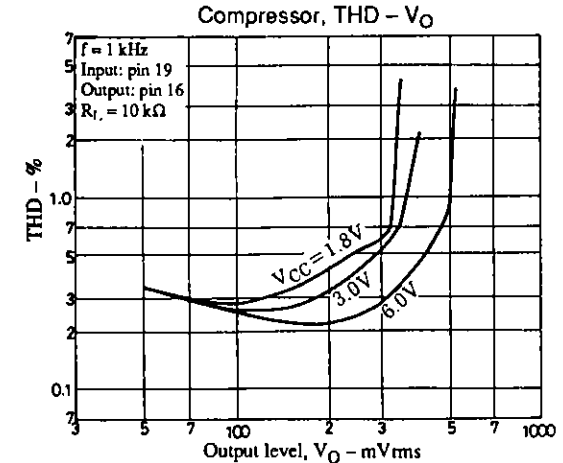
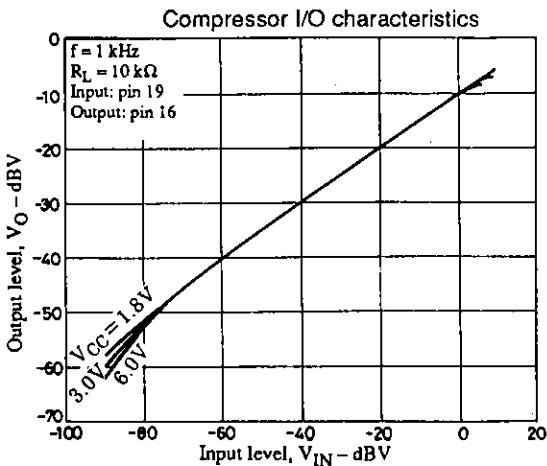
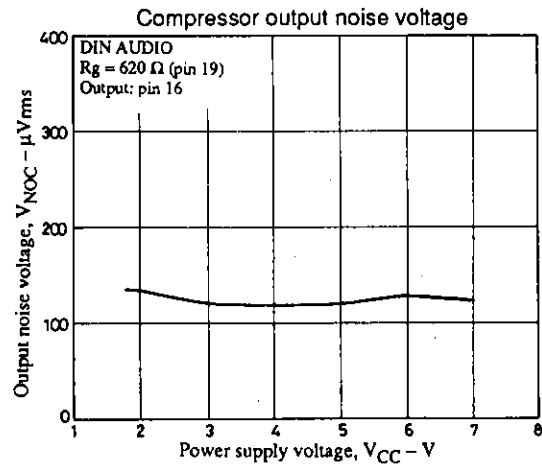
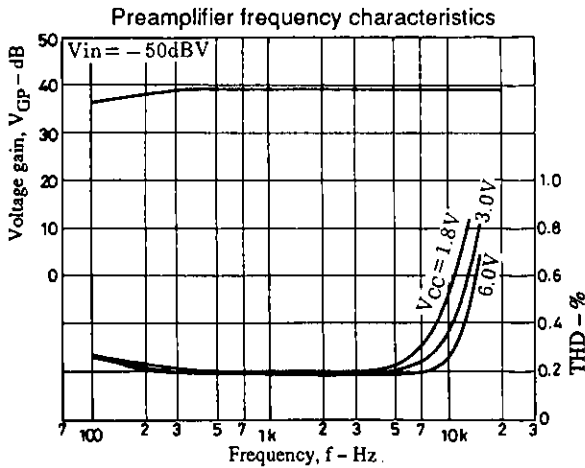
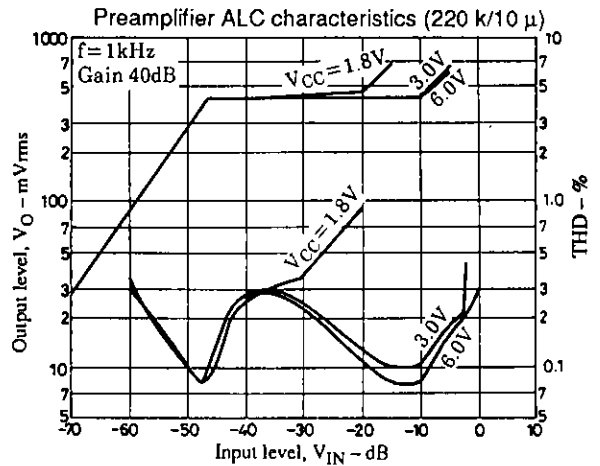
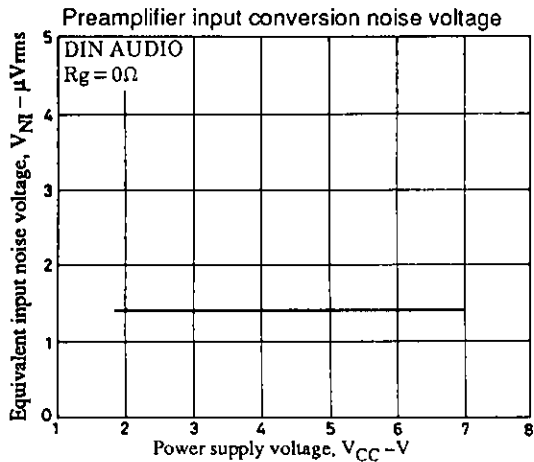
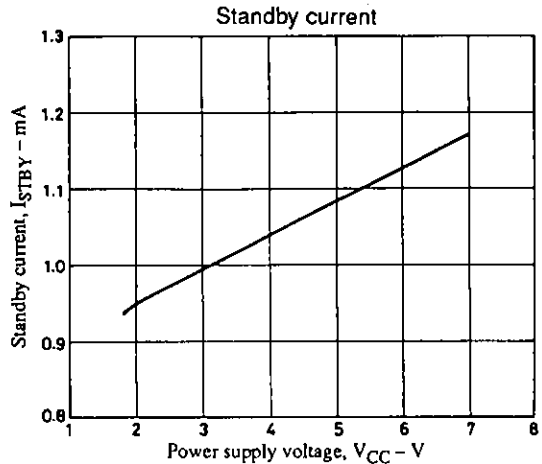
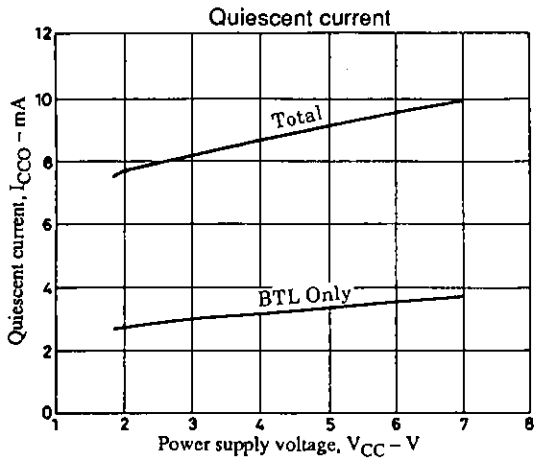



Expander output noise voltage

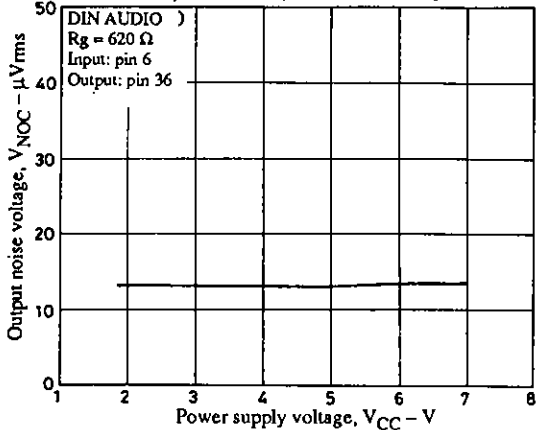

Expander characteristics

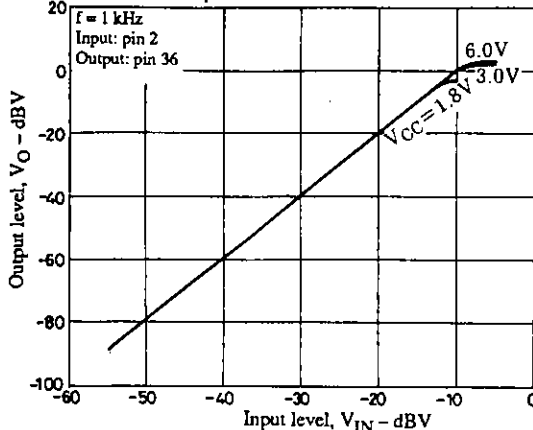

Expander total harmonic distortion, THD - V\_O

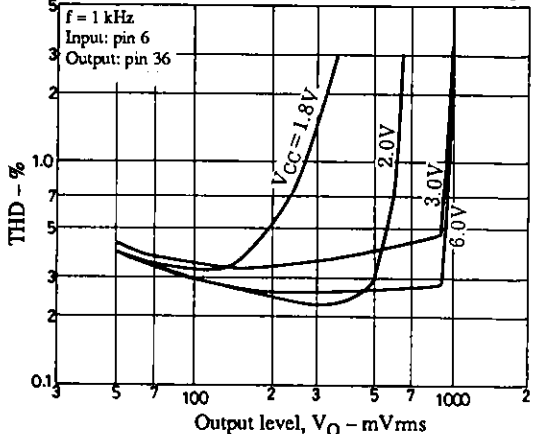

IDC characteristics

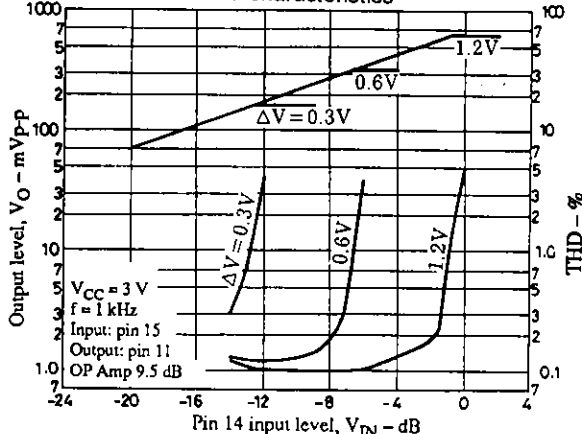

Limiter level - ΔV characteristics

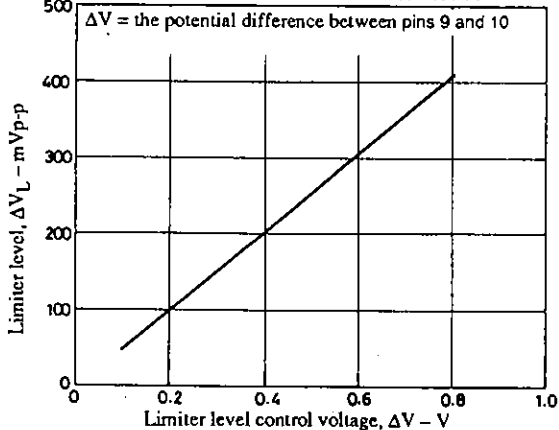

TX system filter amplifier I/O characteristics

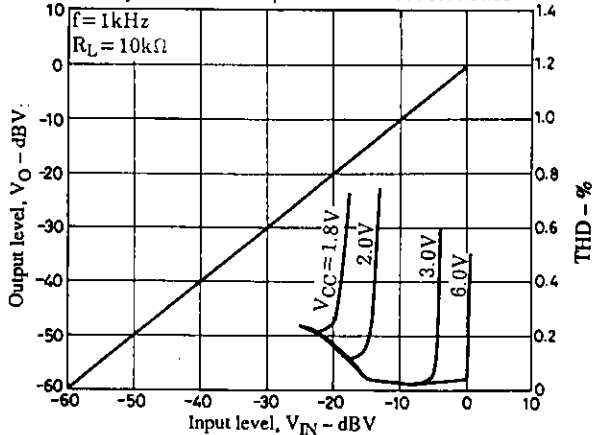

RX system filter amplifier I/O characteristics

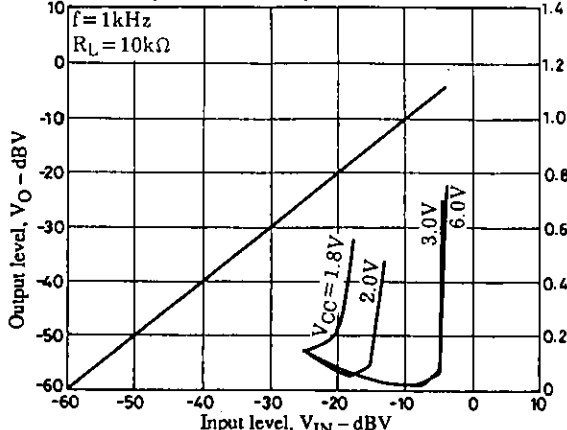

BTL amplifier output noise

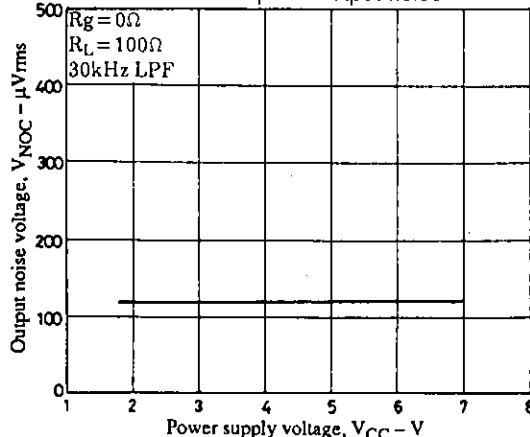

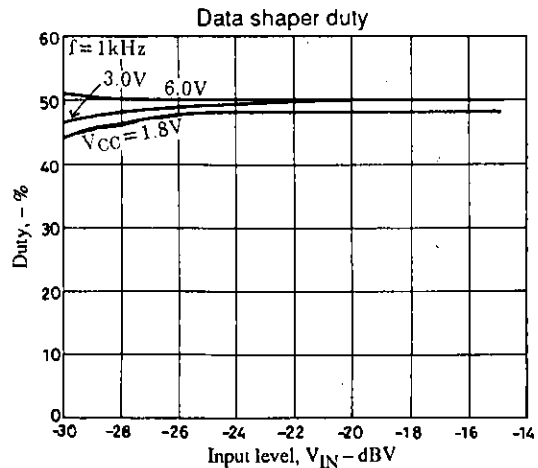
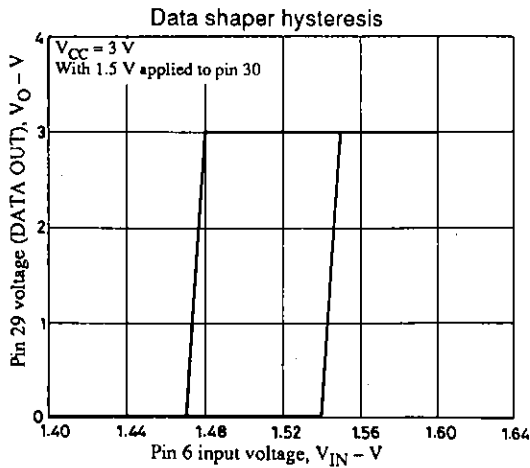
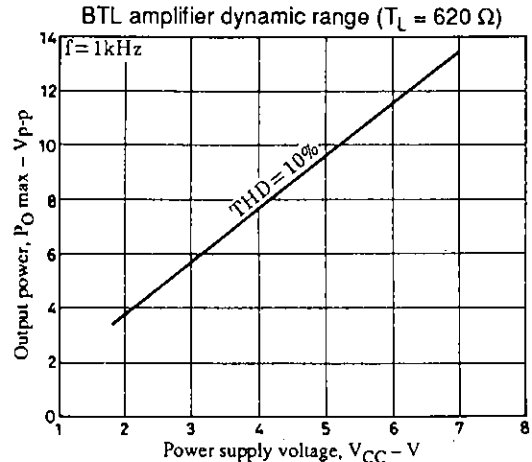
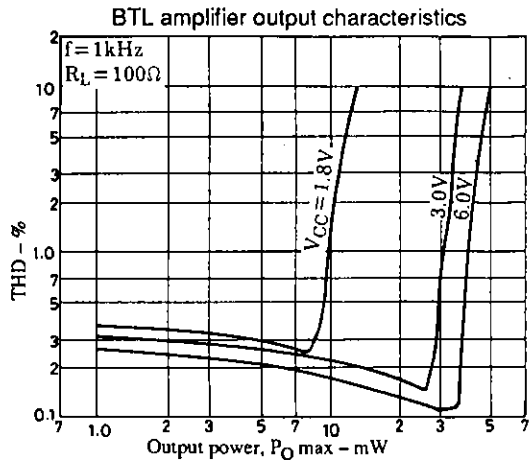
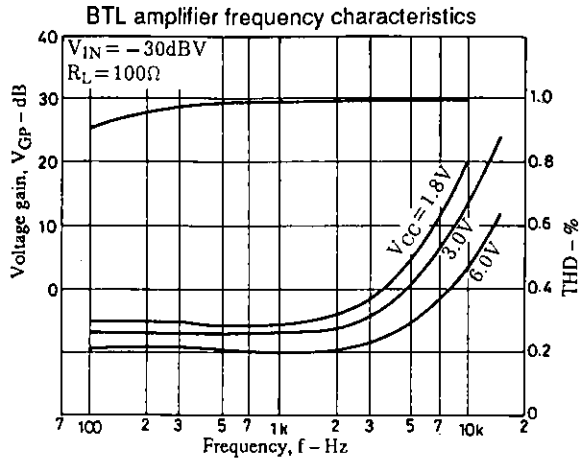
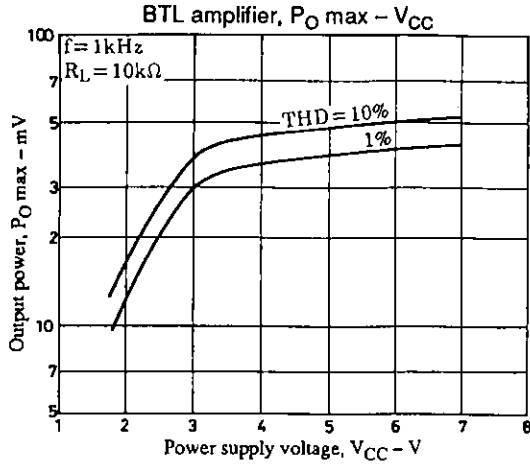

- No products described or contained herein are intended for use in surgical implants, life-support systems, aerospace equipment, nuclear power control systems, vehicles, disaster/crime-prevention equipment and the like, the failure of which may directly or indirectly cause injury, death or property loss.
- Anyone purchasing any products described or contained herein for an above-mentioned use shall:
  - ① Accept full responsibility and indemnify and defend SANYO ELECTRIC CO., LTD., its affiliates, subsidiaries and distributors and all their officers and employees, jointly and severally, against any and all claims and litigation and all damages, cost and expenses associated with such use;
  - ② Not impose any responsibility for any fault or negligence which may be cited in any such claim or litigation on SANYO ELECTRIC CO., LTD., its affiliates, subsidiaries and distributors or any of their officers and employees jointly or severally.
- Information (including circuit diagrams and circuit parameters) herein is for example only; it is not guaranteed for volume production. SANYO believes information herein is accurate and reliable, but no guarantees are made or implied regarding its use or any infringements of intellectual property rights or other rights of third parties.