

SANYO	No. 3781B	LA8606M
	Cordless Telephone Signal Processor	

OVERVIEW

The LA8606M is a signal processor IC for use in cordless telephone. It incorporates 1st and 2nd IF mixers, IF amplifier, quadrature detector, noise detector and noise amplifier on-chip, greatly reducing the number of external components required. Also incorporated are an S-meter driver, preamplifier, power amplifier, battery checker, LPF buffer, BPF and data shaper.

The LA8606M operates from a 1.8 to 6.0V supply and is available in 44-pin QIPs.

FEATURES

- 1st and 2nd IF mixers
- IF amplifier
- Quadrature detector
- Noise detector
- Noise amplifier
- S-meter driver
- LPF buffer, BPF and data shaper
- Controllable preamplifier for either the limiter or the ALC
- Power amplifier and power-down circuit
- Battery check function
- 1.8 to 6.0 V supply
- 44-pin QIP

PINOUT

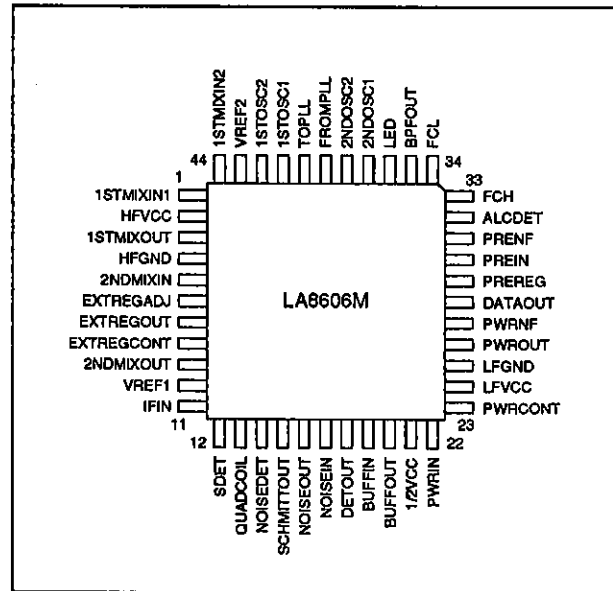

PACKAGE DIMENSIONS

Unit: mm

3148-QIP44MA

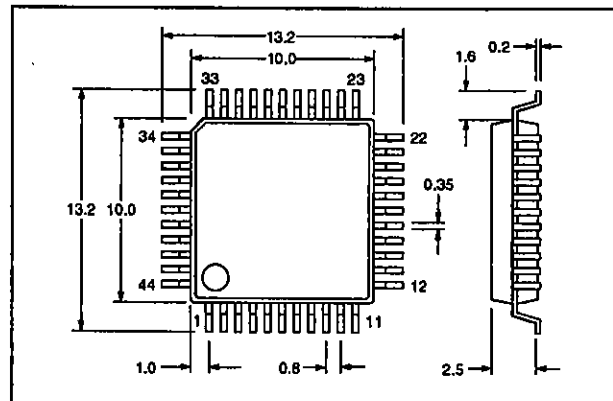

BLOCK DIAGRAM

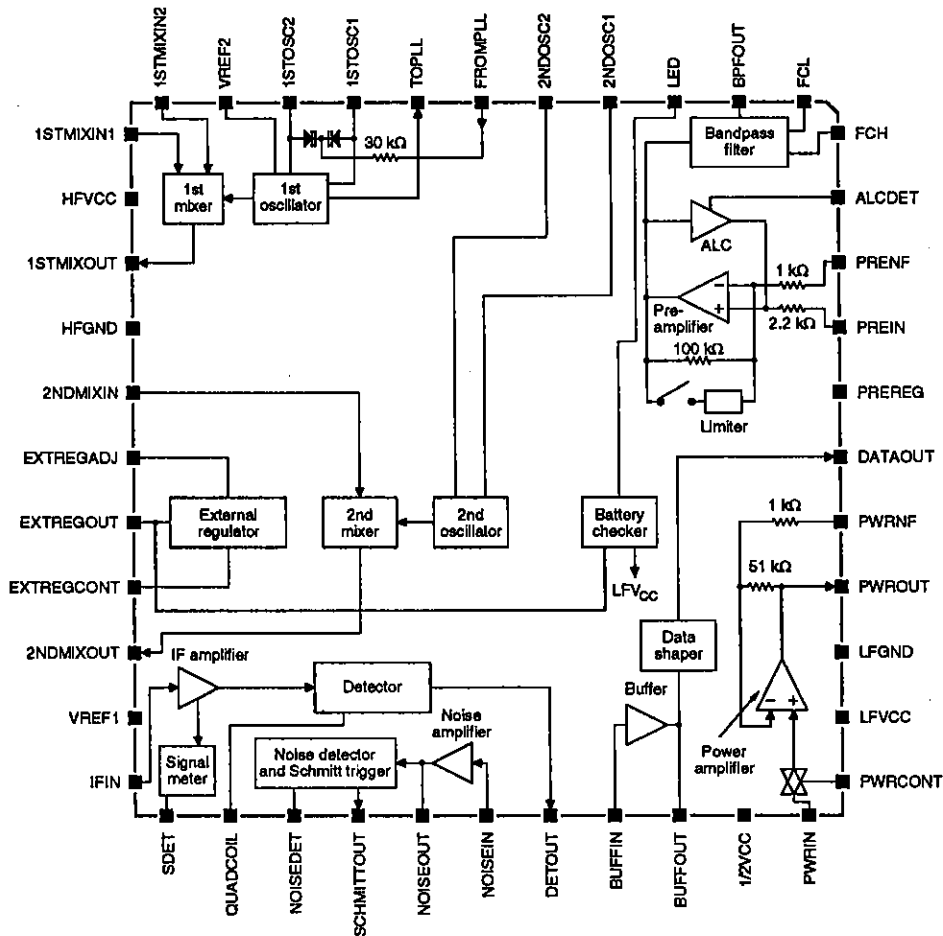

PIN DESCRIPTION

Number	Name	Equivalent circuit	Description
1	1STMIXIN1		1st IF mixer inputs. Nominal voltage is 1.2 V.
44	1STMIXIN2		
2	HFVCC		Supply for high-frequency circuitry. Nominal voltage is 3.8 V.
3	1STMIXOUT		1st IF mixer output. Nominal voltage is 2.85 V.

LA8606M

Number	Name	Equivalent circuit	Description
4	HFGND		Ground for high-frequency circuitry
5	2NDMIXIN		2nd IF mixer input. Nominal voltage is 1.2 V.
6	EXTREGADJ		Voltage regulator external PNP transistor connections. The nominal voltages of EXTREGADJ and EXTREGCONT are 1.2 V and 3.1 V, respectively.
7	EXTREGOUT		
8	EXTREGCONT		
9	2NDMIXOUT		2nd IF mixer output. Nominal voltage is 3.3 V.
10	VREF1		Voltage reference output. Nominal voltage is 1.2 V.
11	IFIN		IF amplifier input. Nominal voltage is 1.2 V.
12	SDET		Signal meter output. Nominal voltage is 0.7 V.

LA8606M

Number	Name	Equivalent circuit	Description
13	QUADCOIL		Quadrature detector phase coil connection. Nominal voltage is 3.8 V.
14	NOISEDET		Noise detector output. Nominal voltage is 1.4 V with no input signal.
15	SCHMITTOUT		Schmitt trigger output. Nominal voltage is 0.1 V.
16	NOISEOUT		External RC noise filter connections. Nominal voltages are 0.97 V.
17	NOISEIN		
18	DETOUT		FM detector output. Nominal output voltage is 1.2 V.
19	BUFFIN		3rd-order Butterworth filter external RC network connections. The nominal voltages of BUFFIN and BUFFOUT are 1.12 V and 1.2 V, respectively.
20	BUFFOUT		Data signal output
28	DATAOUT		
21	1/2VCC		Power amplifier voltage reference output. Nominal voltage is 1.9 V.
22	PWRIN		Power amplifier input. Nominal voltage is 1.9 V.
23	PWRCONT		Active-HIGH power amplifier control input. HIGH when 1.6 V or greater, and LOW when 0.8 V or lower.
24	LFVCC		Supply for low-frequency circuitry. Nominal voltage is 3.8 V.

LA8606M

Number	Name	Equivalent circuit	Description
25	LFGND		Ground for low-frequency circuitry
26	PWROUT		Power amplifier output. Nominal voltage is 1.6 V.
27	PWRNF		Power amplifier negative feedback input. Nominal voltage is 1.9 V.
29	PREREC		Preamplifier reference voltage output. Nominal voltage is 2.6 V.
30	PREIN		Preamplifier input. Nominal voltage is 2.6 V.
31	PRENF		Preamplifier negative feedback input. Nominal voltage is 2.6 V.
32	ALCDET		ALC detector external RC network connection and ALC or limiter mode select input. Nominal voltage is 1.0 V with no input signal in ALC mode.
33	FCH		Highpass filter capacitor connection. Nominal voltage is 2.6 V.
34	FCL		Lowpass filter capacitor connection. Nominal voltage is 2.6 V.
35	BPFOUT		Bandpass filter output. Nominal voltage is 2.6 V.

LA8606M

Number	Name	Equivalent circuit	Description
36	LED		LED driver output
37	2NDOSC1		2nd IF oscillator external crystal oscillator connection. The nominal voltages of 2NDOSC1 and 2NDOSC2 are 3.1 V and 3.8 V, respectively.
38	2NDOSC2		
39	FROMPLL		VCO control input. The input voltage range is 0.7 to 5.0 V.
40	TOPLL		1st IF oscillator buffer output. Nominal voltage is 2.2 V.
41	1STOSC1		1st IF oscillator external oscillator network connections. Nominal voltages are 0.7 V.
42	1STOSC2		
43	VREF2		1st IF oscillator and mixer reference voltage output. Nominal voltage is 1.2 V.

SPECIFICATIONS

Absolute Maximum Ratings

Parameter	Symbol	Rating	Unit
Supply voltage	V_{DD}	8	V
Output current	I_o	30	mA
Power dissipation	P_D	600	mW
Operating temperature range	T_{opr}	-20 to 75	°C
Storage temperature range	T_{stg}	-40 to 150	°C

Note

The device should not be completely immersed during the soldering process.

LA8606M

Recommended Operating Conditions

$T_a = 25\text{ }^\circ\text{C}$

Parameter	Symbol	Rating	Unit
Supply voltage	V_{DD}	3.8	V
Supply voltage range	V_{DD}	1.8 to 6.0	V

Electrical Characteristics

$V_{CC} = 3.8\text{ V}$, $T_a = 25\text{ }^\circ\text{C}$

Parameter	Symbol	Condition	Rating			Unit
			min	typ	max	
Supply current	I_{CC}	No input signal. PWRCONT is HIGH.	6	9	12	mA
		No input signal. PWRCONT is LOW.	5	8	11	
LOW-level input voltage	V_{IL}		-	-	0.8	V
HIGH-level input voltage	V_{IH}		1.6	-	-	V
LOW-level output voltage	V_{OL}		-	-	0.5	V
HIGH-level output voltage	V_{OH}		3.0	-	-	V

External voltage regulator

$V_{CC} = 3.8\text{ V}$, $T_a = 25\text{ }^\circ\text{C}$ unless otherwise noted

Parameter	Symbol	Condition	Rating			Unit	
			min	typ	max		
Output voltage range	V_O	$V_{CC} = 1.8\text{ to }6.0\text{ V}$	1.6	-	5.8	V	
Line regulation	V_{LINE}	$V_{EXTREGOUT} = 3\text{ V}$ $V_{LINE} = V_{CC} - V_{EXTREGOUT}$	$V_{CC} = 3.2\text{ to }6.0\text{ V}$	-	-	60	mV
			$V_{CC} = 1.8\text{ to }3.2\text{ V}$	-	0.2	-	V
Load regulation	V_{LOAD}	$I_O = 1\text{ to }30\text{ mA}$	-	-	60	mV	

High-frequency block

$V_{CC} = 3.8\text{ V}$, $T_a = 25\text{ }^\circ\text{C}$, $f_c = 49.830\text{ MHz}$, $f_{mod} = 1\text{ kHz}$, $\Delta f = \pm 3\text{ kHz}$. For AM signals, $f_{mod} = 400\text{ Hz}$, 30% modulation unless otherwise noted

Parameter	Symbol	Condition	Rating			Unit
			min	typ	max	
Maximum input frequency	$f_i\text{ max}$		-	50	-	MHz
1st IF mixer conversion gain	V_{GMIX1}		-	18	-	dB
2nd IF mixer conversion gain	V_{GMIX2}		-	22	-	dB
Demodulator output voltage	V_O	1st mixer input voltage = 80 dB μ	70	110	140	mV _{rms}
Total harmonic distortion	THD _{HF}		-	0.5	2.0	%
AM rejection	AMR	$V_i = 80\text{ dB}\mu$, amplitude modulated	30	40	-	dB

LA8606M

Parameter	Symbol	Condition	Rating			Unit
			min	typ	max	
Signal-to-noise ratio	S/N	$V_I = 80 \text{ dB}\mu$, no modulation	54	58	-	dB
		$V_I = 8 \text{ dB}\mu$, no modulation	14	20	-	
Noise detector output voltage	V_{ND}	$V_I = 10 \text{ dB}\mu$	-	1.4	-	V
		$V_I = 40 \text{ dB}\mu$	-	0	-	
Signal meter output voltage	V_{SM}	$V_I = 10 \text{ dB}\mu$	0.2	0.6	0.9	V
		$V_I = 50 \text{ dB}\mu$	0.8	1.1	1.4	
Schmitt-trigger output voltage	V_{SH}	$V_I = 21 \text{ dB}\mu$	-	-	0.5	V
		$V_I = 37 \text{ dB}\mu$	3.5	-	-	
Schmitt-trigger level	SH		21	29	37	dB μ
-3 dB limiting sensitivity	-3dBLS		-	-	10	dB μ
First mixer third-order intercept	3rdIM			-23		dBm

Data shaper

$V_{CC} = 3.8 \text{ V}$, $T_a = 25 \text{ }^\circ\text{C}$, $f_i = 1 \text{ kHz}$

Parameter	Symbol	Condition	Rating			Unit
			min	typ	max	
Duty cycle	Duty		-	50	-	%

Filters

$V_{CC} = 3.8 \text{ V}$, $T_a = 25 \text{ }^\circ\text{C}$, $f_i = 1 \text{ kHz}$, $V_I = 200 \text{ mV}_{\text{rms}}$ unless otherwise noted

Parameter	Symbol	Condition	Rating			Unit
			min	typ	max	
LPF attenuation	α_{LPF}	$f_i = 3.7 \text{ kHz}$	1.5	3.0	4.5	dB
		$f_i > 3.7 \text{ kHz}$	-	18	-	dB/octave
BPF gain	G_{BPF}		-	0	-	dB
BPF attenuation	α_{BPF}	$f_i = 250 \text{ Hz}$	0.5	2.5	5.5	dB
		$f_i = 3.7 \text{ kHz}$	1.0	3.1	6.0	dB
			-	6	-	dB/octave

Preamplifier

$V_{CC} = 3.8 \text{ V}$, $T_a = 25 \text{ }^\circ\text{C}$, $f_i = 1 \text{ kHz}$, $V_I = 2 \text{ mV}_{\text{rms}}$ unless otherwise noted

Parameter	Symbol	Condition	Rating			Unit
			min	typ	max	
Voltage gain	V_{GPRE}		37	39	41	dB
Total harmonic distortion	THD _{PRE}		-	0.1	0.5	%
Input conversion noise voltage	V_{NI}	$R_G = 0 \text{ } \Omega$	-	1	3	μV
ALC range	ALC	3 dB ALC error	30	40	-	dB

LA8606M

Parameter	Symbol	Condition	Rating			Unit
			min	typ	max	
ALC level	V_{ALC}		1.6	1.9	2.2	V
Limiter level	V_{LIM}		2.0	2.3	2.6	V

Power amplifier

$V_{CC} = 3.8$ V, $T_a = 25$ °C, $f_i = 1$ kHz, $V_i = 10$ mV_{rms} unless otherwise noted

Parameter	Symbol	Condition	Rating			Unit
			min	typ	max	
Voltage gain	V_{GPWR}	$R_L = 100$ Ω, $V_i = -40$ dBV	32	34	36	dB
Total harmonic distortion	THD_{PWR}	$R_L = 100$ Ω, $V_i = -40$ dBV	–	1.5	3.0	%
Maximum output power	P_O max	$R_L = 100$ Ω, THD = 10%	10	14	–	mW
Output noise voltage	V_{NO}	$R_g = 0$ Ω, DIN audio filter	–	0.2	0.4	mV _{rms}
Crosstalk rejection	CT	PWRCONT connected to ground	45	63	–	dB

Battery checker

$V_{CC} = 3.8$ V, $T_a = 25$ °C

Parameter	Symbol	Condition	Rating			Unit
			min	typ	max	
LED ON voltage	V_{ON}	See note.	0.2	0.3	0.4	V
Hysteresis	LED_{HYS}		–	100	–	mV

Note

$$V_{ON} = V_{CC} - V_{EXTREGOUT}$$

Measurement Circuit

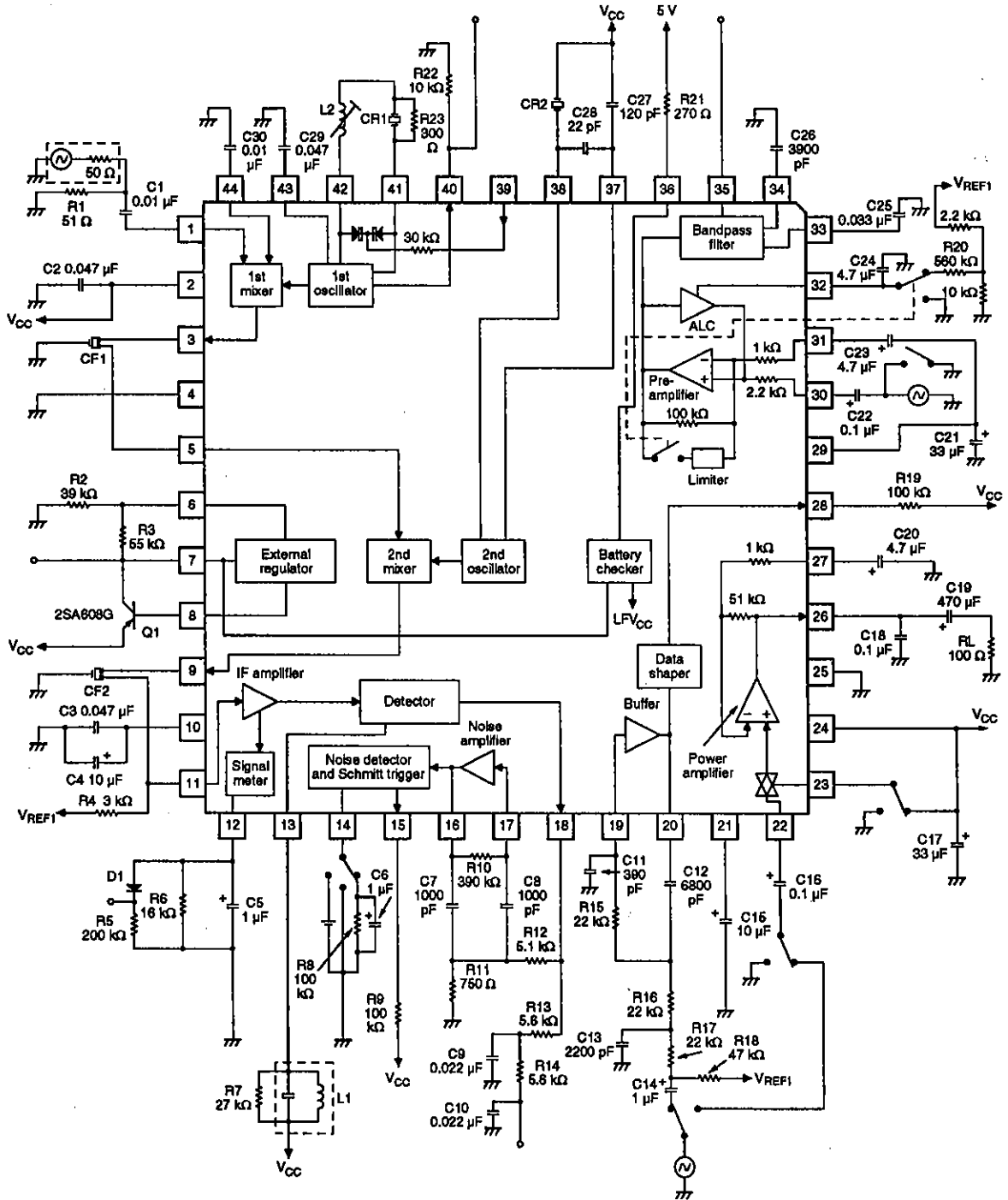

- CF1 Murata SFE10.7MS2
- CF2 Murata SFU455A
- L1 Mitsumi WK40337
- L2 Mitsumi YD0103
- CR1 39.130 MHz
- CR2 10.245 MHz

DESIGN NOTES

Voltage Regulator and Battery Checker

The external regulator output voltage $V_{EXTREGOUT}$ on EXTREGOUT is determined by the resistor divider network between EXTREGADJ, EXTREGOUT and GND.

The battery checker turns ON when the voltage on EXTERGOUT reaches the threshold voltage, shown as V_A in figure 1, and when the supply voltage is $V_A + 0.3$ V. Hysteresis is fixed at 100 mV.

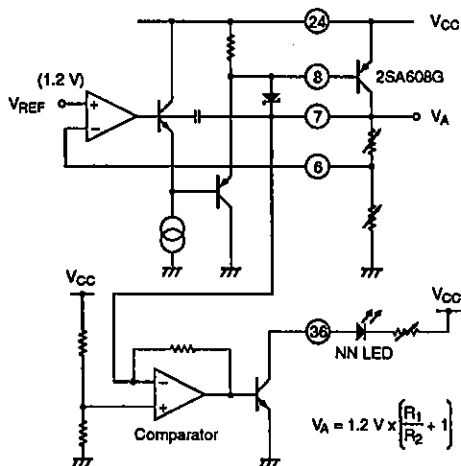

Figure 1. Battery checker threshold

ALC Detector

When ALCDET is tied LOW as shown in figure 2, the ALC circuitry becomes a limiter. When ALCDET is not tied LOW, the ALC detector functions normally and an external RC network should be connected to ALCDET as shown in figure 3.



Figure 2. Limiter-mode connection

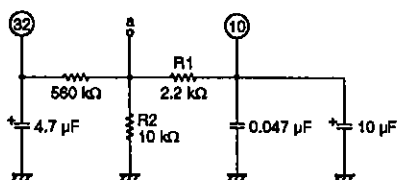

Figure 3. ALC-mode connection

Note

The ALC time constant resistors, R1 and R2, should be chosen such that the potential at point a is approxi-

mately 1.00 V for an input level below the ALC threshold, and the output current from VREF1 is 300 μA or lower.

Highpass Filter

The highpass cutoff point of the highpass filter is determined by the RC network formed by the internal resistor R_H and an external capacitor.

Lowpass Filter

The lowpass cutoff point of the lowpass filter is determined by the RC network formed by the internal resistor R_L and an external capacitor.

First IF Oscillator

An external crystal, inductor and capacitor should be connected to 1STOSC1 and 1STOSC2.

Second IF Oscillator

An external crystal and capacitor should be connected to 2NDOSC1 and 2NDOSC2 to form a Colpitts oscillator.

VCO

The oscillator frequency is determined by the value of an internal varactor. The varactor value is controlled by the level on FROMPLL.

Power Amplifier

PWRCONT is used to reduce power consumption by decoupling the bias currents that normally flow into the power amplifier inputs. PWRCONT is HIGH during normal operation and LOW during the power mute and battery save modes.

IF Amplifier

To ensure the correct biasing of the IF amplifier inputs, a bias resistor should be connected between IFIN and VREF1.

Signal Meter Output

The voltage on the signal meter output is 0.7 V, with an external 16 kΩ resistor and 1 μF capacitor connected. This output voltage, however, is temperature dependent. The output voltage can be compensated by a level shift using either an external diode, as shown in figure 4, or transistor. This circuit uses the temperature dependence of resistor R_A to compensate for the signal meter output voltage.

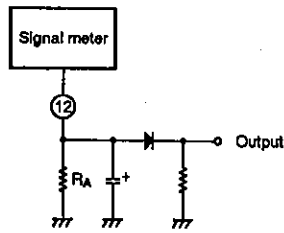

Figure 4. Compensation network

The affect of the level shift compensation is shown in figure 5, and the corresponding temperature coefficients, in figure 6.

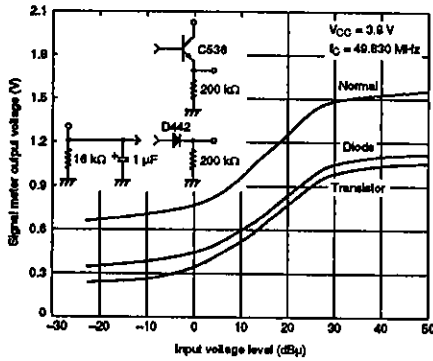

Figure 5. Signal meter output voltage vs. input voltage

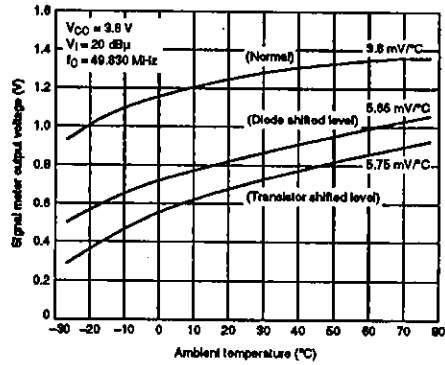

Figure 6. Signal meter output voltage vs. ambient temperature

Noise Detector

The noise component of the FM modulator output, after it has been amplified and detected, is input to a Schmitt-trigger circuit which has hysteresis. A noise

component of approximately 0.5 to 1 V on NOISEOUT will activate the noise detector, depending on the Schmitt-trigger levels.

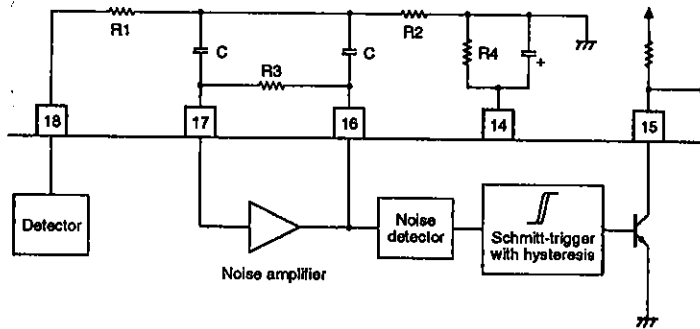

Figure 7. Noise detector circuit

The random noise level varies when a front end or filter is connected. Accordingly, the Schmitt-trigger levels will need to be checked after making such a connection. The Schmitt-trigger level on the weak input side is adjusted by reducing the resistance of R4 or by reducing the noise amplifier gain.

The bandpass noise amplifier gain, G_o , the center frequency, f_c , and the quality factor, Q , are determined from the following equations, respectively.

$$G_o = \frac{1}{2} \times \frac{R3}{R1}$$

$$f_c = \frac{1}{2\pi C} \times \sqrt{\frac{R1 + R2}{R1 \times R2 \times R3}}$$

$$Q = \frac{1}{2} \times \sqrt{\frac{R1 + R2}{R1 \times R2} \times R3}$$

TYPICAL APPLICATIONS

Fixed Station Frequency Operation

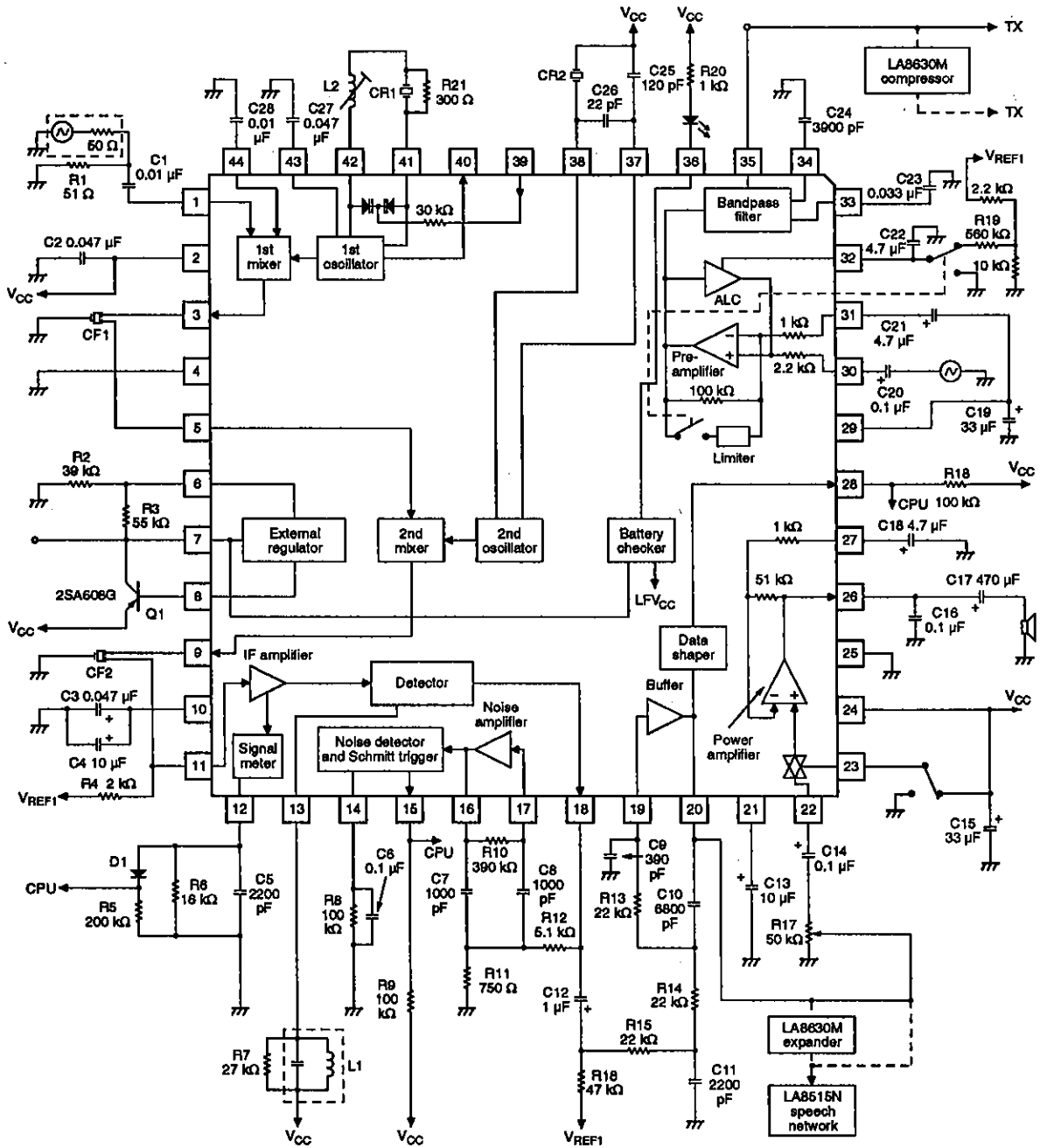

- CF1 Murata SFE10.7MS2
- CF2 Murata CFU455E2
- L1 Mitsumi WK40337
- L2 Mitsumi YD0103
- CR1 39.130 MHz
- CR2 10.245 MHz

LA8606M

Operation with an External PLL

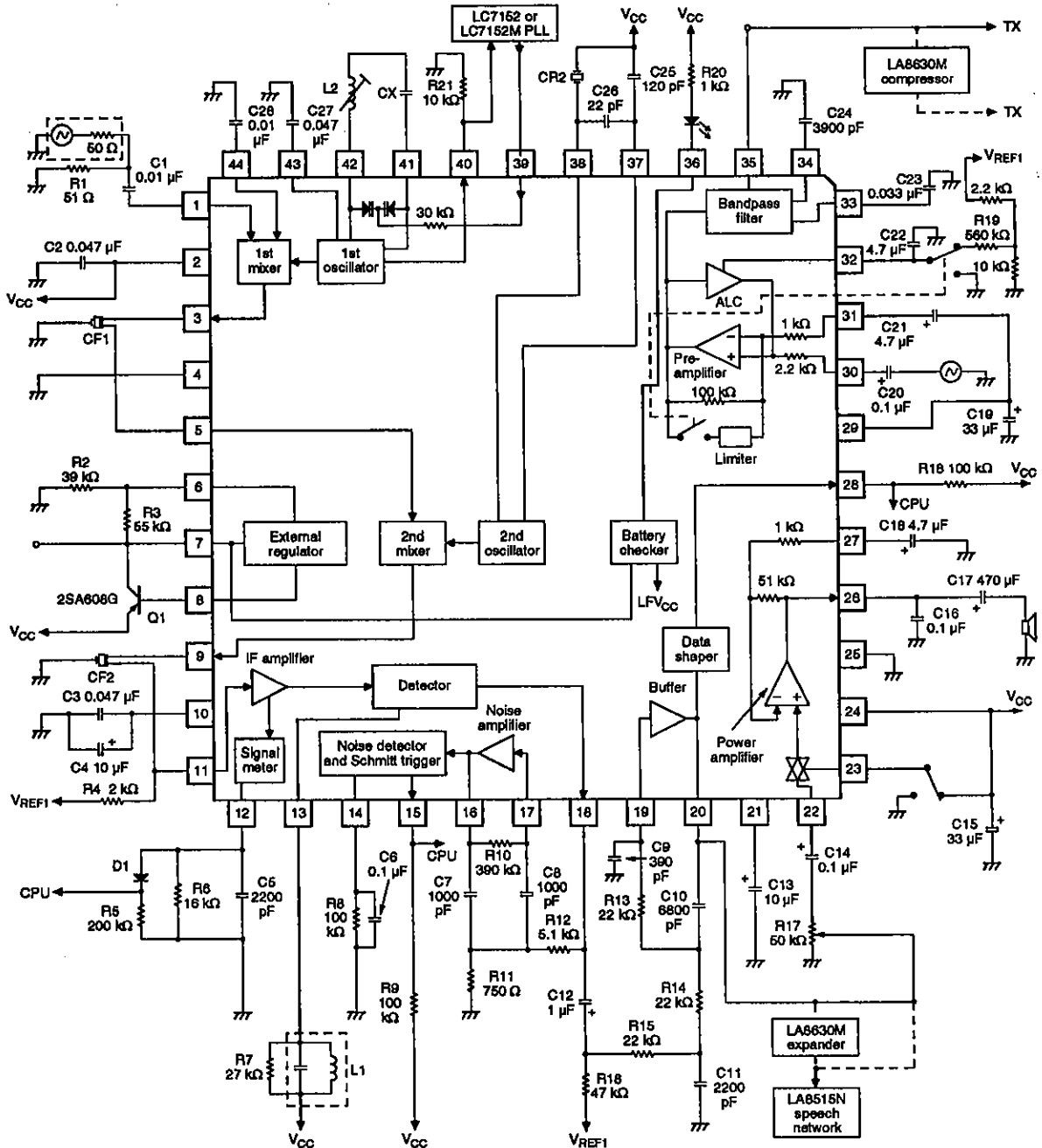

- CF1 Murata SFE10.7MS2
- CF2 Murata CFU455E2
- L1 Mitsumi WK40337
- CR2 10.245 MHz
- When $f_{vco1} = 36$ MHz,
- CX 18 pF
- L2 Mitsumi YD1001
- When $f_{vco2} = 39$ MHz,
- CX 18 pF
- L2 Mitsumi YD1002

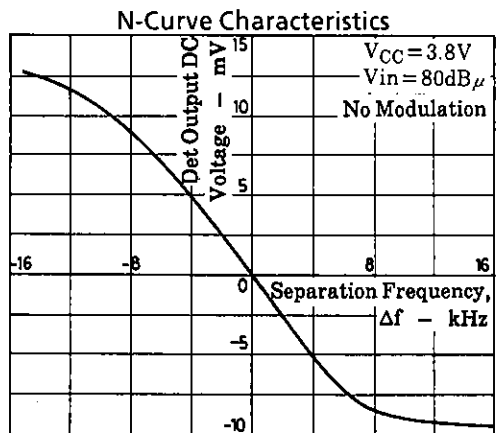
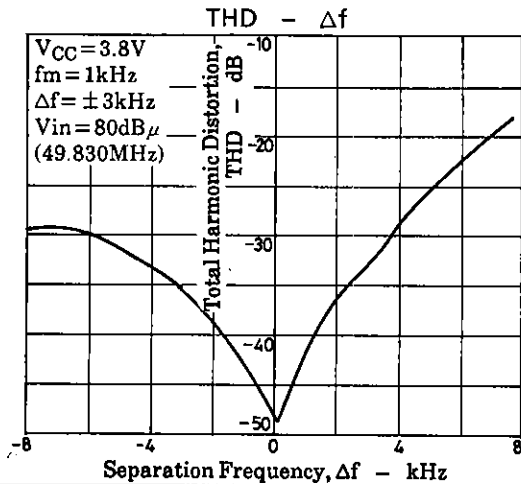
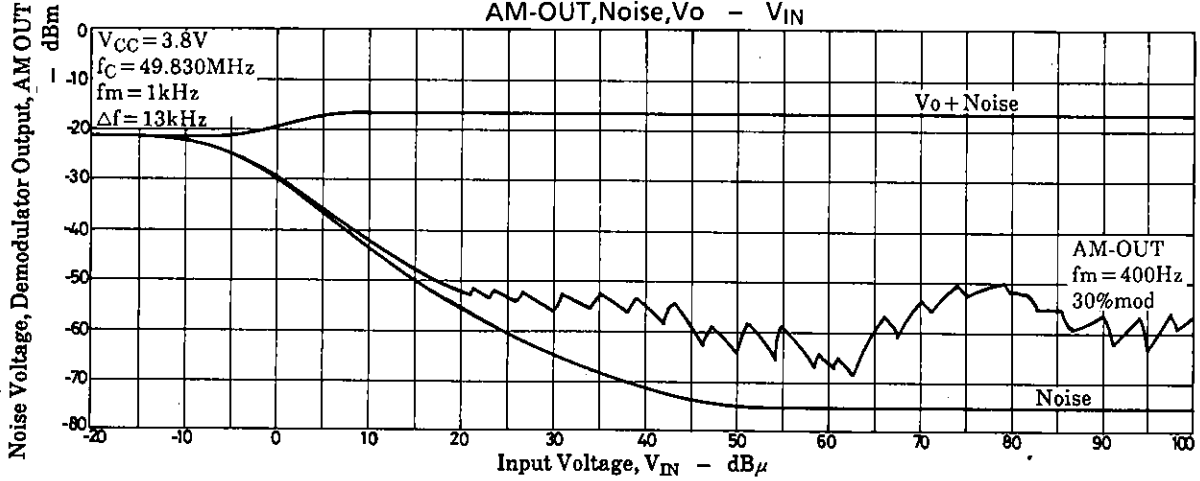
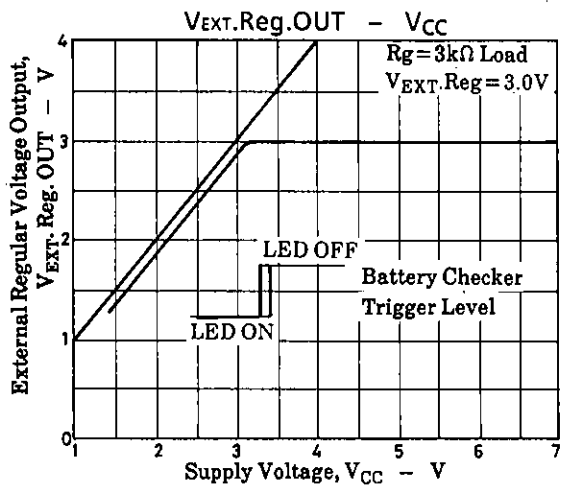
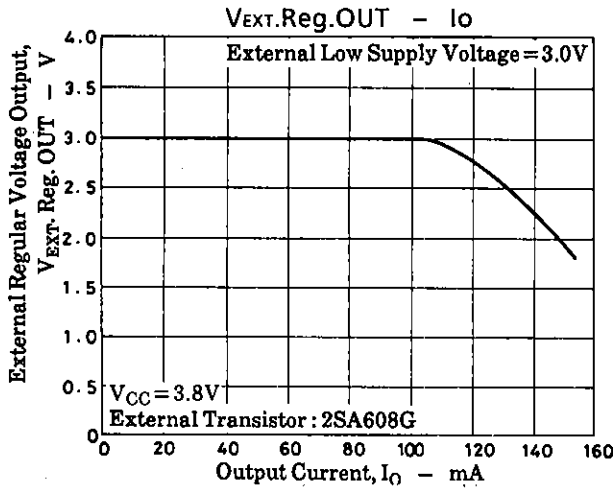
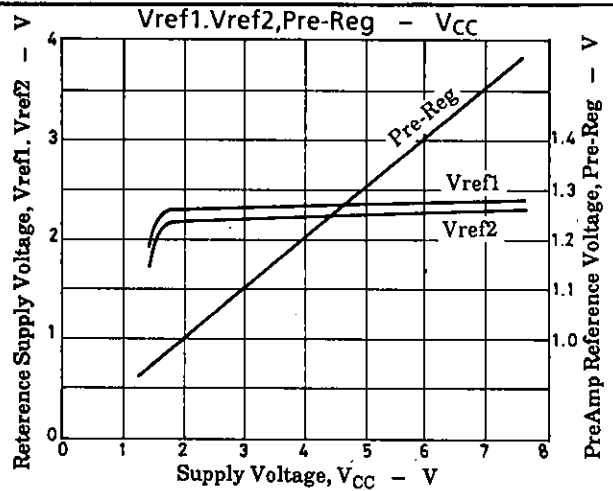
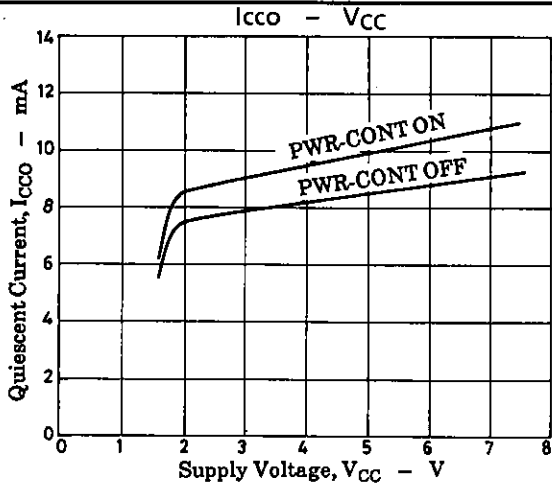

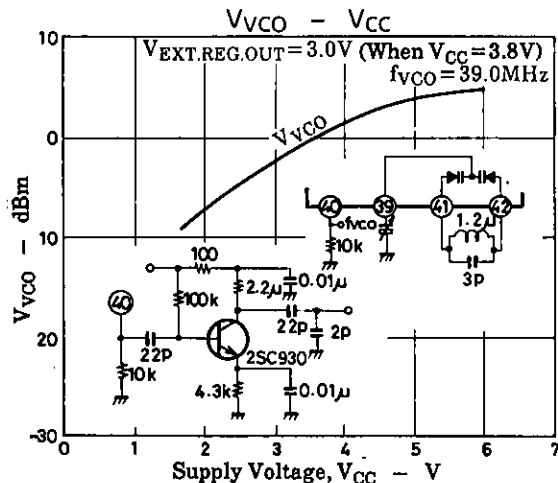
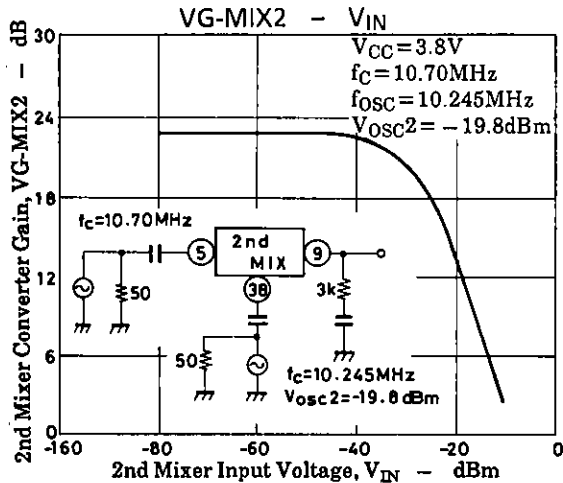
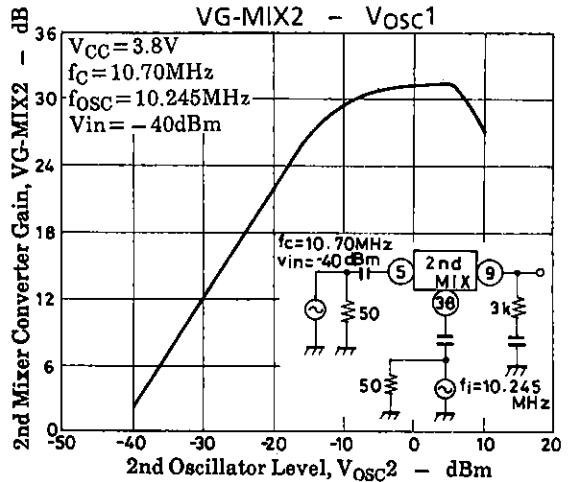
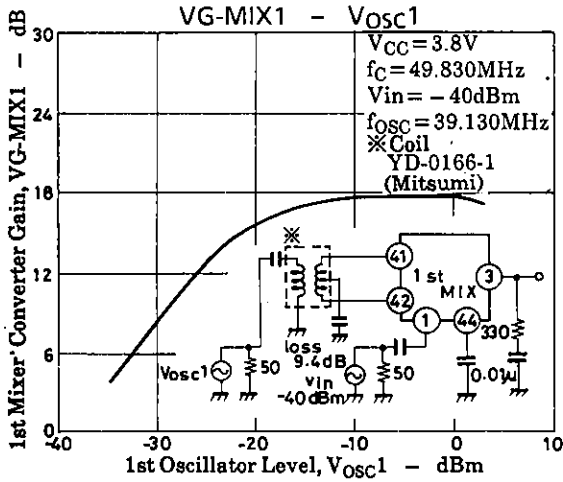
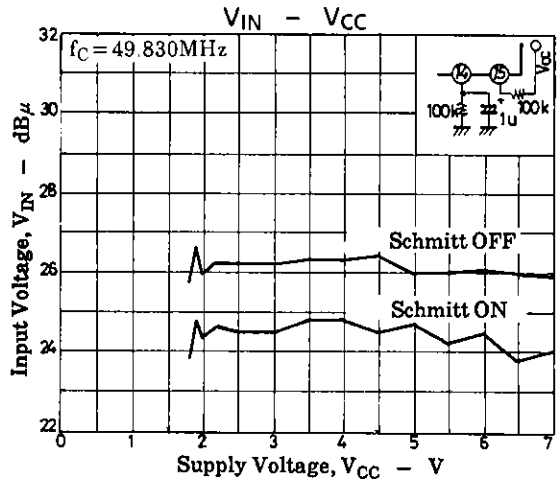
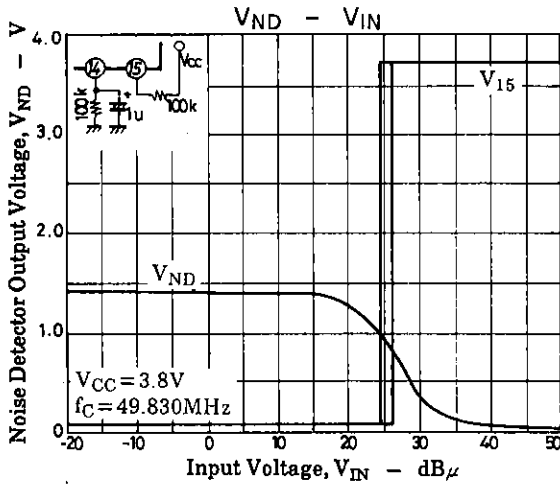
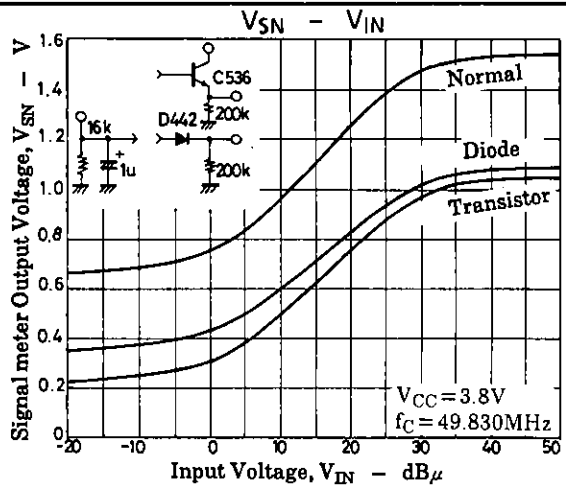
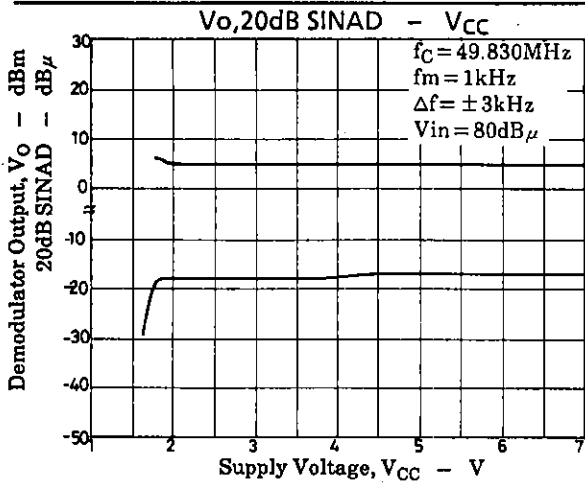

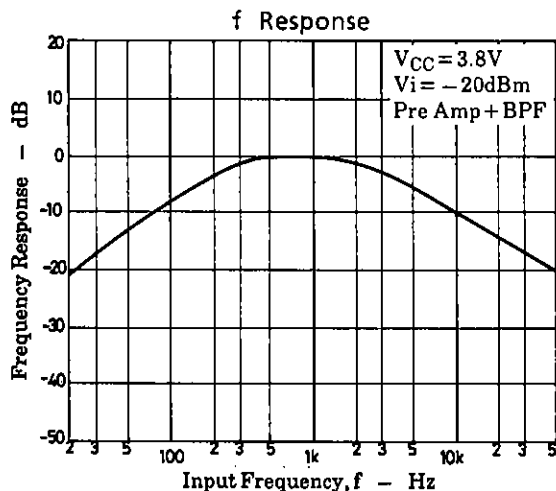
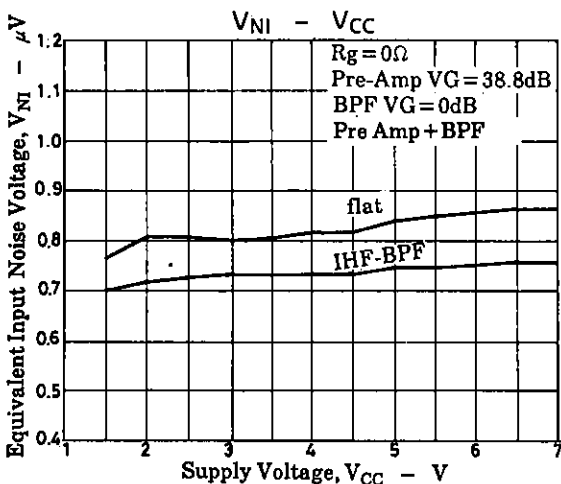
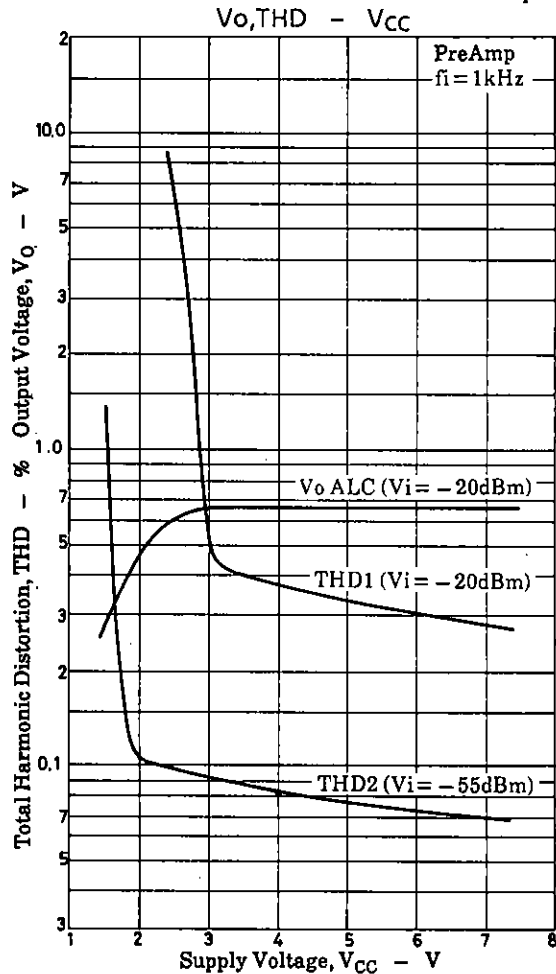
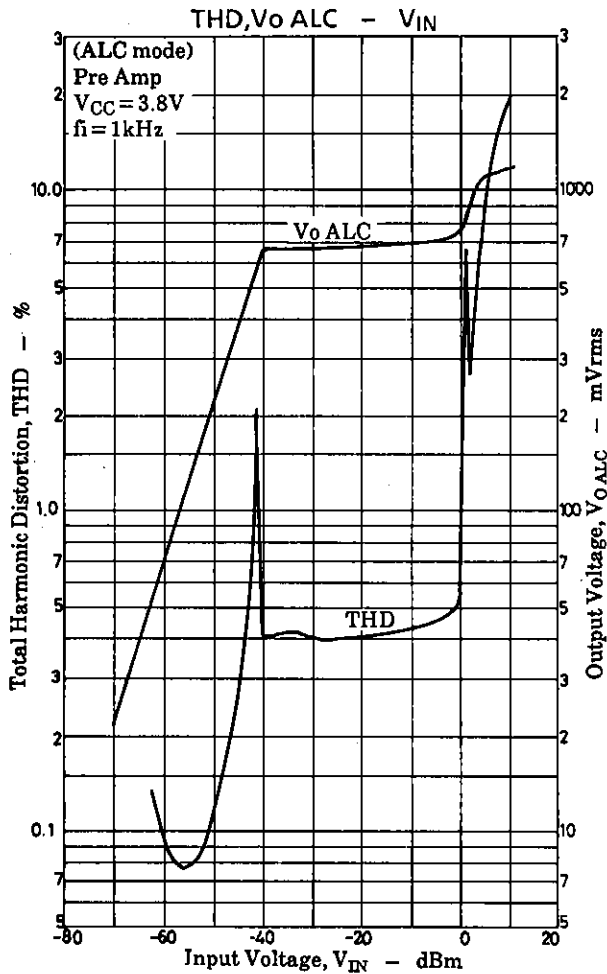
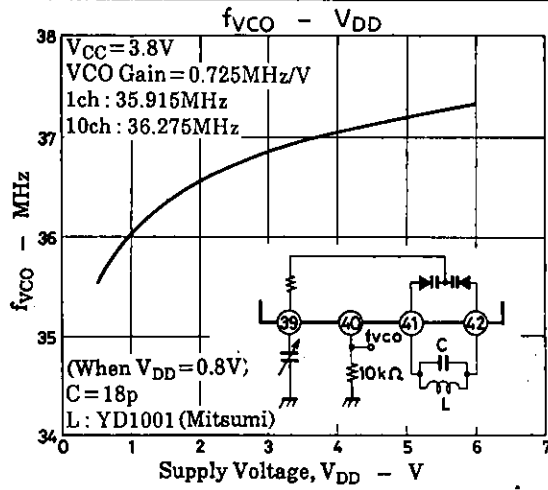
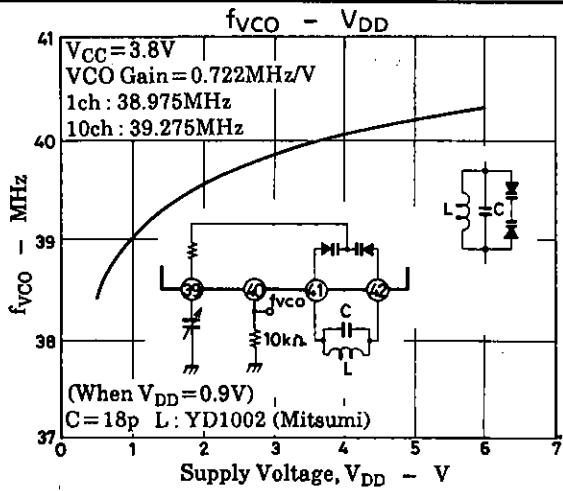

LA8606M

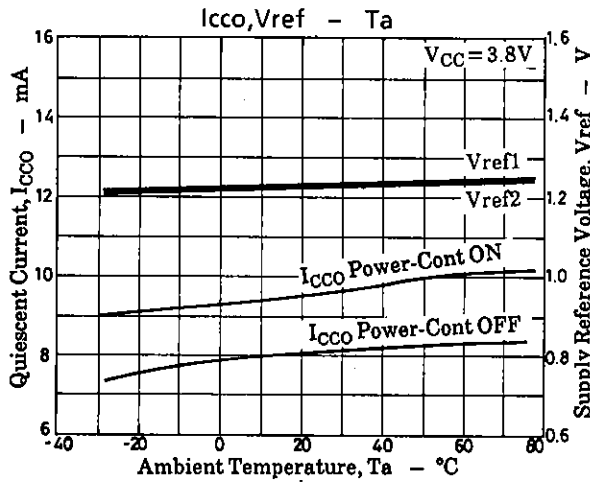
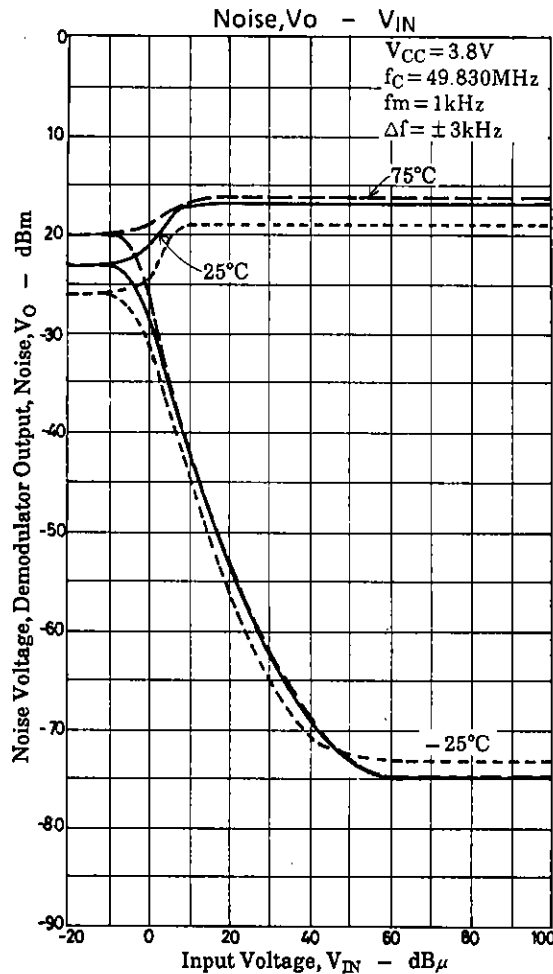
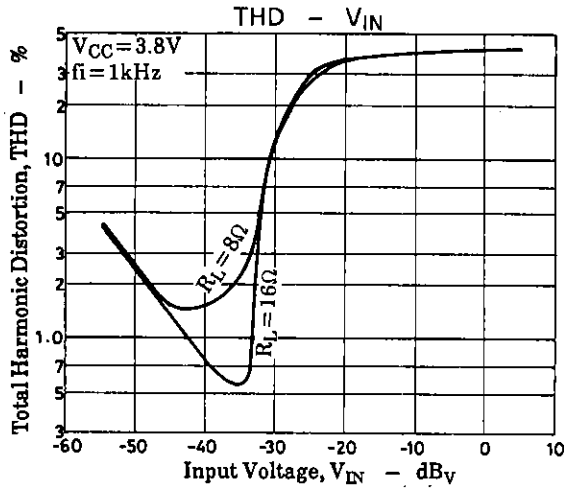
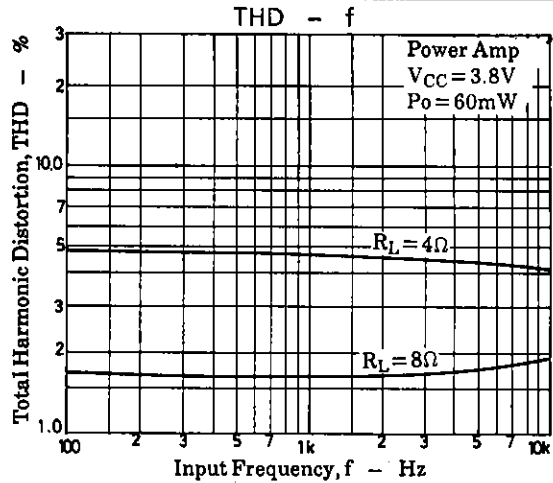
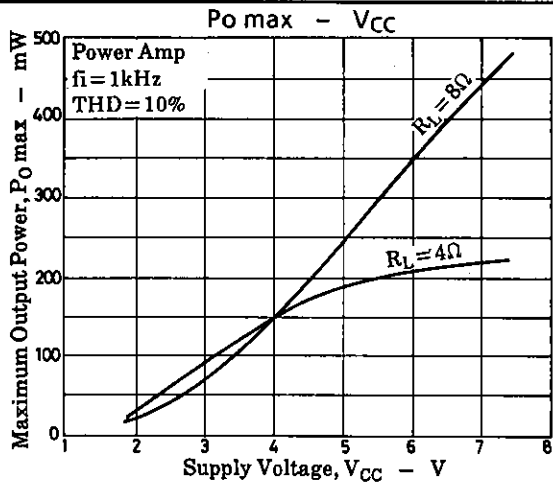

■ No products described or contained herein are intended for use in surgical implants, life-support systems, aerospace equipment, nuclear power control systems, vehicles, disaster/crime-prevention equipment and the like, the failure of which may directly or indirectly cause injury, death or property loss.

■ Anyone purchasing any products described or contained herein for an above-mentioned use shall:

- ① Accept full responsibility and indemnify and defend SANYO ELECTRIC CO., LTD., its affiliates, subsidiaries and distributors and all their officers and employees, jointly and severally, against any and all claims and litigation and all damages, cost and expenses associated with such use;
- ② Not impose any responsibility for any fault or negligence which may be cited in any such claim or litigation on SANYO ELECTRIC CO., LTD., its affiliates, subsidiaries and distributors or any of their officers and employees jointly or severally.

■ Information (including circuit diagrams and circuit parameters) herein is for example only; it is not guaranteed for volume production. SANYO believes information herein is accurate and reliable, but no guarantees are made or implied regarding its use or any infringements of intellectual property rights or other rights of third parties.

LA8606M

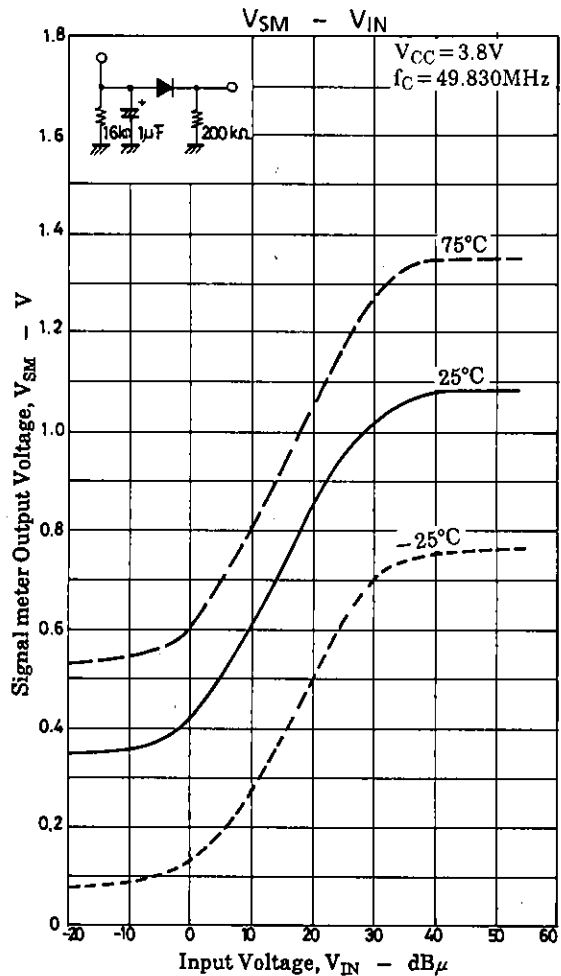
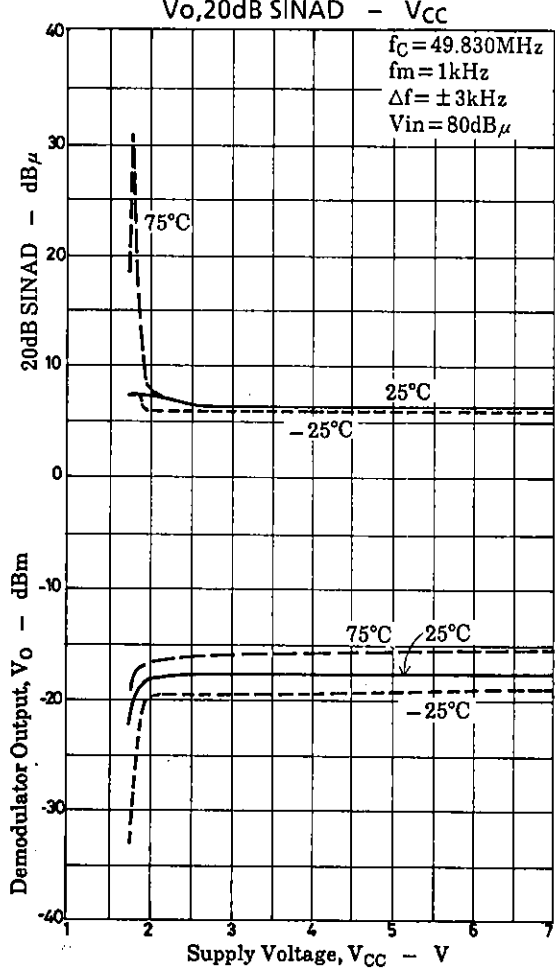
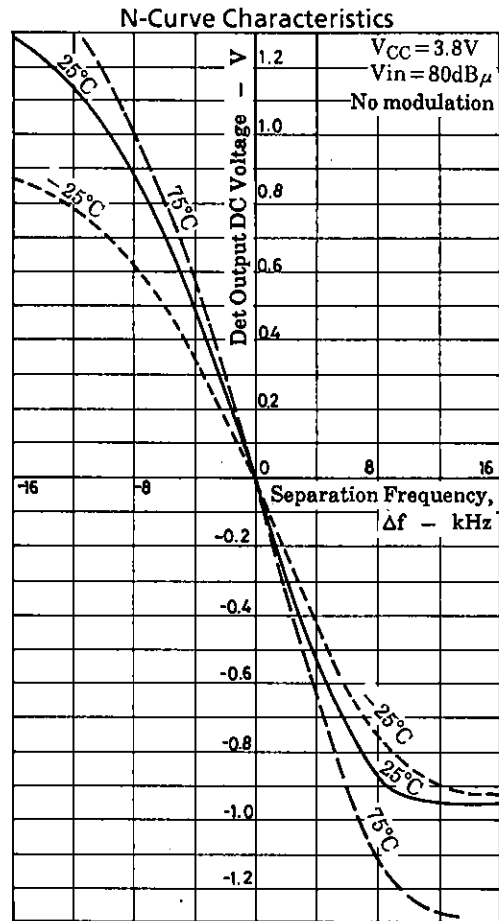
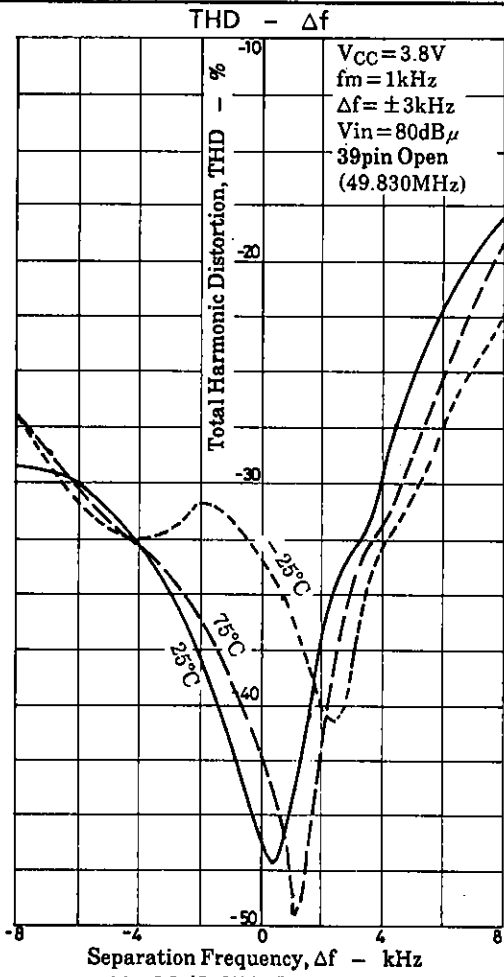

LA8606M

