

Infrared LED

L5276, L5586, L6286

Subminiature LED

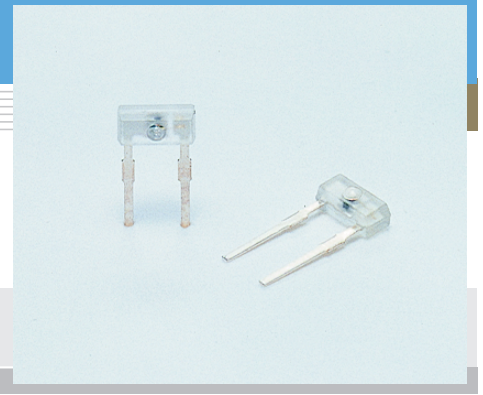

L5276, L5586 and L6286 are infrared LED molded into a subminiature, clear plastic package.

Features

- Peak emission wavelength
L5276 : 880 nm
L5586, L6286: 940 nm
- L6286: High output power
- Subminiature plastic package with lens

Applications

- Optical switches
- Cameras
- Encoders

■ Absolute maximum ratings (Ta=25 °C)

Parameter	Symbol	Condition	Value	Unit
Forward current	IF		50	mA
Reverse voltage	VR		5	V
Pulse forward current	IFP	Pulse width: 100 μs Duty ratio: 1 %	0.5	A
Power dissipation	Po		80	mW
Operating temperature	Topr		-25 to +85	°C
Storage temperature	Tstg		-30 to +85	°C
Soldering	-		260 °C, 3 s at least 2.5 mm away from package surface	-

■ Electrical and optical characteristics (Ta=25 °C)

Parameter	Symbol	Condition	L5276			L5586			L6286			Unit
			Min.	Typ.	Max.	Min.	Typ.	Max.	Min.	Typ.	Max.	
Peak emission wavelength	λ_p	IF=20 mA	-	880	-	-	940	-	-	940	-	nm
Spectral half width	$\Delta\lambda$	IF=20 mA	-	50	-	-	45	-	-	45	-	nm
Forward voltage	VF	IF=20 mA	-	1.3	1.6	-	1.25	1.45	-	1.25	1.45	V
Reverse current	IR	VR=5 V	-	-	10	-	-	10	-	-	10	μA
Radiant flux	ϕ_e	IF=20 mA	1.0	2.2	-	0.5	-	-	0.8	-	-	mW
Terminal capacitance	Ct	VR=0 V, f=1 MHz	-	30	-	-	20	-	-	20	-	pF

Directivity

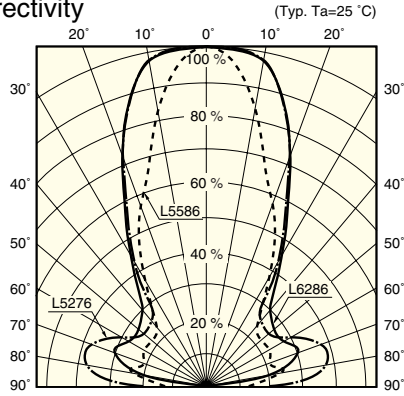

RELATIVE RADIANT OUTPUT

KLEDB0108EA

Radiant output vs. ambient temperature

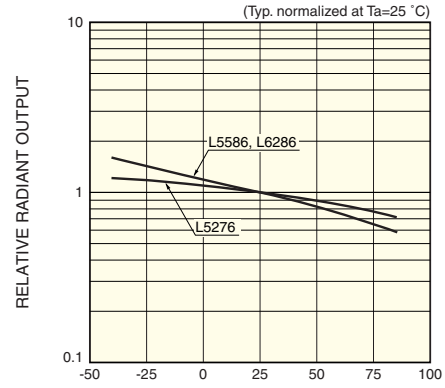

AMBIENT TEMPERATURE ($^\circ\text{C}$)

KLEDB0109EA

Allowable forward current vs. ambient temperature

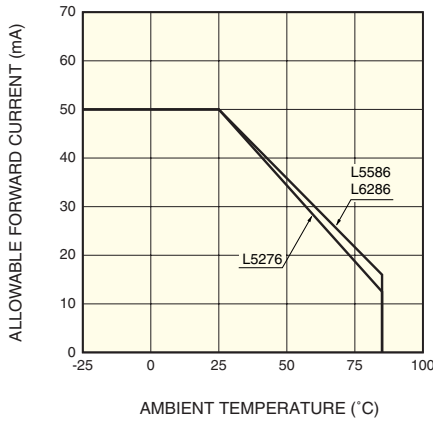

AMBIENT TEMPERATURE ($^\circ\text{C}$)

KLEDB0110EA

Pulse forward current vs. duty ratio

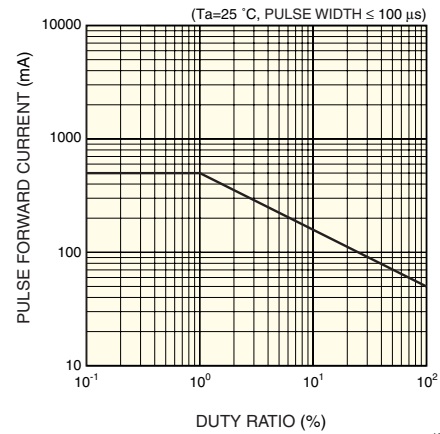

DUTY RATIO (%)

KLEDB0111EA

Dimensional outline (unit: mm)

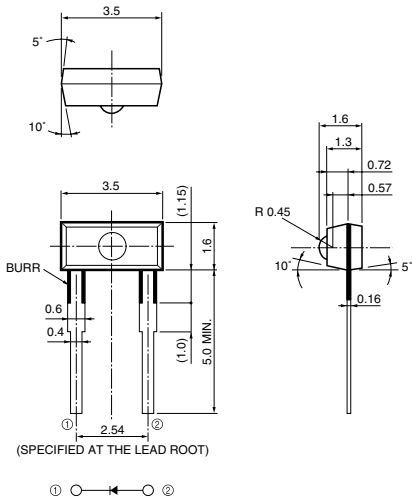

(SPECIFIED AT THE LEAD ROOT)

① ○ ← ○ ②

Shaded area indicates burr.
Tolerance unless otherwise noted: $\pm 0.2, \pm 2$
Values in parentheses are not guaranteed,
but for reference.

KLEDA0023EA

HAMAMATSU

Information furnished by HAMAMATSU is believed to be reliable. However, no responsibility is assumed for possible inaccuracies or omissions. Specifications are subject to change without notice. No patent rights are granted to any of the circuits described herein. ©2001 Hamamatsu Photonics K.K.

HAMAMATSU PHOTONICS K.K., Solid State Division

1126-1 Ichino-cho, Hamamatsu City, 435-8558 Japan, Telephone: (81) 053-434-3311, Fax: (81) 053-434-5184, <http://www.hamamatsu.com>

U.S.A.: Hamamatsu Corporation: 360 Foothill Road, P.O.Box 6910, Bridgewater, N.J. 08807-0910, U.S.A., Telephone: (1) 908-231-0960, Fax: (1) 908-231-1218

Germany: Hamamatsu Photonics Deutschland GmbH: Arzbergerstr. 10, D-82211 Herrsching am Ammersee, Germany, Telephone: (49) 08152-3750, Fax: (49) 08152-2658

France: Hamamatsu Photonics France S.A.R.L.: 8, Rue du Saule Trapu, Parc du Moulin de Massy, 91882 Massy Cedex, France, Telephone: 33-(1) 69 53 71 10, Fax: 33-(1) 69 53 71 10

United Kingdom: Hamamatsu Photonics UK Limited: 2 Howard Court, 10 Twin Road, Welwyn Garden City, Hertfordshire AL7 1BW, United Kingdom, Telephone: (44) 1707-294888, Fax: (44) 1707-325777

North Europe: Hamamatsu Photonics Norden AB: Smidesvägen 12, SE-171 41 Solna, Sweden, Telephone: (46) 8-509-031-00, Fax: (46) 8-509-031-01

Italy: Hamamatsu Photonics Italia S.R.L.: Strada della Moia, 1/E, 20020 Arese, (Milano), Italy, Telephone: (39) 02-935-81-733, Fax: (39) 02-935-81-741