

Infrared LED

L4100

Resin-potted metal package LED



Features

- High reliability
- High output power

Applications

- Auto focus
- Optical switches
- Auto control equipment

■ Absolute maximum ratings (Ta=25 °C)

Parameter	Symbol	Condition	Value	Unit
Forward current	I _F		70	mA
Reverse voltage	V _R		5	V
Pulse forward current	I _{FP}	Pulse width=10 μs Duty ratio=1 %	0.8	A
Operating temperature	T _{opr}		-30 to +85	°C
Storage temperature	T _{stg}		-40 to +100 *	°C

* Guaranteed to resist temperature cycle test of up to 5 cycles

■ Electrical and optical characteristics (Ta=25 °C)

Parameter	Symbol	Condition	Min.	Typ.	Max.	Unit
Peak emission wavelength	λ _p	I _F =50 mA	870	890	920	nm
Spectral half width	Δλ	I _F =50 mA	-	50	-	nm
Forward voltage	V _F	I _F =50 mA	-	1.45	1.60	V
Pulse forward voltage	V _{FP}	I _F =0.8 A	-	3	3.7	V
Reverse current	I _R	V _R =5 V	-	-	5	μA
Radiant flux	φ _e	I _F =50 mA	12	14	-	mW
Radiant illuminance	P _E	I _F =50 mA	-	1.3	-	mW/cm ²
Rise time	t _r	I _F =50 mA	-	0.45	0.7	μs
Fall time	t _f	I _F =50 mA	-	0.45	0.7	μs

■ Emission spectrum

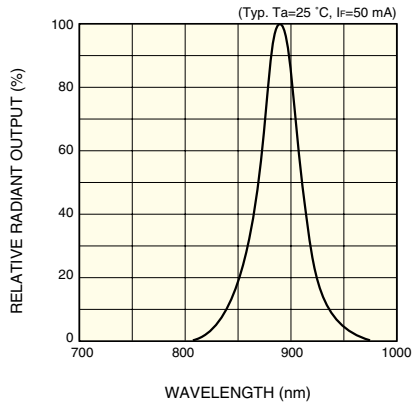

KLEDB0117EB

■ Radiant flux vs. forward current

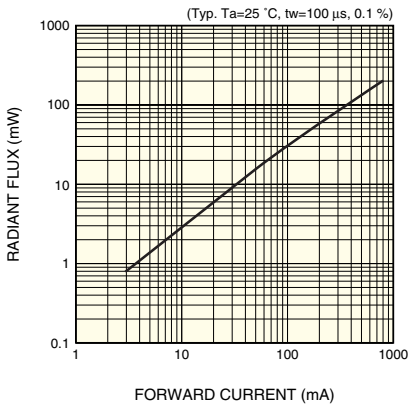

KLEDB0177EA

■ Forward current vs. forward voltage

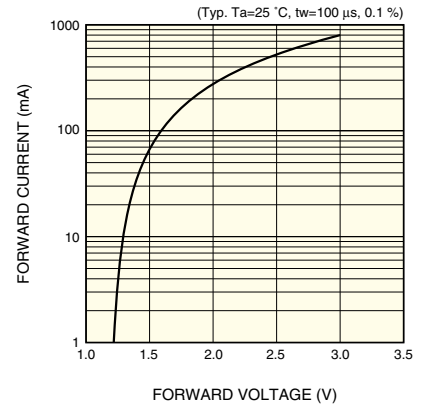

KLEDB0178EA

■ Directivity

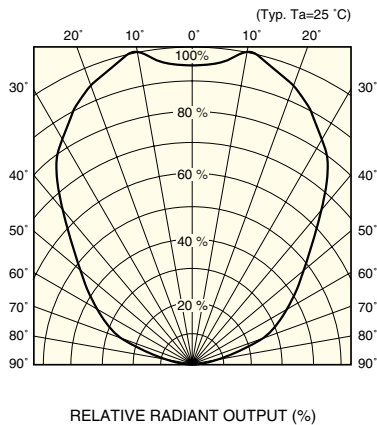

KLEDB0179EA

■ Radiant output vs. ambient temperature

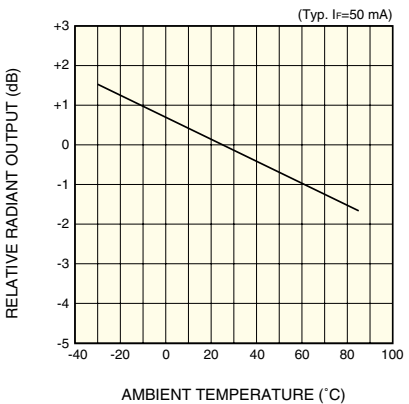

KLEDB0145EA

■ Forward voltage vs. ambient temperature

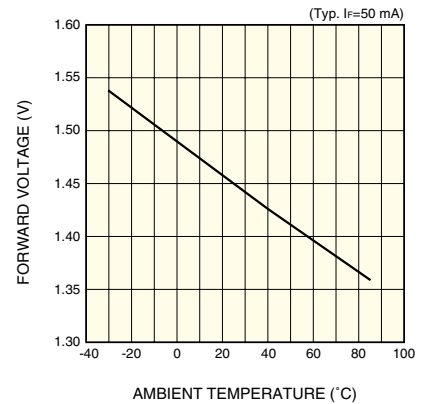

KLEDB0180EA

■ Allowable forward current vs. ambient temperature

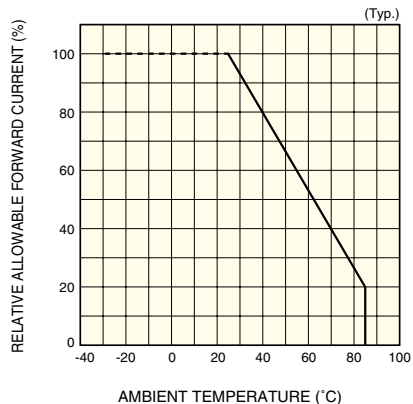

KLEDB0027EB

■ Allowable forward current vs. duty ratio

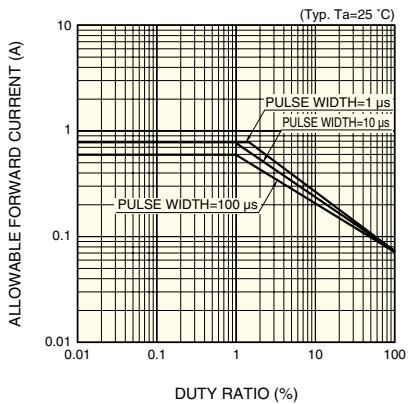

KLEDB0037EB

■ Dimensional outline (unit: mm)

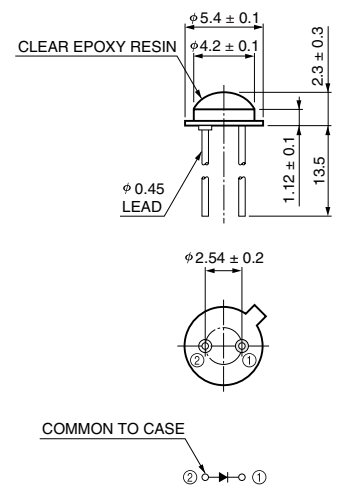

KLEDA0009ED

HAMAMATSU

HAMAMATSU PHOTONICS K.K., Solid State Division

1126-1 Ichino-cho, Hamamatsu City, 435-8558 Japan, Telephone: (81) 053-434-3311, Fax: (81) 053-434-5184, <http://www.hamamatsu.com>

U.S.A.: Hamamatsu Corporation: 360 Foothill Road, P.O.Box 6910, Bridgewater, N.J. 08807-0910, U.S.A., Telephone: (1) 908-231-0960, Fax: (1) 908-231-1218

Germany: Hamamatsu Photonics Deutschland GmbH: Arzbergerstr. 10, D-82211 Herrsching am Ammersee, Germany, Telephone: (49) 08152-3750, Fax: (49) 08152-2658

France: Hamamatsu Photonics France S.A.R.L.: 8, Rue du Saule Trapu, Parc du Moulin de Massy, 91882 Massy Cedex, France, Telephone: 33-(1) 69 53 71 00, Fax: 33-(1) 69 53 71 10

United Kingdom: Hamamatsu Photonics UK Limited: 2 Howard Court, 10 Tewin Road, Welwyn Garden City, Hertfordshire AL7 1BW, United Kingdom, Telephone: (44) 1707-294888, Fax: (44) 1707-325777

North Europe: Hamamatsu Photonics Norden AB: Smidesvägen 12, SE-171 41 Solna, Sweden, Telephone: (46) 8-509-031-00, Fax: (46) 8-509-031-01

Italy: Hamamatsu Photonics Italia S.R.L.: Strada della Moia, 1/E, 20020 Arese, (Milano), Italy, Telephone: (39) 02-935-81-733, Fax: (39) 02-935-81-741

Information furnished by HAMAMATSU is believed to be reliable. However, no responsibility is assumed for possible inaccuracies or omissions. Specifications are subject to change without notice. No patent rights are granted to any of the circuits described herein. ©2001 Hamamatsu Photonics K.K.