



L4100

## Resin-potted metal package LED

### Features

- High reliability
- High output power

### Applications

- Optical switches
- Auto control equipment

### Absolute maximum ratings (Ta=25 °C)

Parameter	Symbol	Condition	Value	Unit
Forward current	IF		70	mA
Reverse voltage	VR		3	V
Pulse forward current	IFP	Pulse width=10 μs Duty ratio=1%	0.8	A
Operating temperature	Topr		-30 to +85	°C
Storage temperature	Tstg		-40 to +100*	°C

\* Guaranteed to resist temperature cycle test of up to 5 cycles

Note: Exceeding the absolute maximum ratings even momentarily may cause a drop in product quality. Always be sure to use the product within the absolute maximum ratings.

### Electrical and optical characteristics (Ta=25 °C)

Parameter	Symbol	Condition	Min.	Typ.	Max.	Unit
Peak emission wavelength	$\lambda_p$	IF=50 mA	870	890	920	nm
Spectral half width	$\Delta\lambda$	IF=50 mA	-	50	-	nm
Forward voltage	VF	IF=50 mA	-	1.45	1.60	V
Pulse forward voltage	VFP	IF=0.8 A	-	3	3.7	V
Reverse current	IR	VR=5 V	-	-	5	μA
Radiant flux	$\phi_e$	IF=50 mA	12	14	-	mW
Radiant illuminance	PE	IF=50 mA	-	1.3	-	mW/cm <sup>2</sup>
Rise time	tr	IF=50 mA	-	0.45	0.7	μs
Fall time	tf	IF=50 mA	-	0.45	0.7	μs

**Emission spectrum**

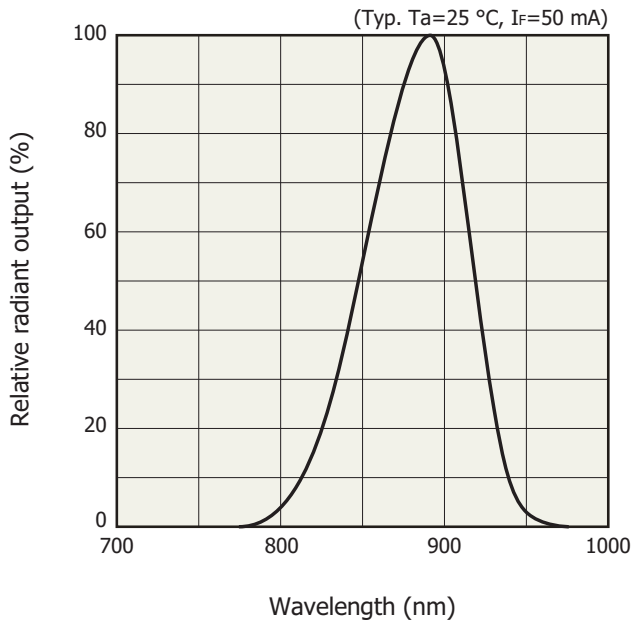

**Radiant flux vs. forward current**

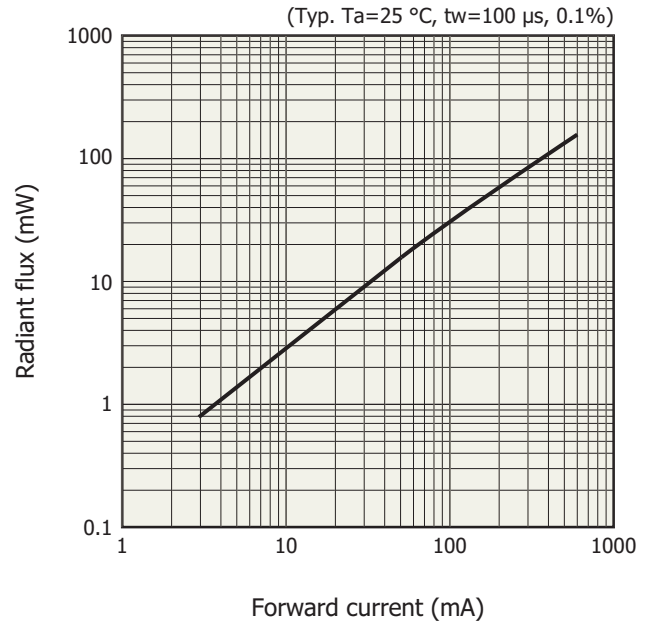

**Forward current vs. forward voltage**

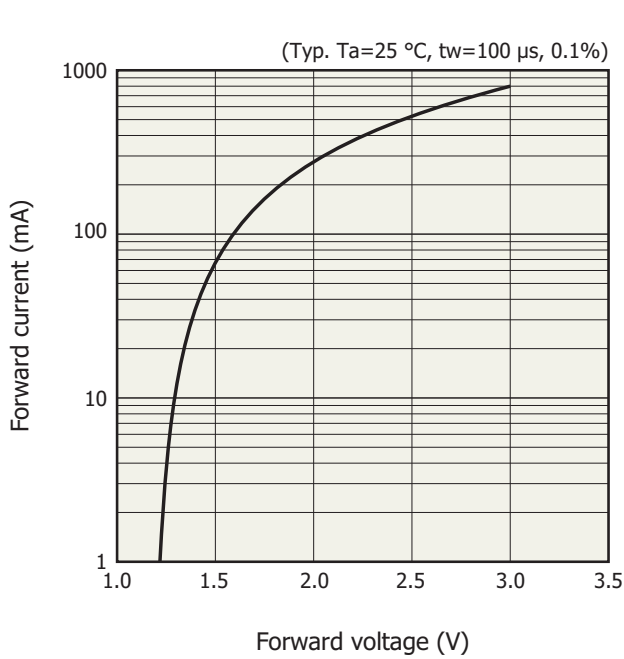

**Directivity**

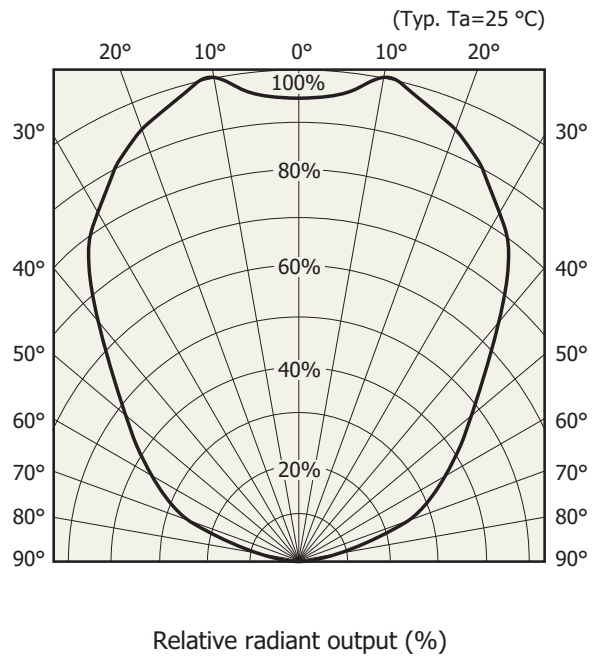

**Radiant output vs. ambient temperature**

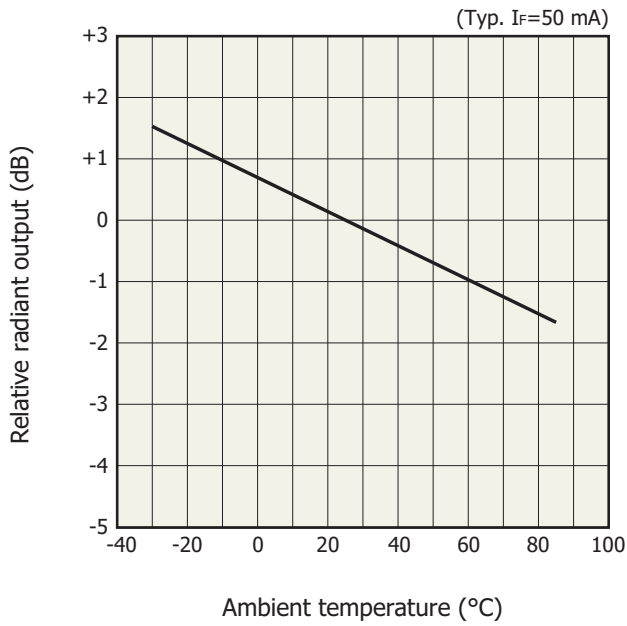

**Forward voltage vs. ambient temperature**

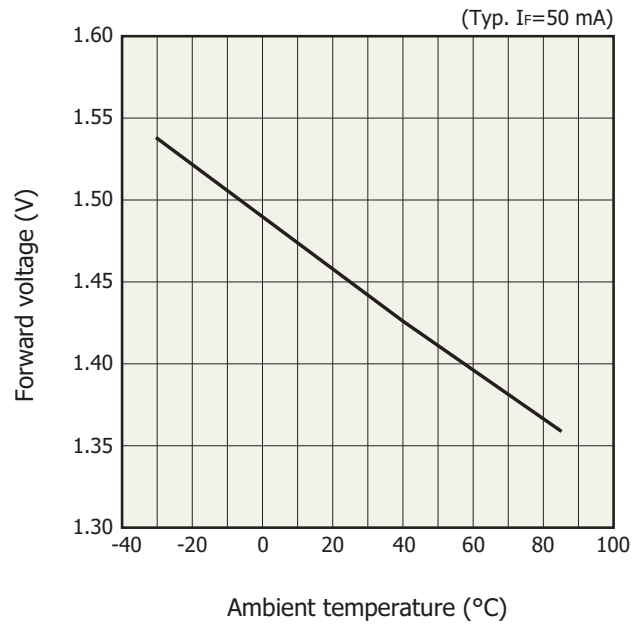

**Allowable forward current vs. ambient temperature**

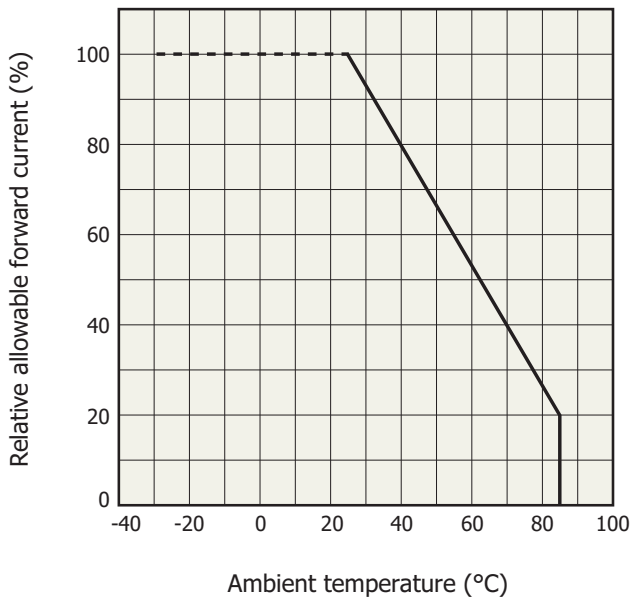

**Allowable forward current vs. duty ratio**

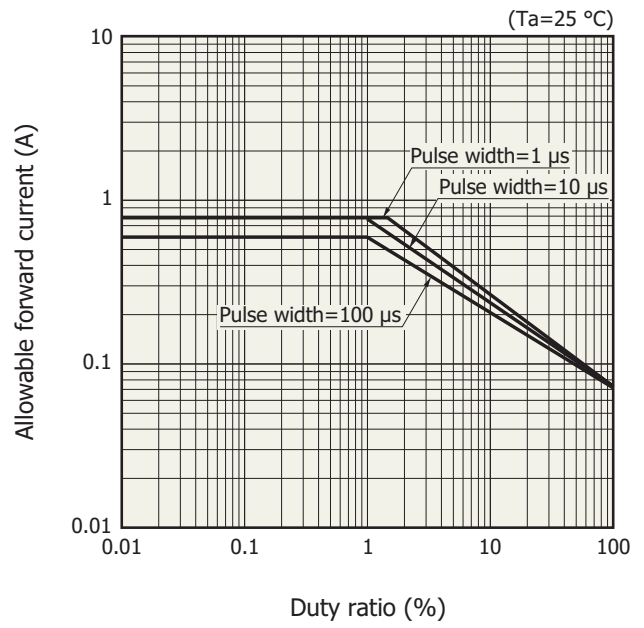

### Dimensional outline (unit: mm)

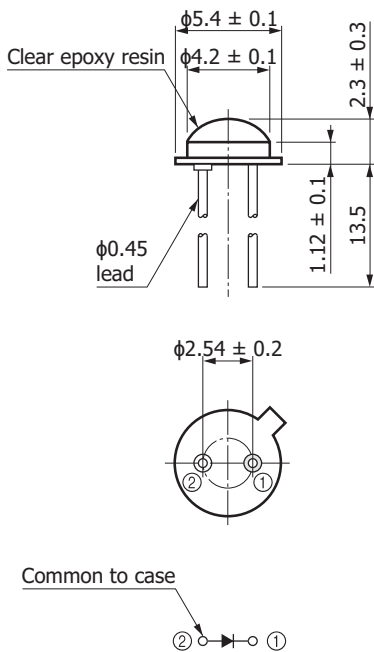

### Related information

[www.hamamatsu.com/sp/ssd/doc\\_en.html](http://www.hamamatsu.com/sp/ssd/doc_en.html)

#### Precautions

- Disclaimer
- Metal, ceramic, plastic products

Information described in this material is current as of November, 2015.

Product specifications are subject to change without prior notice due to improvements or other reasons. This document has been carefully prepared and the information contained is believed to be accurate. In rare cases, however, there may be inaccuracies such as text errors. Before using these products, always contact us for the delivery specification sheet to check the latest specifications.

The product warranty is valid for one year after delivery and is limited to product repair or replacement for defects discovered and reported to us within that one year period. However, even if within the warranty period we accept absolutely no liability for any loss caused by natural disasters or improper product use. Copying or reprinting the contents described in this material in whole or in part is prohibited without our prior permission.

# HAMAMATSU

[www.hamamatsu.com](http://www.hamamatsu.com)

HAMAMATSU PHOTONICS K.K., Solid State Division

1126-1 Ichino-cho, Higashi-ku, Hamamatsu City, 435-8558 Japan, Telephone: (81) 53-434-3311, Fax: (81) 53-434-5184

U.S.A.: Hamamatsu Corporation: 360 Foothill Road, Bridgewater, N.J. 08807, U.S.A., Telephone: (1) 908-231-0960, Fax: (1) 908-231-1218

Germany: Hamamatsu Photonics Deutschland GmbH: Arzbergerstr. 10, D-82211 Herrsching am Ammersee, Germany, Telephone: (49) 8152-375-0, Fax: (49) 8152-265-8

France: Hamamatsu Photonics France S.A.R.L.: 19, Rue du Saule Trapu, Parc du Moulin de Massy, 91882 Massy Cedex, France, Telephone: 33-(1) 69 53 71 00, Fax: 33-(1) 69 53 71 10

United Kingdom: Hamamatsu Photonics UK Limited: 2 Howard Court, 10 Tewin Road, Welwyn Garden City, Hertfordshire AL7 1BW, United Kingdom, Telephone: (44) 1707-294888, Fax: (44) 1707-325777

North Europe: Hamamatsu Photonics Norden AB: Torshamnsgatan 35 16440 Kista, Sweden, Telephone: (46) 8-509-031-00, Fax: (46) 8-509-031-01

Italy: Hamamatsu Photonics Italia S.r.l.: Strada della Moia, 1 int. 6, 20020 Arese (Milano), Italy, Telephone: (39) 02-93581733, Fax: (39) 02-93581741

China: Hamamatsu Photonics (China) Co., Ltd.: B1201, Jiaming Center, No.27 Dongsanhuan Beilu, Chaoyang District, Beijing 100020, China, Telephone: (86) 10-6586-6006, Fax: (86) 10-6586-2866