

KS310-IMX6



Features

- 10.1" TFT Touch Screen Panel PC
- 2GB DDR3 memory down
- 4GB eMMC onboard
- 1 SD card socket
- 1 HDMI, 2 USB 2.0, 1 LAN, 2 COM, 12-bit DIO
- Wide voltage 12~36V DC-in



Panel

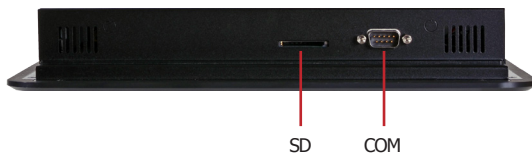

Top View

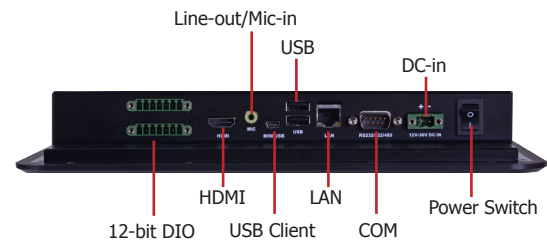

Bottom View

Dimensions

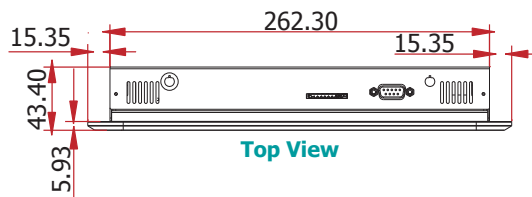

Top View

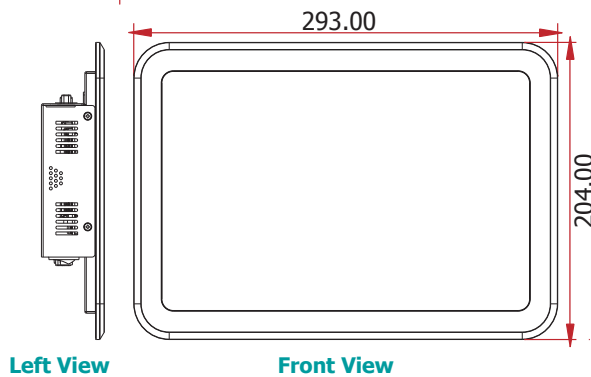

Left View

Front View

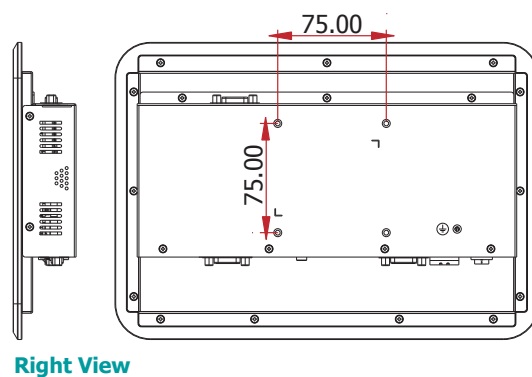

Right View



Bottom View

KS310-IMX6

Specifications * Optional and is not supported in standard model. Please contact your sales representative for more information.

PROCESSOR

- Freescale i.MX 6 series processor
 - i.MX6L: i.MX 6DualLite at 1.0GHz, two cortex-A9 cores

SYSTEM MEMORY

- 2GB DDR3 memory down

LCD and TOUCH SCREEN

- 10.1" (1280x800) TFT touch screen LCD
- 300 NITS
- Projected capacitive touch screen

STORAGE

- 1 SD card socket
- Supports 4GB eMMC onboard

ONBOARD LAN FEATURES

- One Atheros AR8033 Ethernet PHY
- Supports 10Mbps, 100Mbps and 1Gbps data transmission

AUDIO

- 2 built-in 1W speakers (left and right sides)

I/O PORTS

- Bottom
 - 1 DB-9 RS232 serial port
 - 1 HDMI port
 - 1 USB Client port (Type Mini B)
 - 2 USB 2.0/1.1 ports (Type A)
 - 1 Line-out/Mic-in jack
 - 1 2-pole terminal block DC-in
 - 1 LAN port
 - 12-bit DIO 7-pole terminal block (6-bit in/ 6-bit out)
 - 1 Power switch
- Side
 - 2 built-in 1W speakers (left and right sides)
- Top
 - 1 SD card socket
 - 1 DB-9 RS232/422/485 serial port

EXPANSION SLOTS

- 1 Mini PCIe slot
 - Supports PCIe and USB signals
 - Supports full size Mini PCIe card
- 1 mSATA slot (Mini PCIe type)
- 1 SIM card socket
 - Reserved for 3G/LTE module

POWER

- Power input voltage: 12~36V DC-in

FRONT PANEL PROTECTION

- IP65 (Dust Tight; Water Proof protection)

CONSTRUCTION

- Aluminum front bezel
- Rear cover: sheet metal

MOUNTING

- Wall mount (VESA 75x75)
- Panel mount (Mounting clamp)

ENVIRONMENT

- Temperature
 - Operating: 0°C ~ 55°C
 - Storage: -30°C ~ 80°C
- Relative Humidity
 - 85% RH at 65°C

VIBRATION

- Operating: random 1G, 5~500 Hz
- Non-operating: Sine wave, 2G, 10~500Hz

SHOCK

- Operating: 3G peak acceleration (11 m sec. duration)
- Non-operating: 10G peak acceleration (11 m sec. duration)
- IEC 68-2-64 compliant

DIMENSIONS

- 293mm x 204mm x 43.4mm (W x H x D)

WEIGHT

- 1.74 kg

OS SUPPORT

- Android 4.3

CERTIFICATION

- CE
- FCC Class A
- RoHS

KS310-IMX6

Wall Mounting

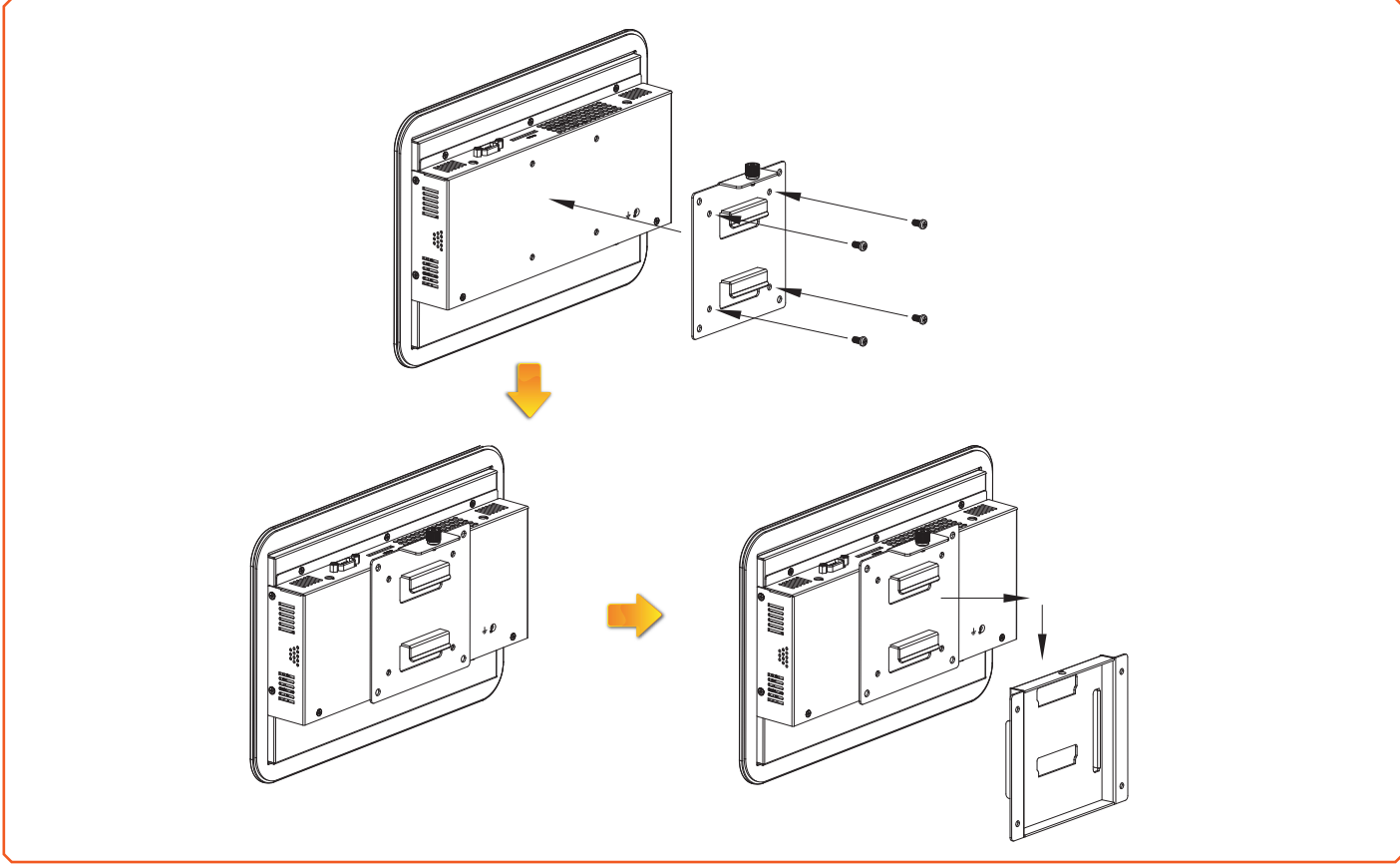

Panel Mounting

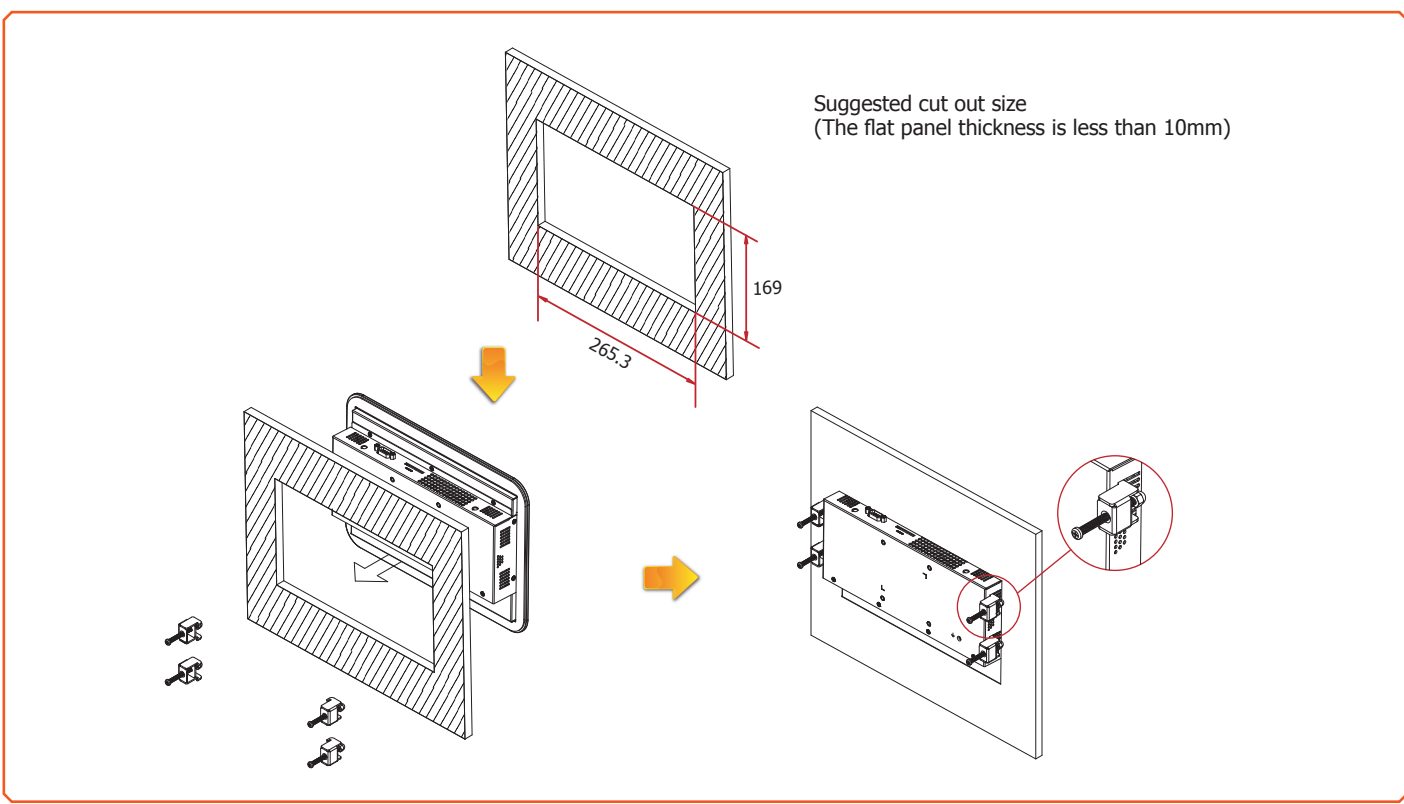

KS310-IMX6

▶ Ordering Information

Model Name	Part Number	Description
KS310-204P6L	750-KS3100-200G	10.1" Touch Panel PC, Freescale i.MX6 Duallite, 2GB DDR3, 4GB eMMC, RJ-45, HDMI, SD card socket, 2 USB, 2 COM, 12-bit DIO, RoHS

More configurations are available for ODM project. Please contact your sales representative for more information.

▶ Optional Items

Optional Items	Part Number	Description
Wall Mount	761-TPC000-000G	Standard Panel PC Wall Mount kit
Panel Mount	761-KS2020-000G	10.1" Panel PC Panel Mount kit
Power Cord	785-PWRD	Power cord, Standards (USA/EUR/CH), 1.8m, RoHS
Power Adapter	671-106012-000G	60W, 12V/5A, Level 6, RoHS

▶ Packing List

• 1 KS310-IMX6 Touch Panel PC
• 1 Quick Installation Guide