

### DUAL OPERATIONAL AMPLIFIER

### KK4560

#### GENERAL DESCRIPTION

The KK4560 integrated circuit is a high-gain, wide bandwidth, dual operational amplifier capable of driving 20 V peak-to-peak into 400 Ω loads. The KK4560 combines many of the features of the KK4558 as well as providing the capability of wider bandwidth, and higher slew rate make the KK4560 ideal for active filters, data and telecommunications, and many instrumentation applications.

#### FEATURES

- Operating Voltage (±4 V ~ ±18 V)
- Wide Gain Bandwidth Product (10 MHz typ.)
- Slew Rate (4 V/μs typ.)
- Bipolar Technology

#### BLOCK DIAGRAM

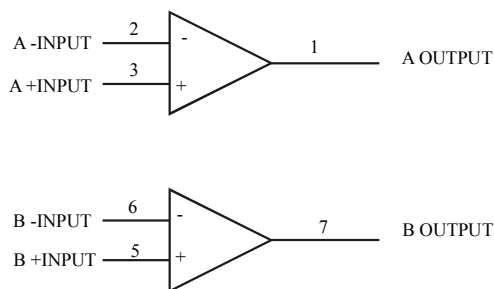

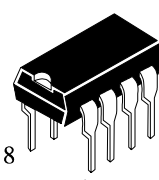

8  
1

N SUFFIX  
PLASTIC

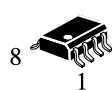

8  
1

D SUFFIX  
SOIC

**ORDERING INFORMATION**  
 KK4560N Plastic  
 KK4560D SOIC  
 T<sub>A</sub> = -40° to 85° C  
 for all packages.

#### PIN ASSIGNMENT

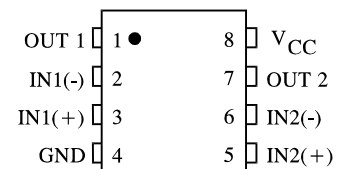

#### EQUIVALENT CIRCUIT (1/2 Show)

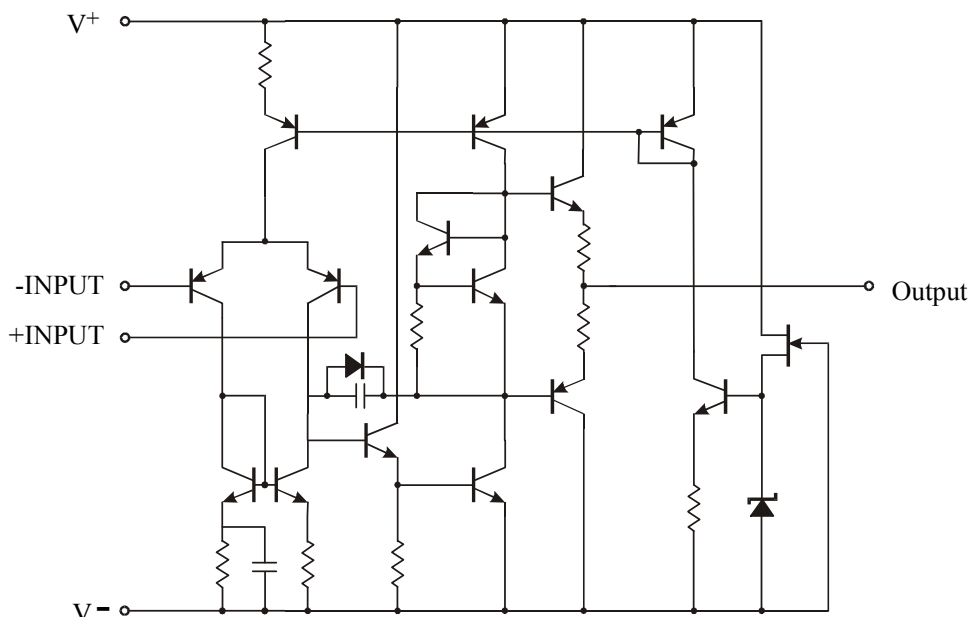

**ABSOLUTE MAXIMUM RATINGS** (Ta=25°C)

| Symbol                         | Parameter                   | Ratings    | Unit |
|--------------------------------|-----------------------------|------------|------|
| V <sup>+</sup> /V <sup>-</sup> | Supply Voltage              | ±18        | V    |
| V <sub>ID</sub>                | Differential Input Voltage  | 30         | V    |
| V <sub>IC</sub>                | Input Voltage               | ±15*       | V    |
| Topr                           | Operation Temperature Range | -40 ~ +85  | °C   |
| Tstg                           | Storage Temperature Range   | -60 ~ +125 | °C   |

\* For supply voltage less than ±15 V, the absolute maximum input voltage is equal to the supply voltage.

**ELECTRICAL CHARACTERISTICS** (Ta=25°C, V<sup>+</sup>/V<sup>-</sup> = ±15)

| Symbol           | Parameter                       | Test Condition                                | Min  | Max | Unit |
|------------------|---------------------------------|---|------|-----|------|
| V <sub>IO</sub>  | Input Offset Voltage            | R <sub>S</sub> ≤ 10 kΩ                        | -    | 6   | mV   |
| I <sub>IO</sub>  | Input Offset Current            |   | -    | 200 | nA   |
| I <sub>B</sub>   | Input Bias Current              |   | -    | 500 | nA   |
| R <sub>IN</sub>  | Input Resistance                |   | 0.3  | -   | MΩ   |
| A <sub>V</sub>   | Large Signal Voltage Gain       | R <sub>L</sub> ≥ 2 kΩ, V <sub>O</sub> = ±10 V | 86   | -   | dB   |
| V <sub>OM1</sub> | Maximum Output Voltage Swing 1  | R <sub>L</sub> ≥ 2 kΩ                         | ±12  | -   | V    |
| V <sub>OM2</sub> | Maximum Output Voltage Swing 2  | I <sub>O</sub> = 25 mA                        | ±10  | -   | V    |
| V <sub>ICM</sub> | Input Common Mode Voltage Range |   | ±12  | -   | V    |
| CMR              | Common Mode Rejection Ratio     | R <sub>S</sub> ≤ 10 kΩ                        | 70   | -   | dB   |
| SVR              | Supply Voltage Rejection Ratio  | R <sub>S</sub> ≤ 10 kΩ                        | 76.5 | -   | dB   |
| I <sub>CC</sub>  | Operating Current               |   | -    | 5.7 | mA   |
| SR               | Slew Rate                       | R <sub>L</sub> ≥ 2 kΩ                         | 3    | 5   | V/μs |

## ■ TYPICAL CHARACTERISTICS

**Open Loop Voltage Gain vs. Frequency**

( $V^+/V^- = \pm 15V$ ,  $R_L = 2k\Omega$ ,  $T_a = 25^\circ C$ )

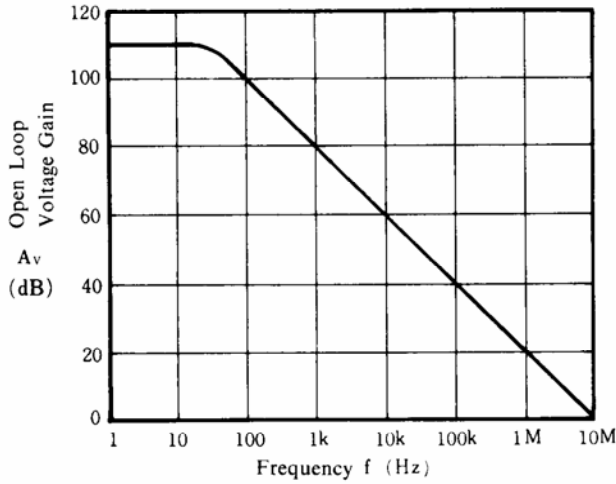

**Maximum Output Voltage Swing vs. Frequency**

( $V^+/V^- = \pm 15V$ ,  $T_a = 25^\circ C$ )

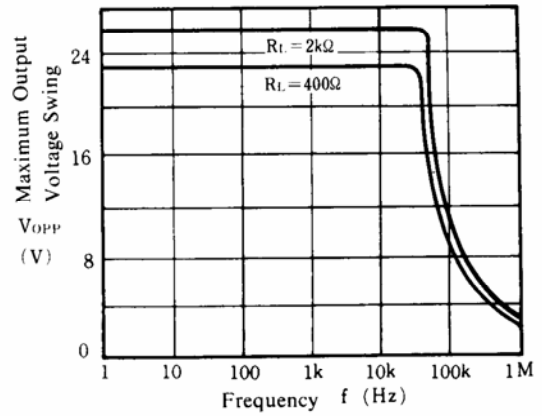

**Maximum Output Voltage Swing vs. Load Resistance**

( $V^+/V^- = \pm 15V$ ,  $T_a = 25^\circ C$ )

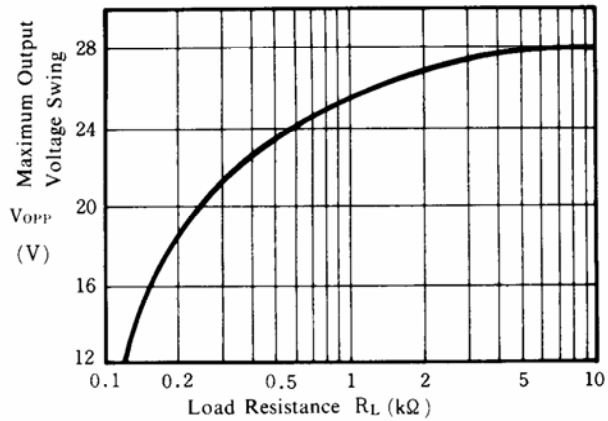

**Equivalent Input Noise Voltage vs. Frequency**

( $V^+/V^- = \pm 15V$ ,  $R_s = 50\Omega$ ,  $A_v = 60dB$ ,  $T_a = 25^\circ C$ )

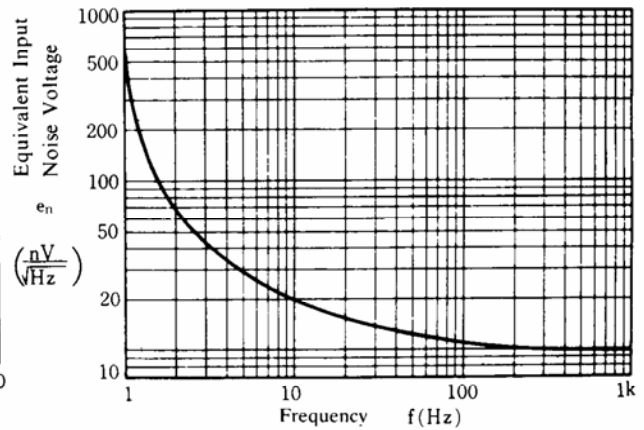

**Operating Current vs. Temperature**

( $V^+/V^- = \pm 15V$ )

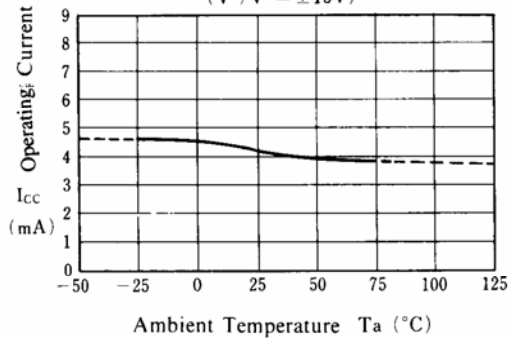

**Maximum Output Voltage Swing vs. Temperature**

( $V^+/V^- = \pm 15V$ ,  $R_L = 2k\Omega$ )

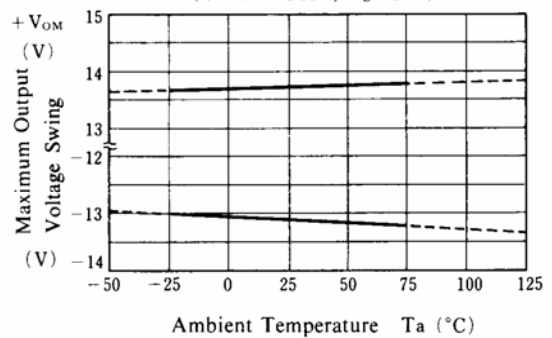

## ■ TYPICAL CHARACTERISTICS

### Input Offset Voltage vs. Temperature

( $V^+/V^- = \pm 15V$ )

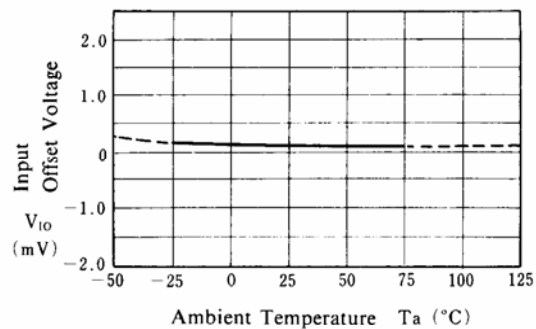

### Input Bias Current vs. Temperature

( $V^+/V^- = \pm 15V$ )

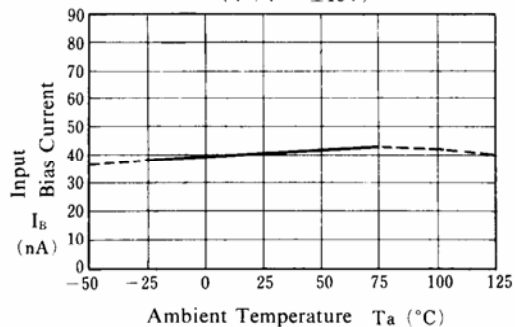

### Maximum Output Voltage Swing vs. Supply Voltage

( $R_L = 400\Omega$ ,  $T_a = 25^\circ C$ )

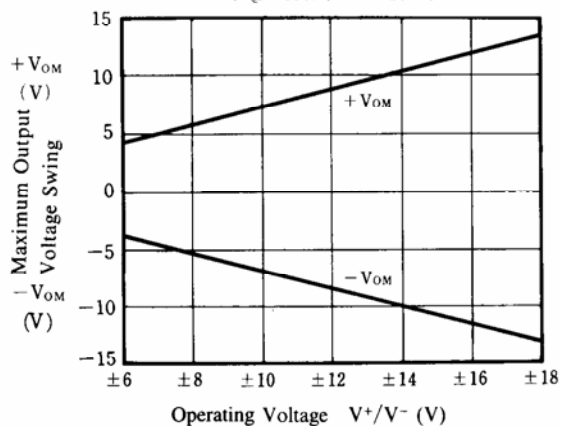

### Operating Current vs. Operating Voltage

( $T_a = 25^\circ C$ )

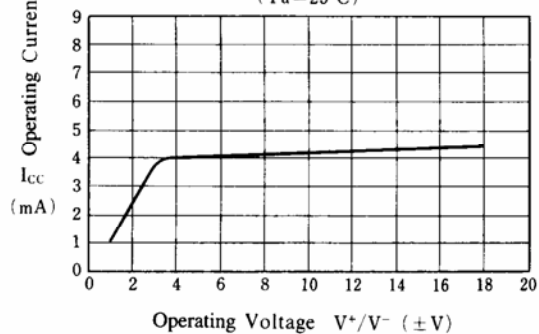

### N SUFFIX PLASTIC DIP (MS - 001BA)

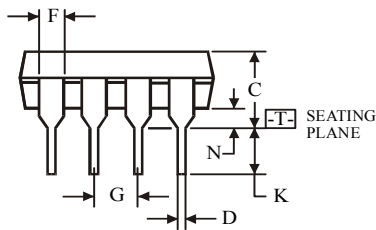
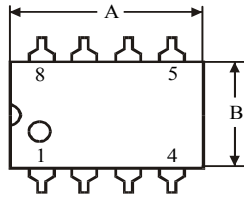
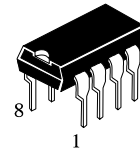

$\oplus 0.25 (0.010) \text{ (M) } T$

| Symbol | Dimension, mm |       |
|--------|---------------|-------|
|        | MIN           | MAX   |
| A      | 8.51          | 10.16 |
| B      | 6.1           | 7.11  |
| C      |               | 5.33  |
| D      | 0.36          | 0.56  |
| F      | 1.14          | 1.78  |
| G      | 2.54          |       |
| H      | 7.62          |       |
| J      | 0°            | 10°   |
| K      | 2.92          | 3.81  |
| L      | 7.62          | 8.26  |
| M      | 0.2           | 0.36  |
| N      | 0.38          |       |

#### NOTES:

- Dimensions "A", "B" do not include mold flash or protrusions.  
Maximum mold flash or protrusions 0.25 mm (0.010) per side.

### D SUFFIX SOIC (MS - 012AA)

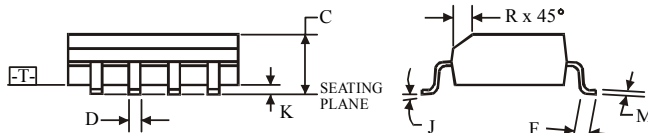
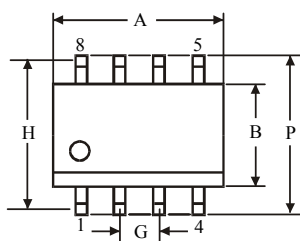
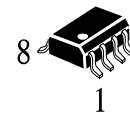

$\oplus 0.25 (0.010) \text{ (M) } T \text{ (C) } \text{ (M)}$

| Symbol | Dimension, mm |      |
|--------|---------------|------|
|        | MIN           | MAX  |
| A      | 4.8           | 5    |
| B      | 3.8           | 4    |
| C      | 1.35          | 1.75 |
| D      | 0.33          | 0.51 |
| F      | 0.4           | 1.27 |
| G      | 1.27          |      |
| H      | 5.72          |      |
| J      | 0°            | 8°   |
| K      | 0.1           | 0.25 |
| M      | 0.19          | 0.25 |
| P      | 5.8           | 6.2  |
| R      | 0.25          | 0.5  |

#### NOTES:

- Dimensions A and B do not include mold flash or protrusion.
- Maximum mold flash or protrusion 0.15 mm (0.006) per side for A; for B - 0.25 mm (0.010) per side.