



**Preliminary Product Information**  
**MicroPower Charge Pump Converter**

## FEATURES

- Step-Up Voltage Converter
- Input Voltage Range: 2.7 to 5.0V
- Low input current 25 $\mu$ A
- High Output Voltage Accuracy  $\pm$ 3%
- 150mA output current with  $V_{IN} \geq 3.3V$
- Peak Current 250mA for 100ms
- High Frequency 750kHz Operation
- Logic-Controlled Shutdown
- Short-Circuit/Over-Temperature Protection
- Lead (Pb) Free SOT23-6 Package

## APPLICATIONS

Cellular Phones  
 Digital Cameras  
 Handheld Electronics  
 LED/Display Backlight Driver  
 LEDs for Camera Flash  
 Portable Communication Devices  
 MP3 Players  
 GPS Receivers  
 PDAs

## DESCRIPTION

The KB3310 is a MicroPower switched capacitor voltage converter that delivers a regulated output. No external inductor is required for operation.

The KB3310 can deliver up to 150mA to the voltage regulated output. It features very low quiescent current and high efficiency over a large portion of its load range, making this device ideal for battery-powered applications. Furthermore, the combination of few external components and small package size keeps the total converter board area to a minimum in space-restricted applications.

The KB3310 uses a pulse skipping technique to provide a regulated output from a varying input supply. The KB3310 contains a thermal management circuit to protect the device under continuous output short-circuit conditions.

The KB3310 has lead (Pb) free SOT23-6 package and is rated over the -30°C to +85°C temperature range.

## APPLICATION CIRCUIT

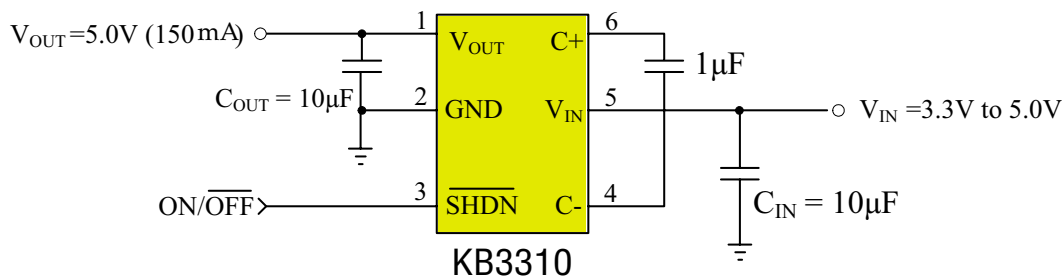



## PIN CONFIGURATION

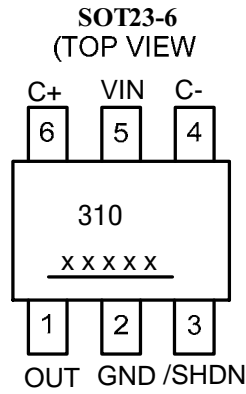

## ORDER INFORMATION

Part number	Package	Marking
KB3310 GRE	SOT23-6, Green	310, Date Code with one bottom line

xxxxx : Date Code

## PIN DESCRIPTION

Pin No.	Symbol	I/O	Description
1	OUT	O	Regulated Output
2	GND	P	Ground
3	/SHDN	I	Chip Enable Input
4	CN	-	Flying Capacitor negative terminal
5	VIN	P	Input Supply
6	CP	+	Flying Capacitor positive terminal



**Preliminary Product Information**  
**MicroPower Charge Pump Converter**

## ABSOLUTE MAXIMUM RATINGS (Ta=+25°C)

Parameter	Symbol	Condition	Rated Value		Unit
			Min.	Max.	
Power supply voltage	V <sub>IN</sub>	—	—	6.5	V
OUT pin voltage	V <sub>OUT</sub>	—	—	6.5	V
SHDN pin voltage	V <sub>SHDN</sub>	—	—	6.5	V
Allowable dissipation	P <sub>D</sub>	—	—	250	mW
Operating temperature	T <sub>OP</sub>	—	-30	+85	°C
Storage temperature	T <sub>stg</sub>	—	-55	+125	°C

## ELECTRICAL CHARACTERISTICS (Ta=+25°C)

Parameter	Symbol	Condition	Values			Unit
			Min.	Typ.	Max.	
Input Voltage	V <sub>IN</sub>	V <sub>OUT</sub> =5.0V	2.7	-	V <sub>OUT</sub>	V
No Load Supply Current	V <sub>Start</sub>	2.7V < V <sub>IN</sub> < 5.0V, I <sub>OUT</sub> =0mA, /SHDN=V <sub>IN</sub>	-	25	40	μA
Output Voltage	V <sub>OUT</sub>	2.7V < V <sub>IN</sub> < 5.0V, I <sub>OUT</sub> ≤50mA	4.85	5.0	5.15	V
		3.3V < V <sub>IN</sub> < 5.0V, I <sub>OUT</sub> ≤150mA	4.85	5.0	5.15	V
Shutdown Current	I <sub>SHDN</sub>	2.7V < V <sub>IN</sub> < 3.6V, I <sub>OUT</sub> =0mA, EN=0V	-	-	1	μA
		3.6V < V <sub>IN</sub> < 5.0V, I <sub>OUT</sub> =0mA, EN=0V	-	-	4	μA
Ripple Current	V <sub>Ripple</sub>	V <sub>IN</sub> =3V, I <sub>OUT</sub> =50mA	-	25	-	mV
		V <sub>IN</sub> =3.3V, I <sub>OUT</sub> =150mA	-	40	-	mV
Efficiency	η	V <sub>IN</sub> =3V, I <sub>OUT</sub> =50mA	-	85	-	%
		V <sub>IN</sub> =2.7V, I <sub>OUT</sub> =50mA	-	93	-	%
Frequency	F	Oscillator Free Running	600	850	1000	KHz
EN Input Threshold	V <sub>IH</sub>		1.4	-	-	V
	V <sub>IL</sub>		-	-	0.3	V
EN Input Current	I <sub>IH</sub>	EN= V <sub>IN</sub>	-2	-	2	μA
	I <sub>IL</sub>	EN= 0V	-2	-	2	μA
OUT Turn-ON time	t <sub>ON</sub>	V <sub>IN</sub> =3V, I <sub>OUT</sub> =0mA	-	2	-	ms
Short-Circuit Current	I <sub>SC</sub>	V <sub>IN</sub> =3V, V <sub>OUT</sub> =GND, EN=3V	-	300	-	mA



*Preliminary Product Information*  
MicroPower Charge Pump Converter

## TYPICAL PERFORMANCE CHARACTERISTICS

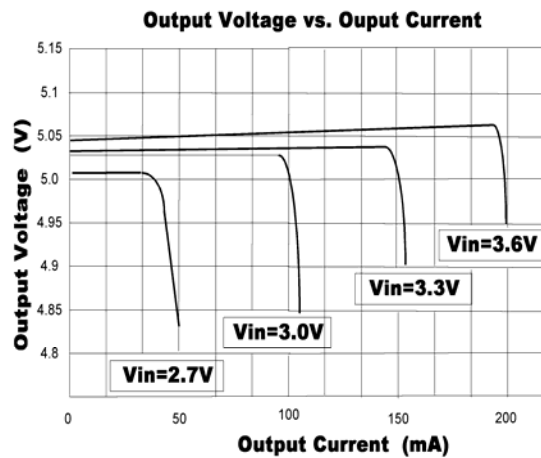
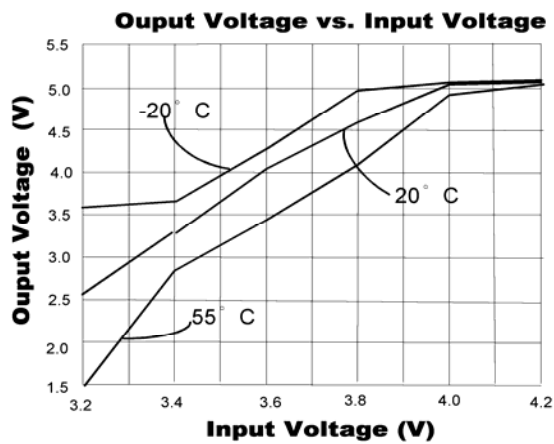
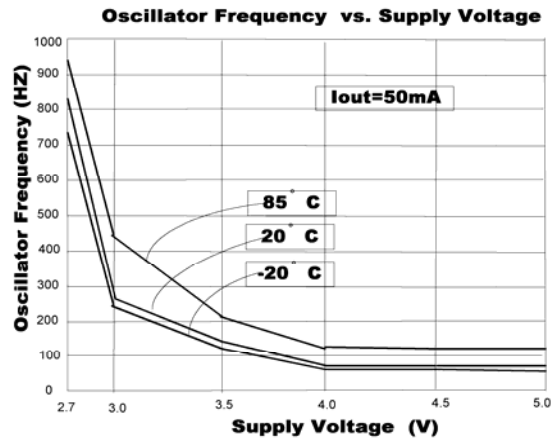
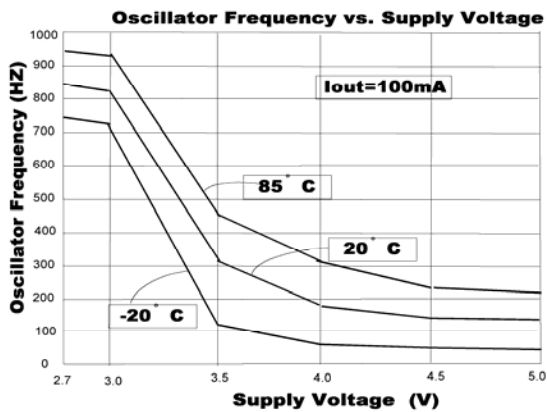
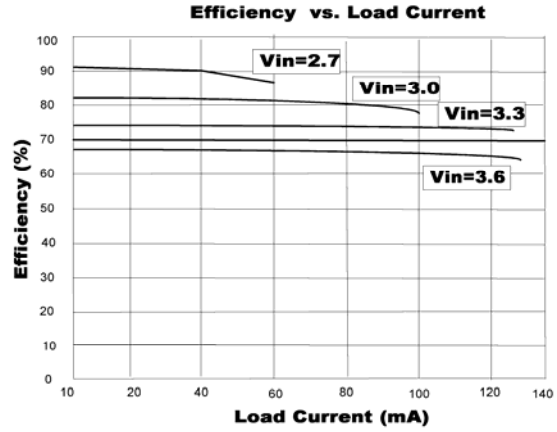
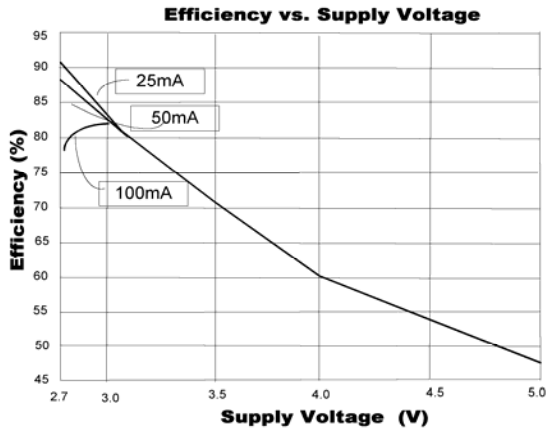



## TYPICAL PERFORMANCE CHARACTERISTICS

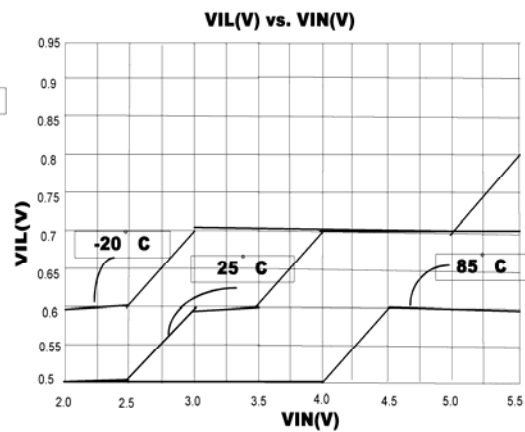
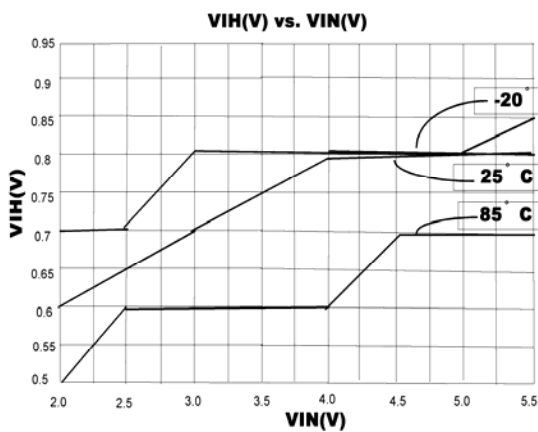
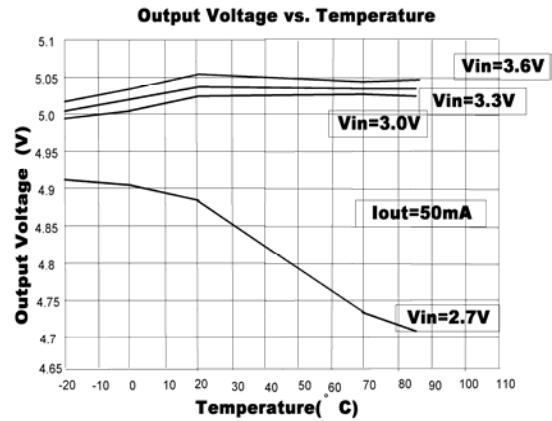
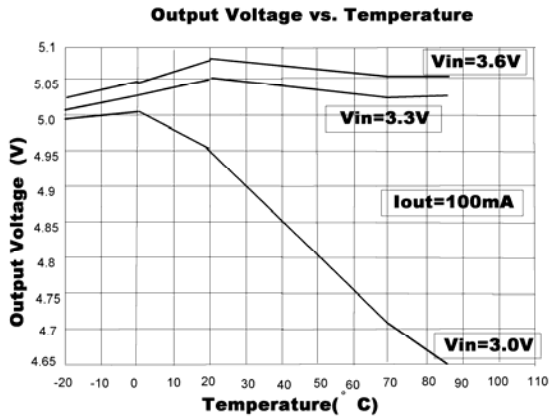

## APPLICATION CIRCUIT

LED Driver from a Li-Ion Battery Source

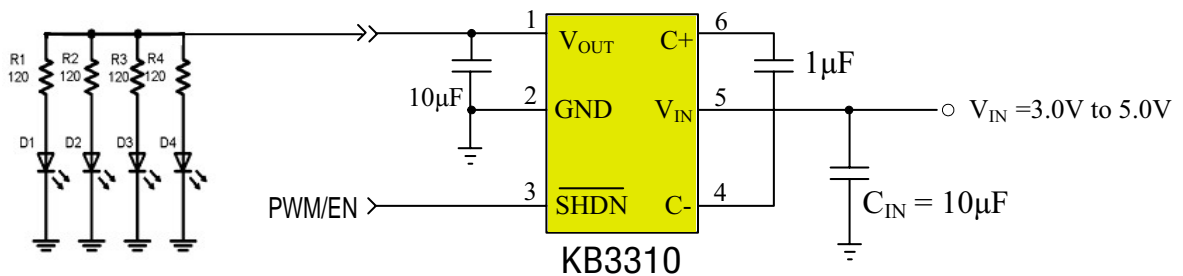



## APPLICATION INFORMATION

### 1. Capacitor Selection

It is very important to select the capacitors  $C_{IN}$ ,  $C_{OUT}$  and  $C_{FLY}$  because they will affect turn on time, output ripple and transient performance. Ceramic capacitors offer many advantages over other tantalum and aluminum electrolytic counterparts. In general, the capacitors can be used 10 $\mu$ F for  $C_{IN}$  and  $C_{OUT}$ , and 1 $\mu$ F for  $C_{FLY}$  under maximum output load conditions. Lower values for  $C_{IN}$ ,  $C_{OUT}$  and  $C_{FLY}$  may be utilized for light load current applications. Large ceramic capacitors are typically composed of X7R, X5R, Z5U or Y5V dielectric materials. If Y5V and Z5U are selected for used with the charge pump, the nominal value should be doubled to compensated for the capacitor tolerance which can vary more than  $\pm 50\%$  over operating temperature range. X7R and X5R dielectrics are much more desirable. The temperature tolerance of X7R dielectric is better than  $\pm 15\%$  .

### 2. Charge Pump Efficiency

The KB3310 is a regulated output voltage charger pump converter. The Efficiency can be defined as a linear voltage regulator with an effective output voltage that is equal to two times the input voltage. The expression to define the ideal efficiency can be shown as:

$$\eta = \frac{P_{OUT}}{P_{IN}} = \frac{V_{OUT} \times I_{OUT}}{V_{IN} \times 2I_{OUT}} = \frac{V_{OUT}}{2 \times V_{IN}}$$

Refer to the Typical Characteristics section for measured plots of efficiency versus input voltage and output load current for the given charge pump output voltage options.

### 3. Layout Guideline

As a general rule for charge pump boost converters, all external capacitors should be located as closed as possible to the device package with minimum length trace connections. A local component side ground plane is recommended. If this is not possible due to the layout limitations, assure good ground connections by the use of large or multiple PCB via's.



## PACAGE DESCRIPTION

Small Outline SOT23-6

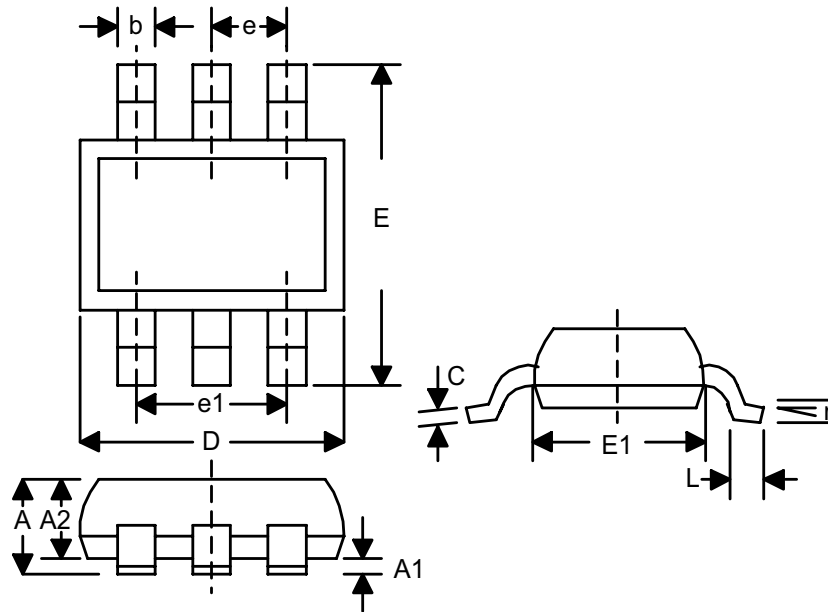

SYMBOL	INCHES		MILLIMETERS		NOTES
	MIN	MAX	MIN	MAX	
A	0.035	0.057	0.90	1.45	-
A1	0.000	0.006	0.00	0.15	-
A2	0.035	0.051	0.90	1.30	-
b	0.010	0.020	0.25	0.50	-
C	0.003	0.008	0.08	0.20	-
D	0.110	0.122	2.80	3.10	-
E	0.102	0.118	2.60	3.00	-
E1	0.059	0.069	1.50	1.75	-
L	0.014	0.022	0.35	0.55	-
e	0.037ref		0.95ref		-
e1	0.075ref		1.90ref		-
r	0 <sup>0</sup>	10 <sup>0</sup>	0 <sup>0</sup>	10 <sup>0</sup>	-