

KA3032

5-Channel Motor Drive IC

Features

- 4-CH balanced transformerless (BTL) driver
- 1-CH (forward-reverse) control DC motor driver
- Operating supply voltage (4.5V ~ 16V)
- Built-in thermal shut down circuit (TSD)
- Built-in under voltage lockout circuit (UVLO)
- Built-in over voltage protection circuit (OVP)
- Built-in mute circuit (CH1, CH2, CH3 and CH4)
- Built-in normal op-amp
- Built-in 5V regulator with reset

Description

The KA3032 is a monolithic integrated circuit suitable for a 5-ch motor driver which drives the tracking actuator, focus actuator, sled motor, spindle motor, and tray motor of the CDP system.

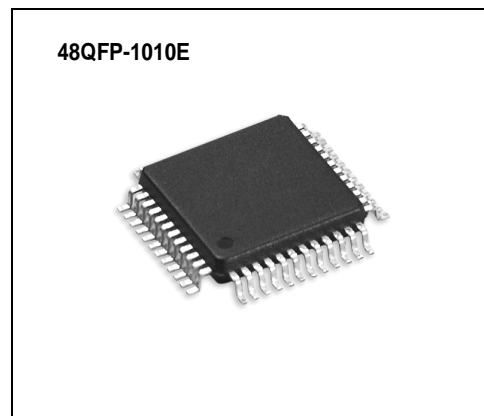

Typical Applications

- Compact disk player (CDP)
- Video compact disk player (VCD)
- Automotive compact disk player (CDP)
- Other compact disk media

Ordering Information

Device	Package	Operating Temp.
KA3032	48-QFP-1010E	-35°C ~ +85°C

Pin Assignments

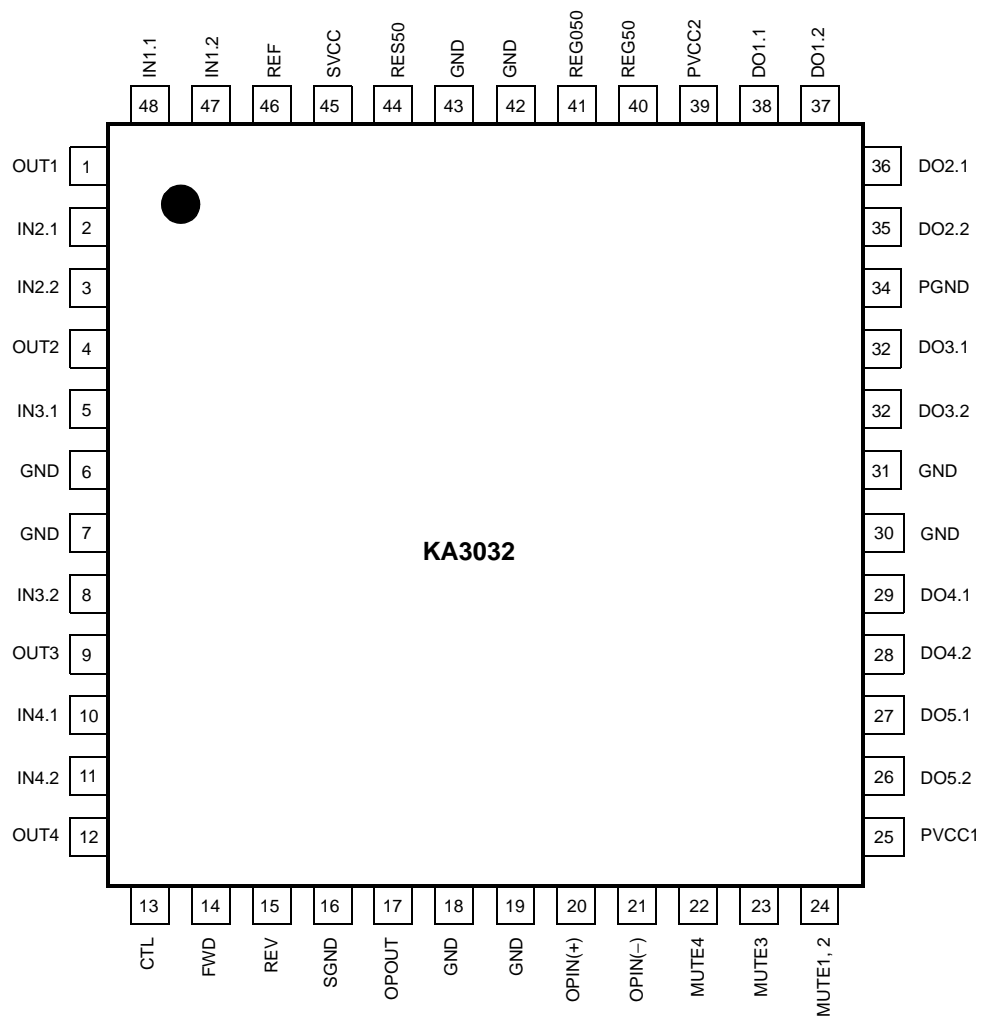

Pin Definitions

Pin Number	Pin Name	I/O	Pin Function Description
1	OUT1	O	CH 1 op-amp output
2	IN2.1	I	CH 1 op-amp input (+)
3	IN2.2	I	CH 2 op-amp input (-)
4	OUT2	O	CH 2 op-amp output
5	IN3.1	I	CH 3 op-amp input (+)
6	GND	-	Ground
7	GND	-	Ground
8	IN3.2	I	CH 3 op-amp input (-)
9	OUT3	O	CH 3 op-amp output
10	IN4.1	I	CH 4 op-amp input (+)
11	IN4.2	I	CH 4 op-amp input (-)
12	OUT4	O	CH 4 op-amp output
13	CTL	I	CH 5 motor speed control
14	FWD1	I	CH 5 forward input
15	REW1	I	CH 5 reverse input
16	SGND	-	Signal ground
17	OPOUT	O	Opamp output
18	GND	-	Ground
19	GND	-	Ground
20	OPIN(+)	I	Opamp input (+)
21	OPIN(-)	I	Opamp inpt (-)
22	MUTE4	I	CH 4 mute
23	MUTE3	I	CH 3mute
24	MUTE1, 2	I	CH 1, CH 2 mute
25	PVCC1	-	Power supply voltage (For CH 5)
26	DO5.2	O	CH 5 drive output
27	DO5.1	O	CH 5 drive output
28	DO4.2	O	CH 4 drive output
29	DO4.1	O	CH 4 drive output
30	GND	-	Ground
31	GND	-	Ground
32	DO3.2	O	CH 3 drive output
33	DO3.1	O	CH 3 drive output
34	PGND	-	Power ground
35	DO2.2	O	CH 2 drive output
36	DO2.1	O	CH 2 drive output
37	DO1.2	O	CH 1 drive output
38	DO1.1	O	CH 1 drive output
39	PVCC2	-	Power supply voltage (For CH 1, CH 2, CH 3, CH 4)

Pin Definitions (Continued)

Pin Number	Pin Name	I/O	Pin Function Description
40	REG50	O	Regulator output
41	REG050	O	Regulator 5V output
42	GND	-	Ground
43	GND	-	Ground
44	RES50	I	Regulator reset
45	SVCC	-	Signal supply voltage
46	REF	I	Bias voltage input
47	IN1.1	I	CH 1 opamp input (+)
48	IN1.2	I	CH 1 opamp input (-)

Internal Block Diagram

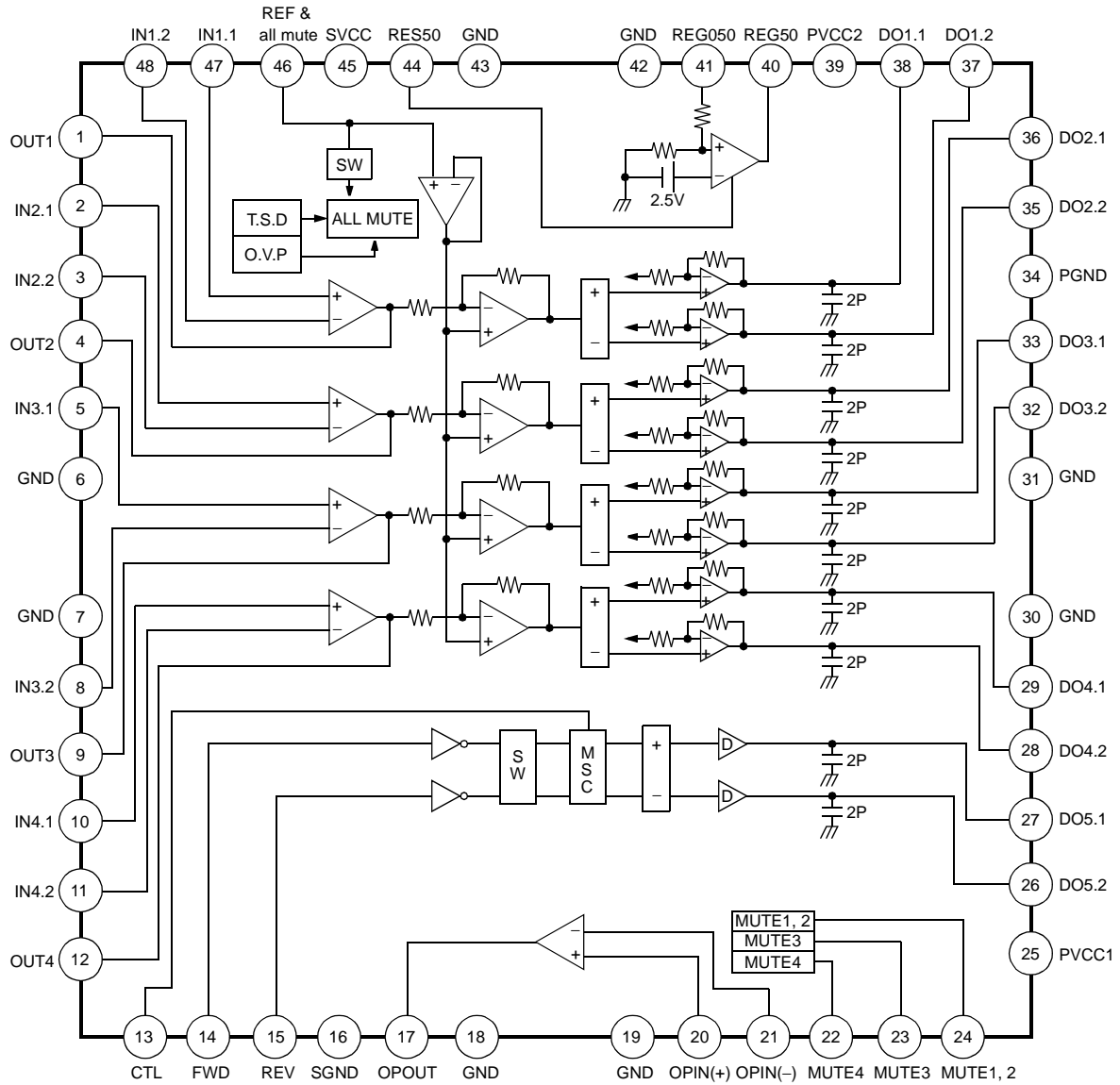

Notes:

1. SW = Logic switch
2. MSC = Motor speed control
3. D = Output driver

Equivalent Circuits

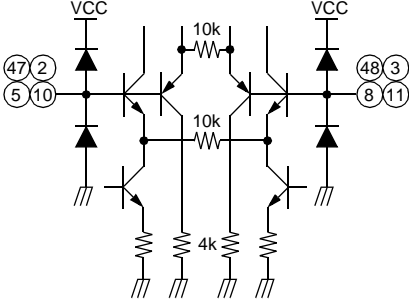
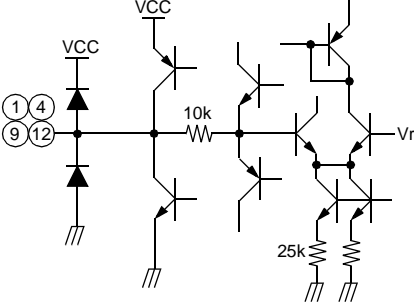
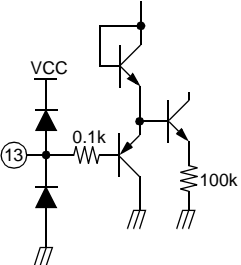
Description	Pin No.	Internal circuit
Input OPIN (+) OPIN (-)	47, 2, 5, 10 48, 3, 8, 11	
Input opout	1, 4, 9, 12	
CTL	13	

Equivalent Circuits (Continued)

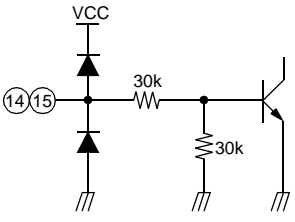
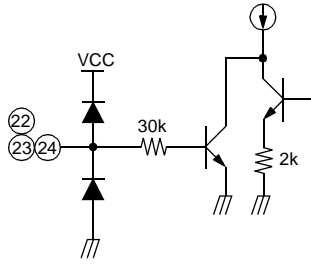
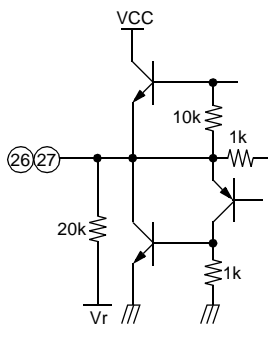
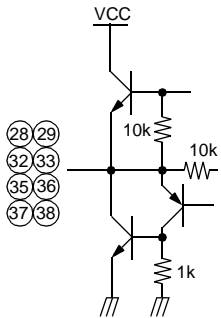
Description	Pin No.	Internal circuit
Logic drive FWD input REV input	14 15	
CH mute	22, 23, 24	
Logic drive output	26, 27	
4-CH drive output	28, 29 32, 33 35, 36 37, 38	

Equivalent Circuits (Continued)

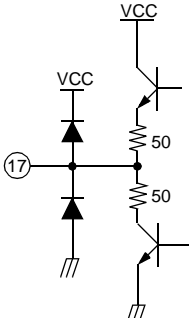
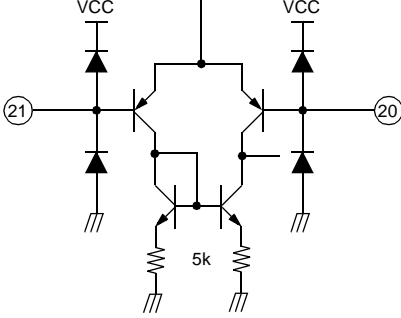
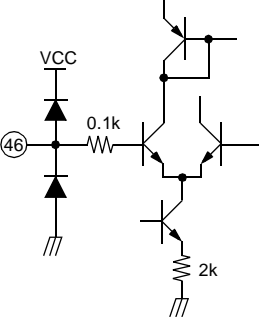
Description	Pin No.	Internal circuit
Normal opout	17	
Normal OPIN(+) OPIN(-)	20 21	
Ref	46	

Equivalent Circuits (Continued)

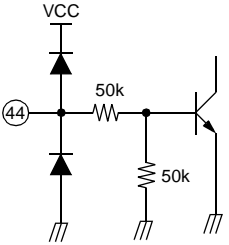
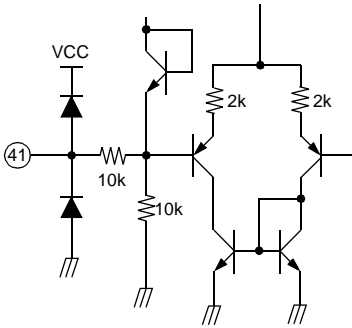
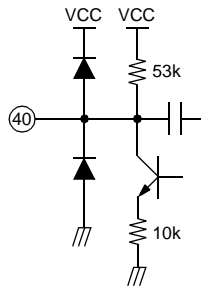
Description	Pin No.	Internal circuit
RES50	44	
REG050	41	
REG50	40	

Absolute Maximum Ratings (Ta = 25°C)

Parameter	Symbol	Value	Unit
Maximum supply voltage	VCCMAX	18	V
Power dissipation	PD	2.3 ^{note}	W
Operating temperature	TOPR	-35 ~ +85	°C
Storage temperature	TSTG	-55 ~ +150	°C
Maximum output current	IOMAX	1	A

NOTE:

1. When mounted on 70mm × 70mm × 1.6mm PCB.
2. Power dissipation reduces 14mW / °C for using above Ta=25°C.
3. Do not exceed Pd and SOA.

Power Dissipation Curve

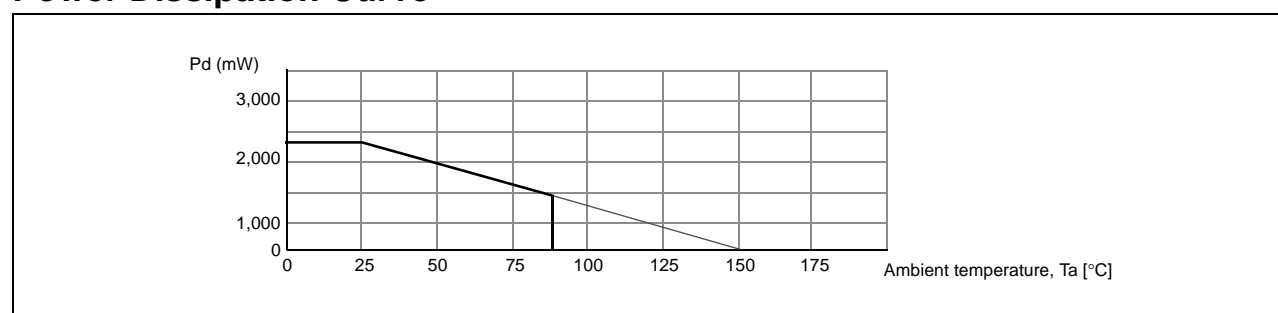

Recommended Operating Conditions (Ta = 25°C)

Parameter	Symbol	Min	Typ	Max	Unit
Operating supply voltage	VCC	4.5	-	16	V

Electrical Characteristics

($V_{CC}=PV_{CC1}=PV_{CC2}=8V$, $T_a=25^{\circ}C$, unless otherwise specified)

Parameter	Symbol	Conditions	Min.	Typ.	Max.	Units
Quiescent circuit current	ICC	under no-load	9	12	16	mA
All mute on current	IMUTE ALL	Pin 46=GND	-	6	10	mA
All mute on voltage	VMON ALL	Pin 46=Variation	-	-	0.5	V
All mute off voltage	VMOFF ALL	Pin 46=Variation	2	-	-	V
CH mute on voltage	VMON CH	Pin 22, 23, 24=Variation	2	-	-	V
CH mute off voltage	VMOFF ALL	Pin 22, 23, 24=Variation	-	-	0.5	V
DRIVER PART ($R_L=8\Omega$)						
Input offset voltage	VIO	-	-20	-	+20	mV
Output offset voltage	VOO	$V_{IN}=2.5V$	-50	-	+50	mV
Maximum output voltage 1	VOM1	$V_{CC}=8V$, $R_L=8\Omega$	4.7	5.5	-	V
Maximum output voltage 2	VOM2	$V_{CC}=13V$, $R_L=24\Omega$	7	9	-	V
Closed-loop voltage gain	AVF	$V_{IN}=0.1V_{RMS}$	9	10.5	12	dB
Ripple rejection ratio	RR	$V_{IN}=0.1V_{RMS}$, $f=120kHz$	-	50	-	dB
Slew rate	SR	Square, $V_{out}=2V_{p-p}$, $f=120kHz$	-	0.8	-	$V/\mu s$
NORMAL OPAMP PART						
Input offset voltage	VOF1	-	-10	-	+10	mV
Input bias current	IB1	-	-	-	300	nA
High level output voltage	VOH1	$R_L=50\Omega$	6	6.8	-	V
Low level output voltage	VOL1	$R_L=50\Omega$	-	1.0	1.8	V
Output sink current	ISINK1	$V_{IN}=-75dB$, $f=1kHz$	10	40	-	mA
Output source current	ISOURCE1	$V_{IN}=-20dB$, $f=120kHz$	10	40	-	mA
Open loop voltage gain	GVO1	Square, $V_{out}=2V_{p-p}$, $f=120kHz$	-	75	-	dB
Ripple rejection ratio	RR1	$V_{IN}=-20dB$, $f=1kHz$	-	65	-	dB
Slew rate	SR1	-	-	1	-	$V/\mu s$
Common mode rejection ratio	CMRR1	-	-	80	-	dB

Electrical Characteristics (Continued)

($V_{CC}=PV_{CC1}=PV_{CC2}=8V$, $T_a=25^{\circ}C$, unless otherwise specified)

Parameter	Symbol	Conditions	Min.	Typ.	Max.	Units
INPUT OPAMP PART						
Input offset voltage	V_{OF2}	-	-10	-	+10	mV
Input bias current	I_{B2}	-	-	-	400	nA
High level output voltage	V_{OH2}	-	7	7.7	-	V
Low level output voltage	V_{OL2}	-	-	0.2	0.5	V
Output sink current	I_{SINK2}	-	500	800	-	μA
Output source current	$I_{SOURCE2}$	-	500	800	-	μA
Open loop voltage gain	G_{VO2}	$V_{IN}=-75dB$, $f=1kHz$	-	80	-	dB
Slew rate	$SR2$	Square, $V_{out}=2Vp-p$, $f=120kHz$	-	1	-	$V/\mu s$
Common mode rejection ratio	$CMRR2$	$V_{IN}=-20dB$, $f=1kHz$	-	80	-	dB
5V REGULATOR PART						
Regulator output voltage	V_{reg}	$I_L=100mA$	4.75	5	5.25	V
Load regulation	ΔV_{R1}	$I_L=0 \rightarrow 200mA$	-40	0	+10	mV
Line regulation	ΔV_{CC}	$I_L=200mA$, $V_{CC}=6V \rightarrow 9V$	-20	0	+30	mV
Reset on voltage	Res_{on}	-	-	-	0.5	V
Reset off voltage	Res_{off}	-	2	-	-	V
TRAY, CHANGER DRIVER PART($R_L=45\Omega$)						
Input high level voltage	V_{IH}	-	2	-	-	V
Input low level voltage	V_{IL}	-	-	-	0.5	V
Output voltage 1	V_{O1}	$V_{CC}=8V$, $V_{CTL}=3.5V$, $R_L=8\Omega$	5.0	5.3	5.6	V
Output voltage 2	V_{O2}	$V_{CC}=8V$, $V_{CTL}=3.5V$, $R_L=45\Omega$	5.2	6.0	6.8	V
Output voltage 3	V_{O3}	$V_{CC}=13V$, $V_{CTL}=4.5V$, $R_L=45\Omega$	7.5	8.5	9.5	V
Output load regulation	ΔV_{R1}	-	-	300	700	mV
Output offset voltage 1	V_{OO1}	$V_{IN}=5V$, $5V$	-10	-	+10	mV
Output offset voltage 2	V_{OO2}	$V_{IN}=0V$, $0V$	-10	-	+10	mV

Application Information

1. REFERENCE INPUT & MUTE

Pin 46 (REF) uses the reference input pin or the all mute input pin a reference input block circuit.

- Reference input
In the case of external reference input, the applied voltage range must be between 2[V] and 6.5[V] at $V_{CC}=8[V]$.
- All mute input
Using the all mute function pin, the applied voltage condition is as follows.

All mute on voltage	Below 0.5[V]	Mute function operation
All mute off voltage	Above 2.0[V]	Normal operation

2. SEPARATED CHANNEL MUTE FUNCTION

These pins are used for the individual channel mute operation.

- When the mute pins (pin22, 23 and 24) are high level, the mute circuits are activated so that the output circuit is muted.
- When the voltage of the mute pins (pin22, 23 and 24) are low level, the mute circuit is stopped and output circuits operate normally.
- If the chip temperature rises above 175°C, then the thermal shutdown (TSD) circuit is activated and the output circuits are muted.
 - Mute 1, 2 (pin 24)-CH1, 2 mute control input pin.
 - Mute 3 (pin 23)-CH3 mute control input pin.
 - Mute 4 (pin 22)-CH4 mute control input pin.

3. PROTECTION FUNCTION

- Thermal shutdown (TSD)
If the chip temperature rises above 175°C, then the thermal shutdown (TSD) circuit is activated and the output circuit is mute. The TSD circuit is temperature hysteresis about 25°C.
- Under voltage lockout (UVLO) and over voltage protection (OVP)
It is designed to mute operate the internal bias by the function of UVLO and OVP, when the power supply voltage falls below 3.5[V] or above 20[V].

4. REGULATOR & RESET FUNCTION

The regulator and reset circuits are as illustrated in Figure 1.
where $R1=R2$.

- The external circuit is composed of the transistor, KSB772 and a capacitor, about $33[\mu\text{F}]$. The capacitor is used as a ripple eliminator and should have good temperature characteristics.
- The regulator output voltage (pin 41) is decided as follows.
 $V_{out} = 2 \times 2.5 = 5[\text{V}]$ (where $R1=R2$)
- When the voltage of pin 44 (V_{reset}) is at $5[\text{V}]$, regulator output voltage (pin 41) is $5[\text{V}]$, and if $0[\text{V}]$, the output voltage of pin 41 is $0[\text{V}]$.

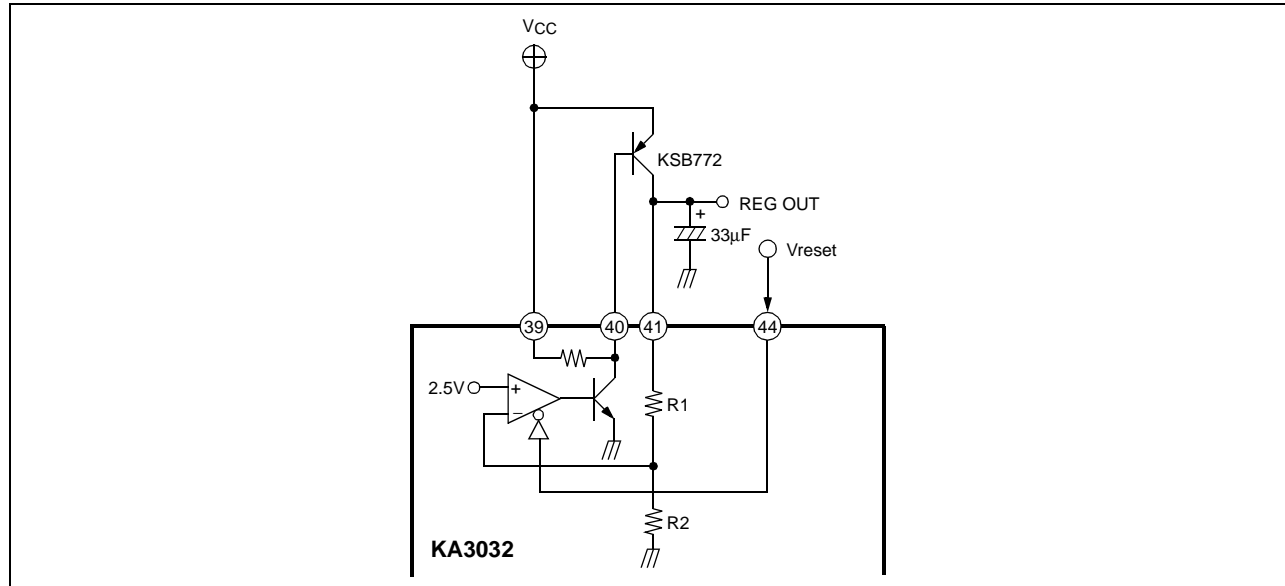
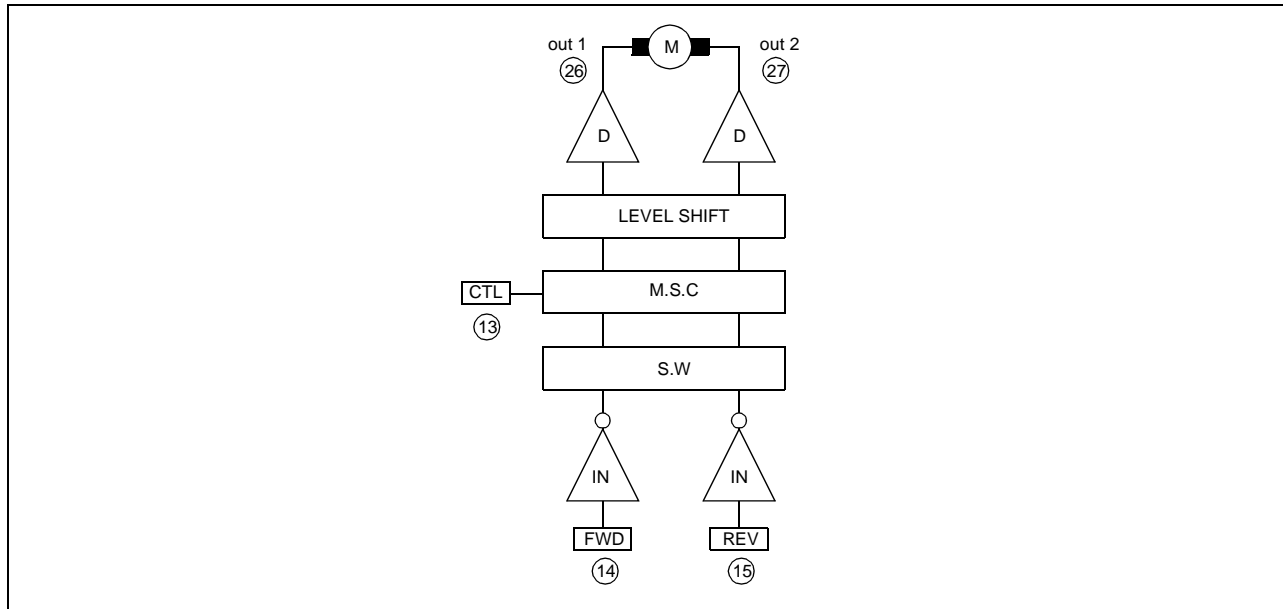

Figure 1. Regulator circuit

6. TRAY, CHANGE MOTOR DRIVE PART



- Rotational Direction Control

The forward and reverse rotational direction is controlled by FWD (pin 14), and REV (pin 15) inputs. Conditions are as follows.

INPUT		OUTPUT		
FWD	REV	OUT 1	OUT 2	State
H	H	Vr	Vr	Brake
H	L	H	L	Forward
L	H	L	H	Reverse
L	L	Vr	Vr	Brake

where Vr is $(V_{cc} - V_{be}) / 2 = 3.65V$ (at $V_{cc}=8V$)

where Out1 pins are pins 24 and 26, and out2 pins are pins 25 and 27

- Motor Speed Control

- The almost maximum torque is obtained when it is used with the pins 13 (CTL) open.
- If the torque of the motor is too low, then the applied voltage at pins 13 (CTL) is 0[V].
- When motor speed controlled, the applied voltage of the pins 13 (CTL) is between 0 and 4V. Also, if speed control is constant, the applied voltage of the pins 13 (CTL) is between 4 and 5V.
- This IC's applied maximum voltage is 6V when V_{CC} is 8V.
- You must not use the applied CTL voltage above 5.8V when V_{cc} is 8V, and 3V when V_{CC} is 5V.

Typical Performance Characteristics

Total circuit

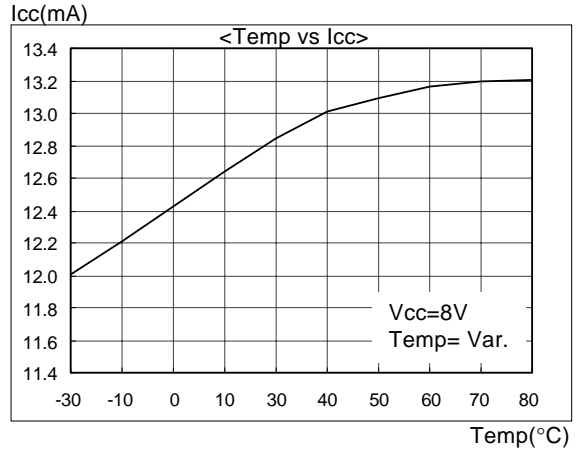
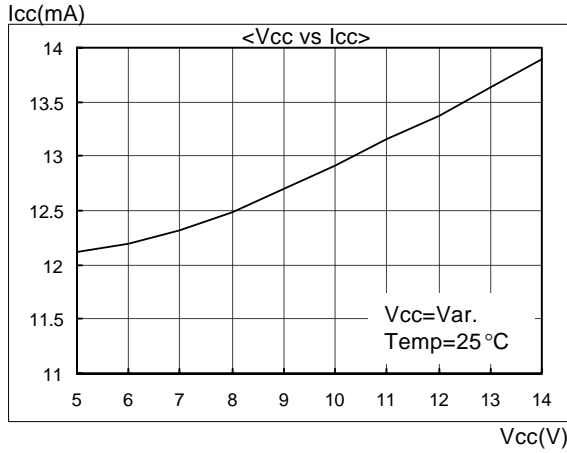

Focus, Tracking, Spindle, Sled drive part

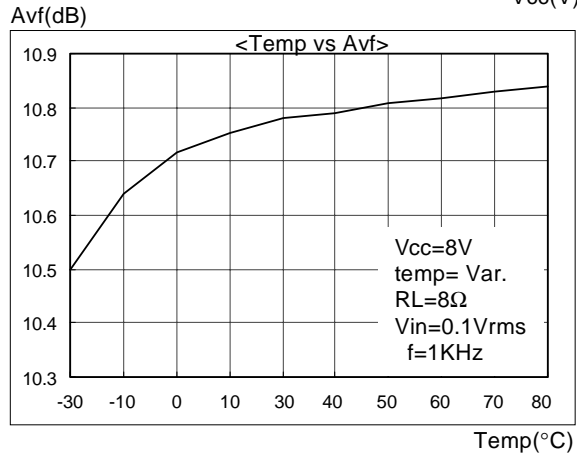
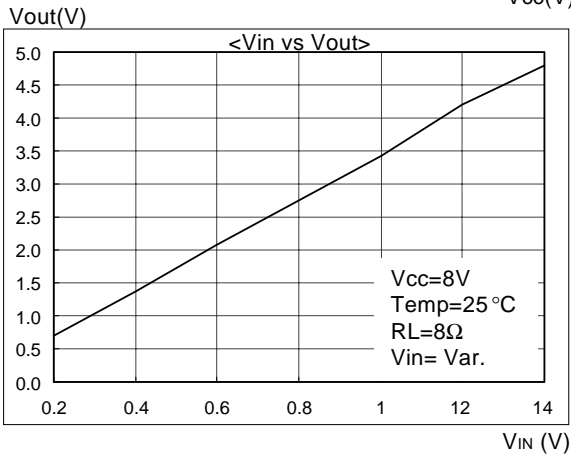
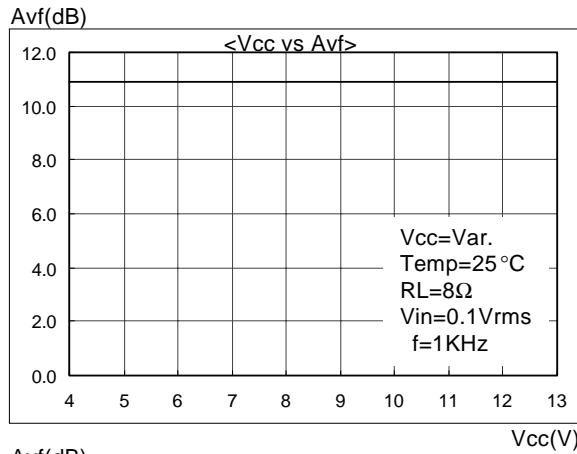
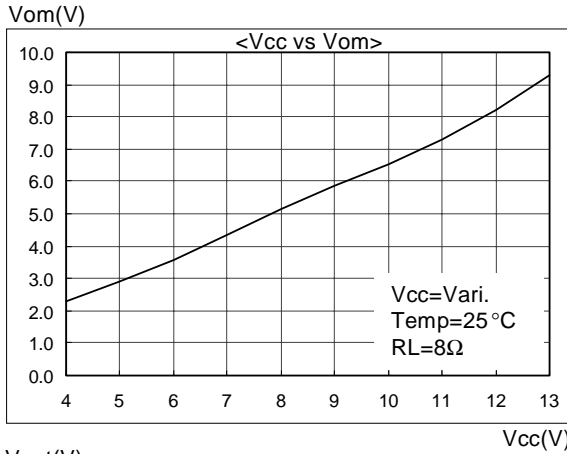

Typical Performance Characteristics (Continued)

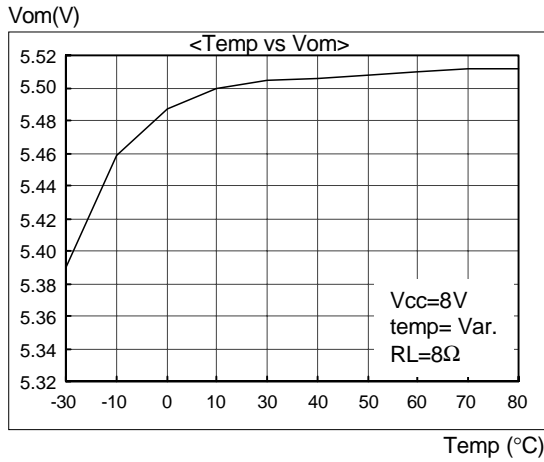

Tray drive part

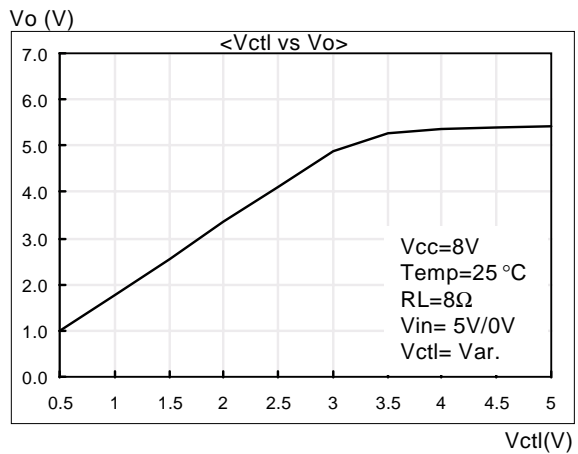
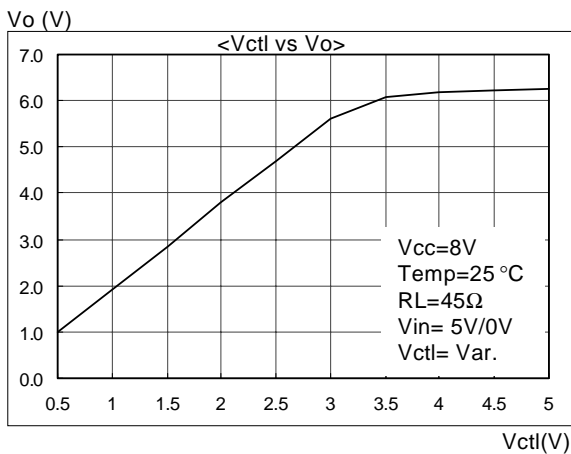
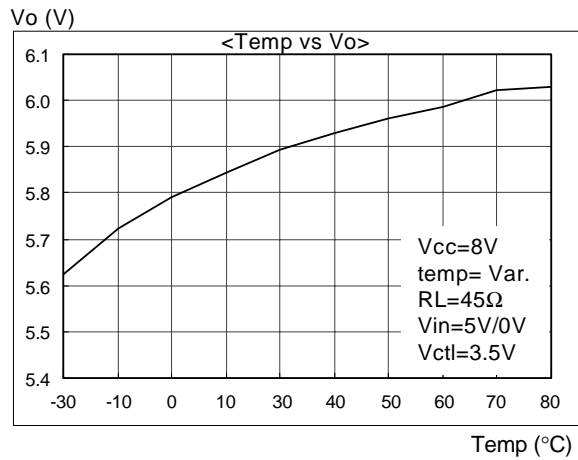
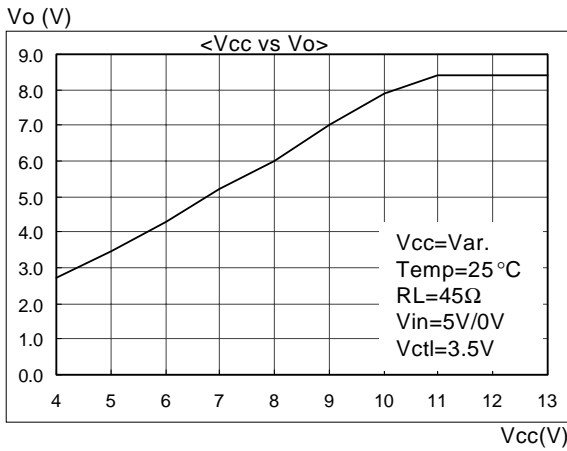

Typical Performance Characteristics (Continued)

Regulator part

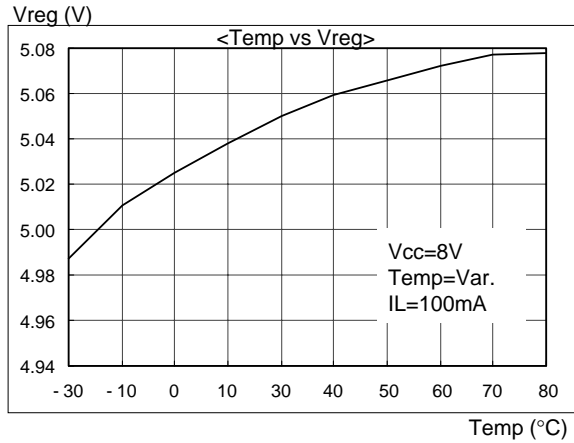
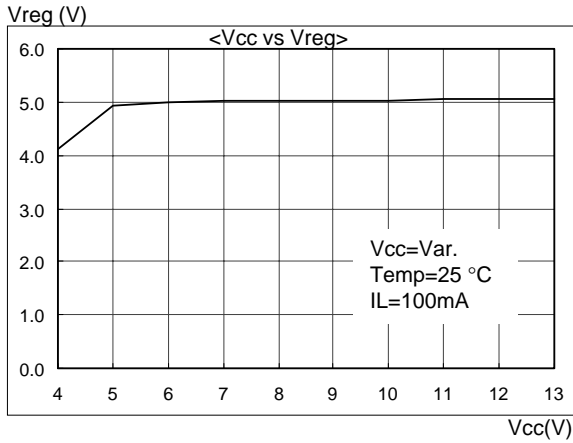

Normal Op Amp part

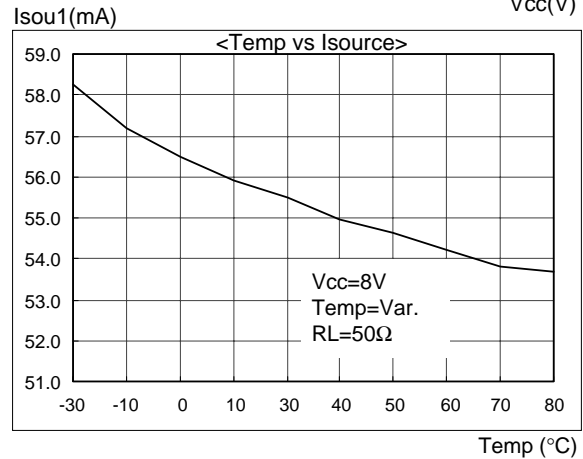
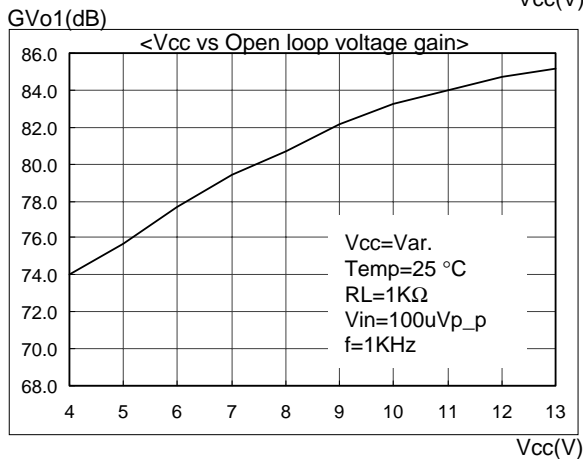
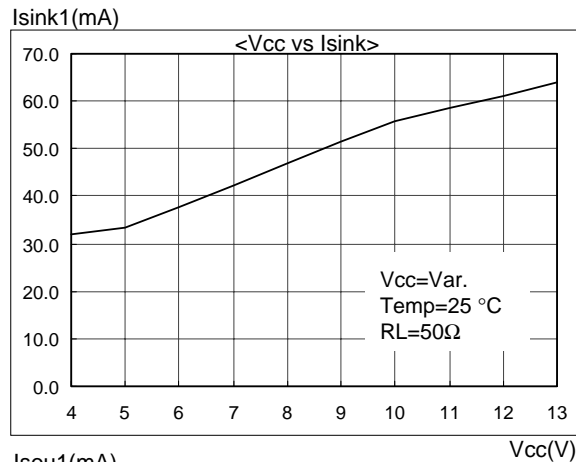
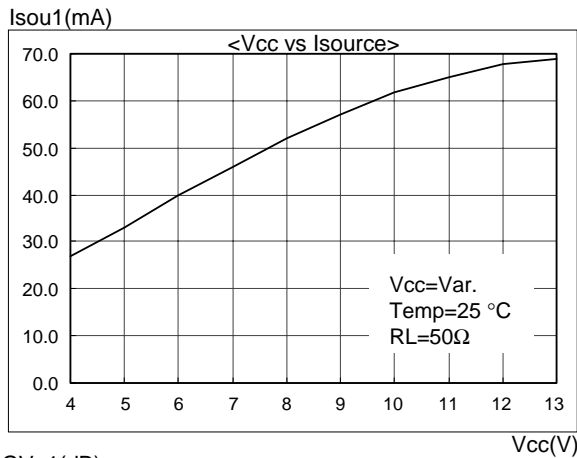

Typical Performance Characteristics (Continued)

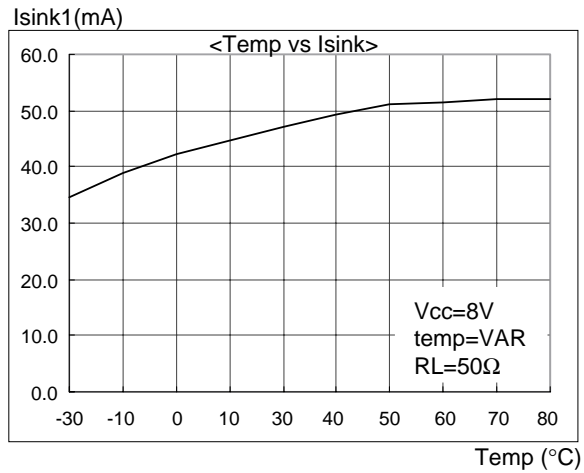

Input Op Amp part

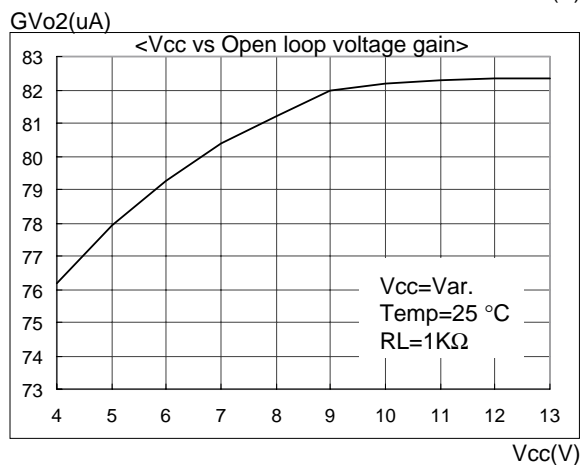
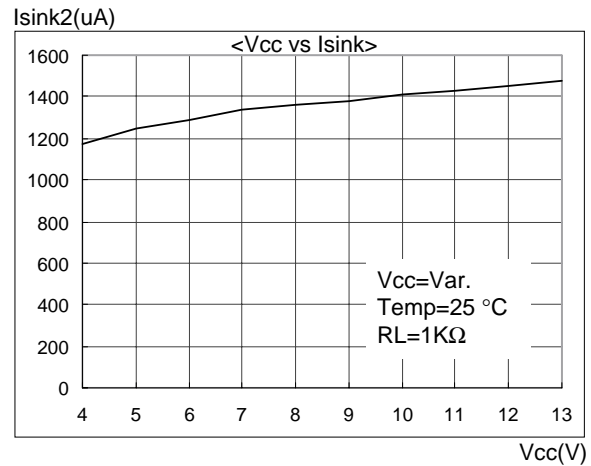
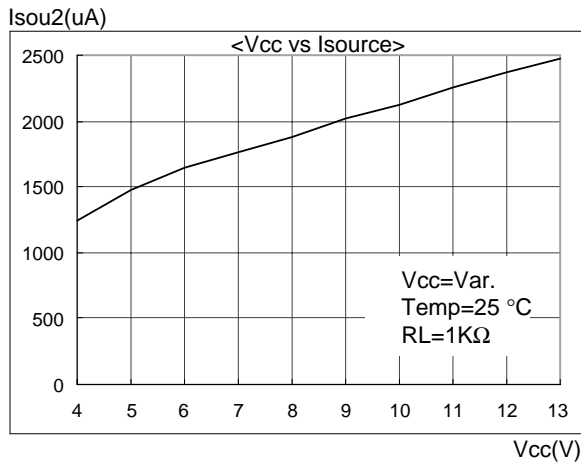

Test Circuits

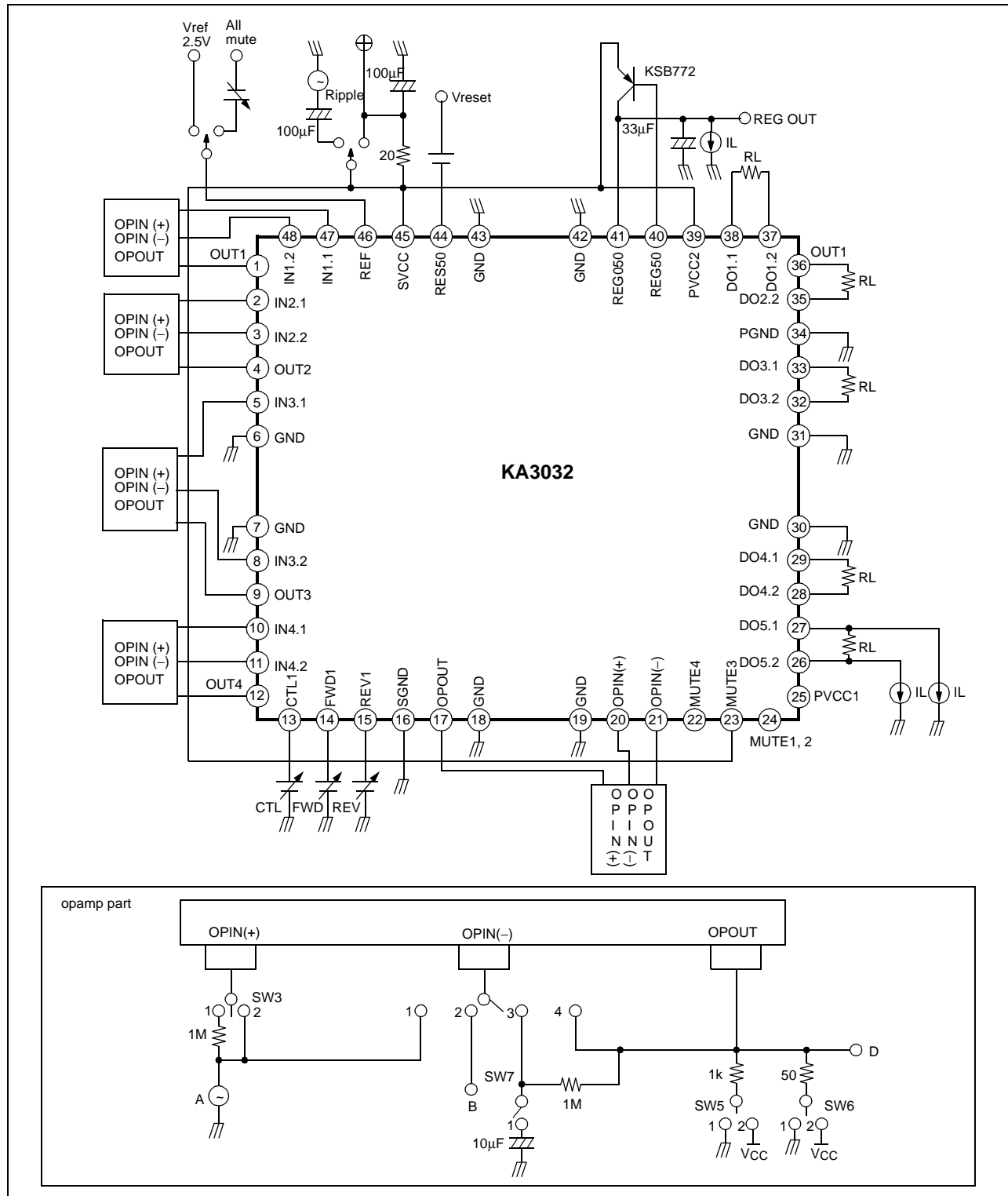

Application Circuits

(Voltage Mode Control)

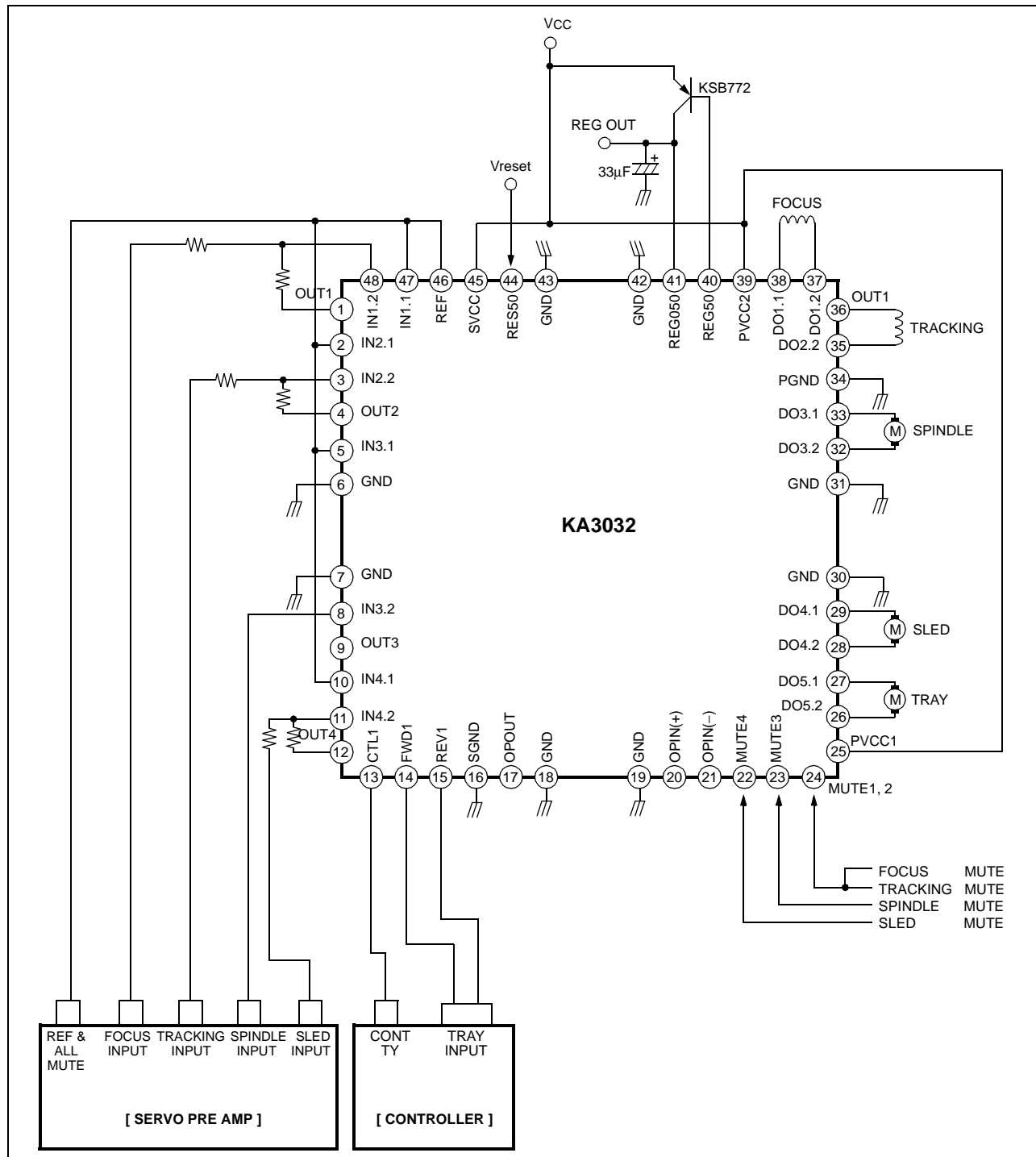

Notes:

CONT: Controller
 TY: Tray

Application Circuits

(Differential mode control)

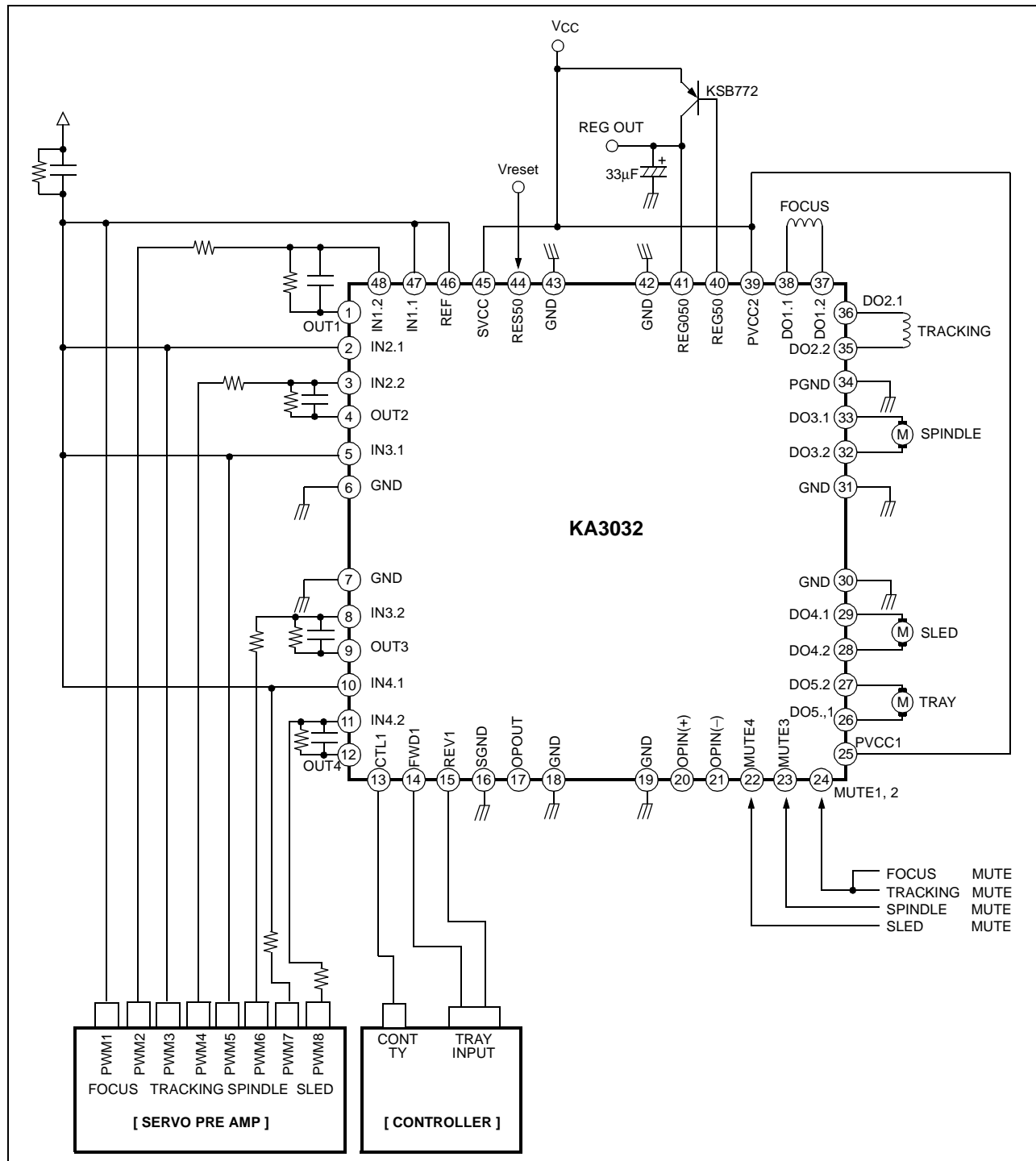

LIFE SUPPORT POLICY

FAIRCHILD'S PRODUCTS ARE NOT AUTHORIZED FOR USE AS CRITICAL COMPONENTS IN LIFE SUPPORT DEVICES OR SYSTEMS WITHOUT THE EXPRESS WRITTEN APPROVAL OF THE PRESIDENT OF FAIRCHILD SEMICONDUCTOR INTERNATIONAL. As used herein:

1. Life support devices or systems are devices or systems which, (a) are intended for surgical implant into the body, or (b) support or sustain life, and (c) whose failure to perform when properly used in accordance with instructions for use provided in the labeling, can be reasonably expected to result in a significant injury of the user.
2. A critical component in any component of a life support device or system whose failure to perform can be reasonably expected to cause the failure of the life support device or system, or to affect its safety or effectiveness.