

RoHS

K78UXX-500(L) Series

WIDE INPUT NON-ISOLATED & REGULATED SINGLE OUTPUT

FEATURES

- Efficiency up to 95%
- Ultra wide input voltage range can up to 8:1
- Operating temperature: -40°C ~ +85°C
- Pin-out compatible with LM78XX Linear
- Short circuit protection, thermal shutdown
- Low ripple and noise
- Micro miniature SIP package, meet UL94-V0 requirement
- No heatsink required
- Industry standard pinout
- MTBE>2,000,000Hours

APPLICATIONS

The K78UXX-500(L) series high efficiency switching regulators are ideally suited to replace LM78xx linear regulators and are pin compatible. It has ultra wide input voltage range, the efficiency of up to 95% means that very little energy is wasted as heat so there is no need for any heatsinks with their additional space and mounting costs.

MODEL SELECTION

K78U05-500

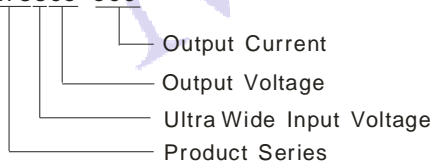

MORNSUN Science & Technology Co.,Ltd.

Address: No. 5, Kehui St. 1, Kehui development center, Science Ave., Guangzhou Science City, Luogang district, Guangzhou, P.R.China.

Tel: 86-20-28203030

Fax: 86-20-28203068

[Http://www.mornsun-power.com](http://www.mornsun-power.com)

PRODUCT PROGRAM

Part Number	Input Voltage(VDC)		Output			Efficiency%(typ.)	
	Nominal	Range	Voltage (VDC)	Current(mA) Min. Max.	Vin (Min.)	Vin (Max.)	
K78U03-500(L)	48	9.0~72.0	3.3	10 500	82	75	
K78U05-500(L)		9.0~72.0	5.0	10 500	87	81	
K78U06-500(L)		9.0~72.0	6.5	10 500	91	84	
K78U09-500(L)		14.0~72.0	9.0	10 500	92	86	
K78U12-500(L)		17.0~72.0	12.0	10 500	93	89	
K78U15-500(L)		20.0~72.0	15.0	10 500	94	90	
K78U24-300(L)		36.0~72.0	24.0	6 300	95	91	

Note: Add suffix "L" for 90° bend pins, for example: K78U05-500L.

OUTPUT SPECIFICATIONS

Item	Test conditions	Min.	Typ.	Max.	Units
Output voltage accuracy	100% full load		±2	±3	%
Line regulation	Vin=min. to max. at full load		±0.4	±1.0	
Load regulation*	From 10% to 100% Load		±0.3	±0.6	
Ripple & Noise	20MHz bandwidth, from 10% to 100% Load (refer to figure 2)		20	60	mVp-p
Short circuit input power	Vin=Nominal		0.72	1.2	W
Short circuit protection		Continuous, automatic			
Thermal shutdown			160		°C
Switching frequency	100% full load	120		800	kHz
Output current limit	Vin=Nominal		700	1200	mA
Quiescent current	Vin=Nominal, Min. Load		1	5	
Temperature coefficient	-40°C ~ +85°C ambient			±0.015	%/°C
Tendencies load	From 10% to 100% Load		1.0	1.5	ms
Max capacitance load				100	µF

Note: "GND" Pin can not vacant, or it will damage the module.

COMMON SPECIFICATIONS

Item	Test conditions	Min.	Typ.	Max.	Units
Storage humidity				95	%
Operating temperature	Power derating (above 71°C)	-40		85	°C
Operating case temp.			65	100	
Storage temperature		-55		125	
Lead temperature	1.5mm from case for 10 seconds			300	
Cooling		Free Air Convection			
Case material		Plastic (UL94-V0)			
MTBF	25°C (MIL-HDBK-217F)	3500			k hours
	71°C (MIL-HDBK-217F)	1500			
Hop swap		Not supported			
Thermal resistance				60	°C/W
EMI conducted	Refer to figure 5	EN55022, CLASS B			
RFI conducted					
Electrostatic discharge		IEC/EN 61000-4-2 level 4			
Safety approvals		EN-60950-1 standards			
Weight			4		g

TYPICAL CHARECTERISTICS

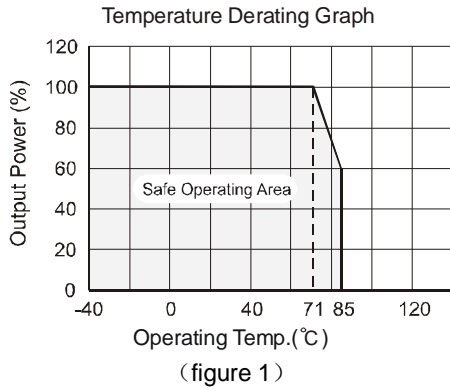

TYPICAL APPLICATION CIRCUIT

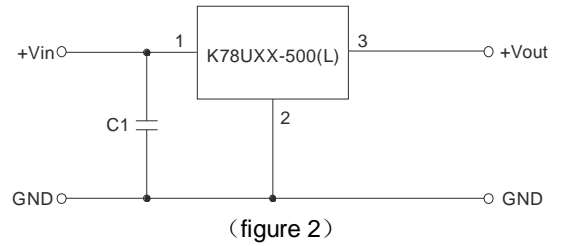

Note:

1. The regulator proposed to establish the input voltage by soft-start, no plug and play, if the input voltage changes from low voltage to high voltage abruptly, the regulator might be damaged.
2. If the applications is high-voltage input, the regulator must add an external capacitor C1($\leq 47\mu\text{F}/100\text{V}$),to prevent voltage spikes caused by damage to the module.
3. No parallel connection.

APPLICATION EXAMPLE

High voltage input, Multiple Outputs, with greater load

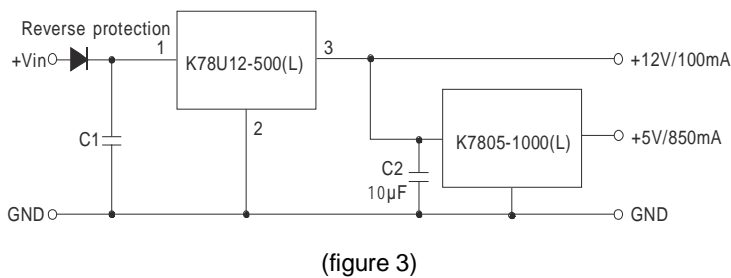

Note:

1. the input current amount of the back-grade regulator and the pre-class load should be less than or equal the max load current of the pre-class regulator.
2. If further filtering is required, please add components as per the above circuit(We recommend not to add components), if request, please make sure the capacitors C1 $\leq 47\mu\text{F}$, C2 $\leq 10\mu\text{F}$ more close to the back-grade regulator.

MODULES PROTECT RECOMMENDED CIRCUIT

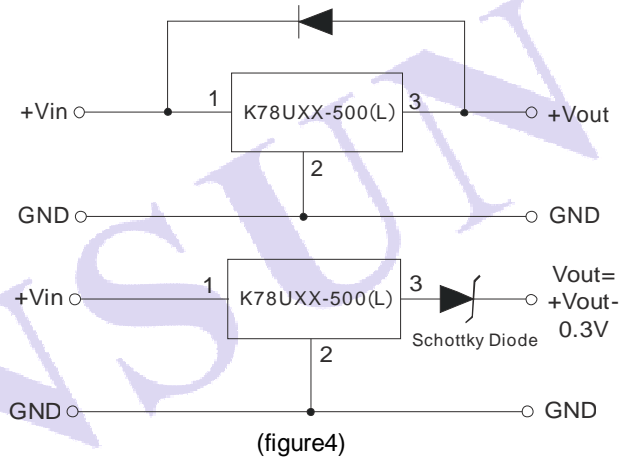

EMC RECOMMENDED CIRCUIT

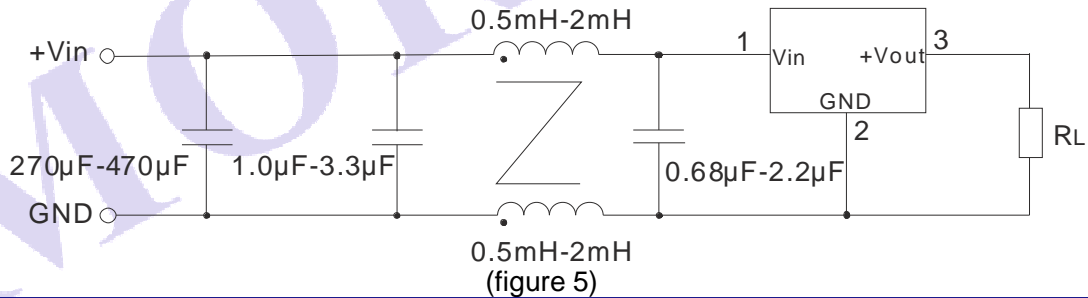

TEST CONFIGURATIONS (TA=25°C)

1、 FULL LOAD OUTPUT RIPPLE & NOISE MEASURED GRAPH

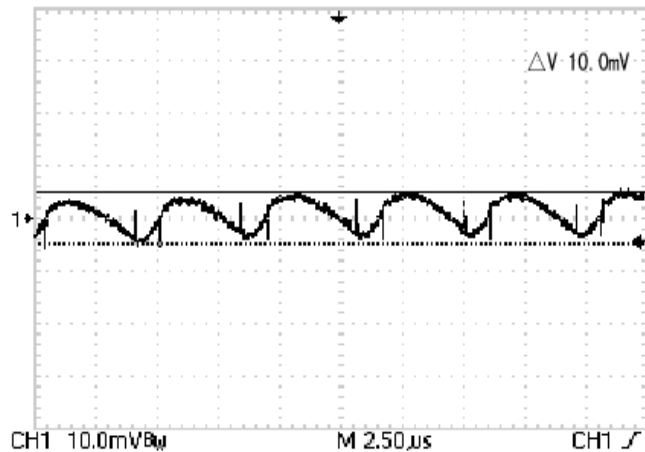

(figure 6)

2、 LOAD TRANSIENT RESPONSE WAVEFORM

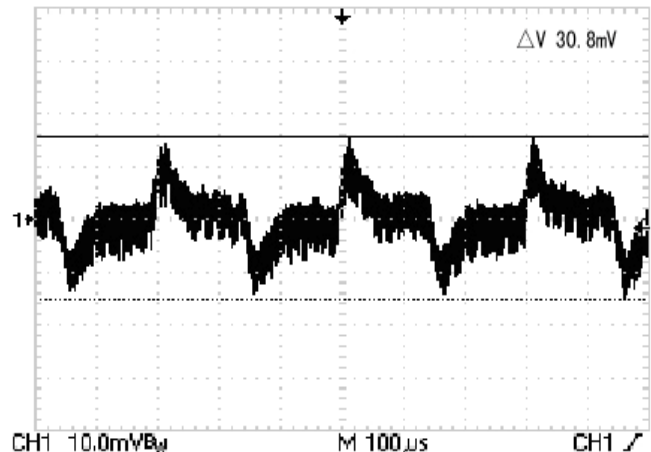

(figure 7)

CHARACTERISTICS CURVE

Efficiency

Ripple

Efficiency VS Input Voltage curve (full Load)

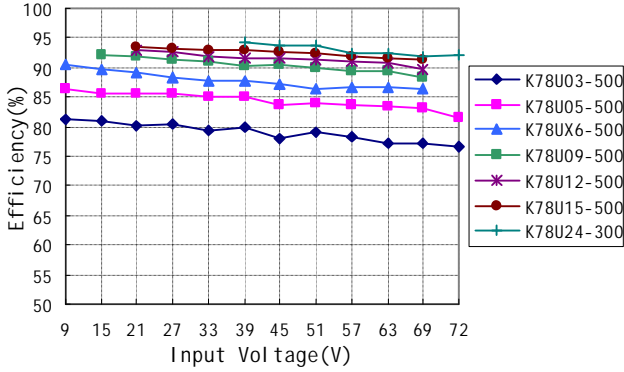

Ripple VS Load curve (Vin=Vmax)

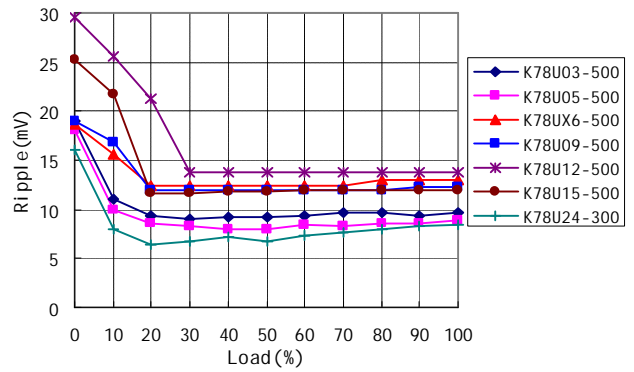

Efficiency VS Load curve (Vin=Vin-nominal)

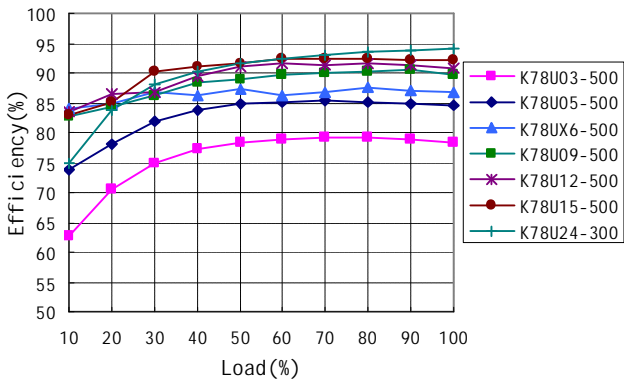

Ripple VS Load curve (Vin=Vin-nominal)

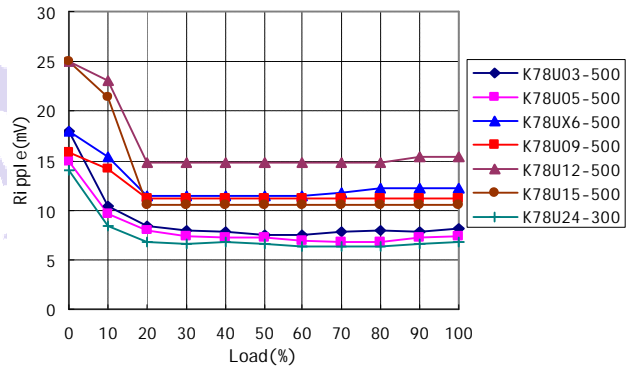

Efficiency VS Load curve (Vin=Vmin)

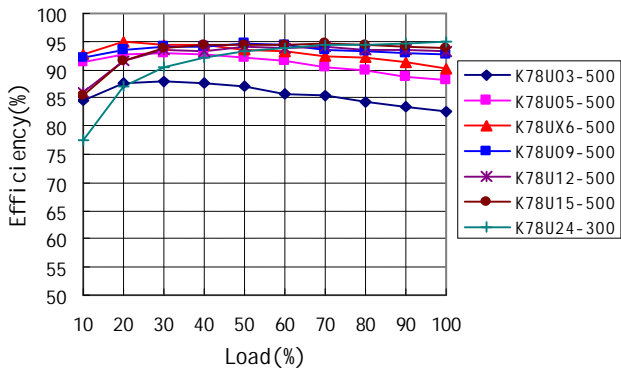

Ripple VS Load curve (Vin=Vmin)

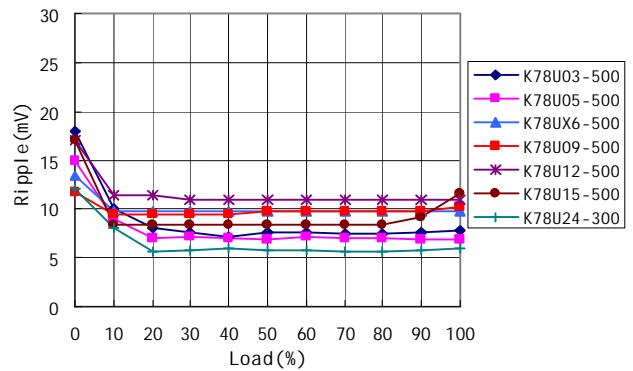

OUTLINE DIMENSIONS & FOOTPRINT DETAILS

MECHANICAL DIMENSIONS

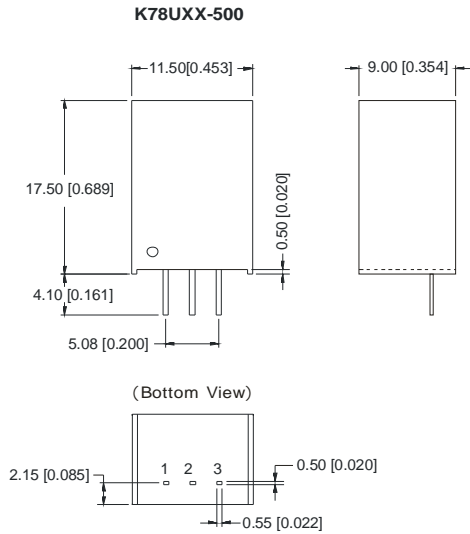

Note:
Unit: mm[inch]
Pin section tolerances: $\pm 0.10\text{mm}[\pm 0.004\text{inch}]$
General tolerances: $\pm 0.25\text{mm}[\pm 0.010\text{inch}]$

K78UXX-500L

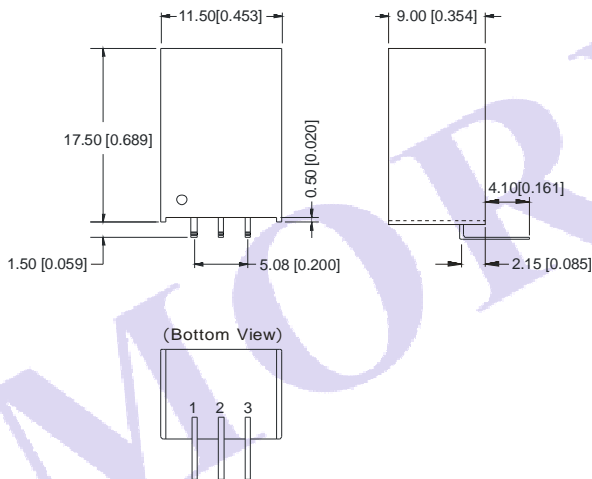

Note:
Unit: mm[inch]
Pin section tolerances: $\pm 0.10\text{mm}[\pm 0.004\text{inch}]$
General tolerances: $\pm 0.50\text{mm}[\pm 0.020\text{inch}]$

RECOMMENDED FOOTPRINT

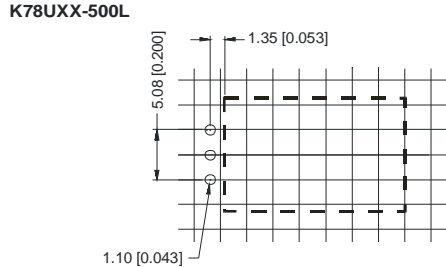
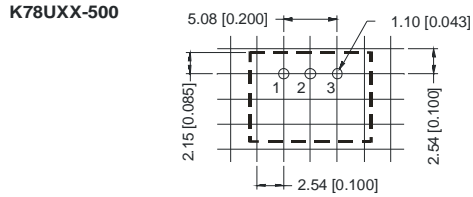

FOOTPRINT DETAILS	
pin	Function
1	+Vin
2	GND
3	+Vout

TUBE OUTLINE DIMENSIONS

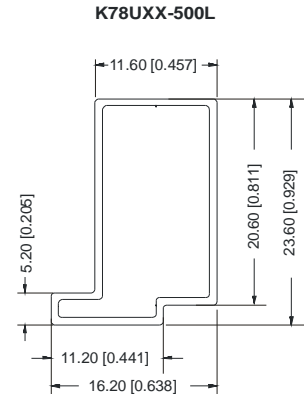
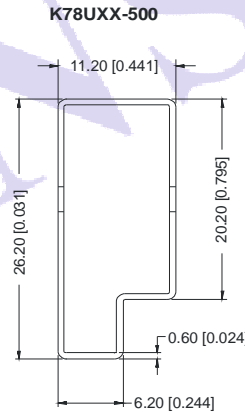

Note:
Unit: mm[inch]
General tolerances: $\pm 0.50\text{mm}[\pm 0.020\text{inch}]$
L=530mm[20.866inch] Devices per tube quantity: 44pcs
L=220mm[8.661inch] Devices per tube quantity: 17pcs
Short tube inner packaging dimensions: L*W*H=255*170*80mm
Short tube outer packaging dimensions: L*W*H=375*280*270mm
Long tube inner packaging dimensions: L*W*H=580*200*100mm
Long tube outer packaging dimensions(with two inner packaging boxes): L*W*H=600*215*220mm
Long tube outer packaging dimensions(with two inner packaging boxes): L*W*H=600*215*325mm

Note:

1. The load shouldn't be less than 10%, and the output external capacitor should not be too large (recommend $<10\mu\text{F}$), otherwise ripple will increase dramatically.
2. Operation under 10% load will not damage the converter; However, they may not meet all specification listed
3. All specifications measured at $T_a=25^\circ\text{C}$, humidity $<75\%$, nominal input voltage and rated output load unless otherwise specified.
4. In this datasheet, all the test methods of indications are based on corporate standards.