

mm inch

FEATURES

- Low pick-up voltage for high ambient use
- Sealed construction
- Ultra-miniature size with universal footprint
- Usable at high temperature: 85°C 185°F

SPECIFICATIONS

Contact				Standard type		High capacity type					
Arrangement								1 Form A, 1 Form C			
Contact material								Silver alloy			
Initial contact resistance, max.* (By voltage drop 6 V DC 1 A)								200 mΩ		100 mΩ	
Initial voltage drop								Max. 0.2 V (at 10 A 12 V DC)			
Rating	Nominal switching capacity		10 A 16 V DC (resistive)		15 A 16 V DC (resistive)						
	Max. switching power		160 W								
	Max. switching voltage		16 V DC								
	Max. switching current		10 A		15 A (10 A max. at 85°C)						
Expected life (min. ope.)	Mechanical life (at 180 cpm)		10 ⁷								
	Electrical	Resistive	10 ⁵		N.O.: 10 ⁵ N.C.: 5×10 ⁴						

* Measured after operating 5 times at the rated load

Coil		
Nominal operating power	640 mW	

Contact rating				
Load	Standard type		High capacity type	
	Form A	Form C	Form A	Form C
Max. carry current	15 A	15 A	15 A	15 A
Max. make current	25 A	25 A	10 A	50 A
Max. break current	10 A	10 A	10 A	15 A

Characteristics		
Max. operating speed (at rated load)		15 cps.
Initial insulation resistance* ¹		Min. 100 MΩ (at 500 V DC)
Initial breakdown voltage* ²	Between open contacts	750 Vrms for 1 min.
	Between contacts and coil	1,500 Vrms for 1 min.
Operate time* ³ (at nominal voltage)		Approx. 10 ms
Release time (without diode)* ³ (at nominal voltage)		Approx. 10 ms
Shock resistance	Functional* ⁴	Min. 98 m/s ² {10 G}
	Destructive* ⁵	Min. 980 m/s ² {100 G}
Vibration resistance	Functional* ⁶	Approx. 98 m/s ² {10 G}, 10 to 55 Hz at double amplitude of 1.6 mm
	Destructive	Approx. 117.6 m/s ² {12 G}, 10 to 55 Hz at double amplitude of 2 mm
Conditions for operation, transport and storage* ⁷ (Not freezing and condensing at low temperature)	Ambient temp.	-40°C to +85°C -40°F to +185°F
	Humidity	5 to 85% R.H.
Unit weight		Approx. 12 g .423 oz

Remarks

- * Specifications will vary with foreign standards certification ratings.
- *¹ Measurement at same location as "Initial breakdown voltage" section
- *² Detection current: 10mA
- *³ Excluding contact bounce time
- *⁴ Half-wave pulse of sine wave: 11ms; detection time: 10μs
- *⁵ Half-wave pulse of sine wave: 6ms
- *⁶ Detection time: 10μs
- *⁷ Refer to 5. Conditions for operation, transport and storage mentioned in AMBIENT ENVIRONMENT (Page 61)

TYPICAL APPLICATIONS

- Automotive: Power-window, car antenna, door lock, intermittent wiper, interior lighting, power seat, power sunroof, car stereo power antenna, etc.

ORDERING INFORMATION

Ex. JSM 1a F — 12V — 4

Contact arrangement	Protective construction	Coil voltage (DC)	Contact material
1a: 1 Form A 1: 1 Form C	Nil: Sealed construction F: Flux-resistant type	9, 12 V	4: Standard type (10 A) 5: High capacity type (15 A)

Note: Standard packing: Carton: 100 pcs. Case: 500 pcs.

TYPES AND COIL DATA (at 20°C 68°F)

Contact arrangement	Coil voltage, V DC	Standard type (10 A)		High capacity type (15 A)		Nominal voltage, V DC	Pick-up voltage, V DC (max.)	Drop-out voltage, V DC (min.)	Coil resistance Ω ($\pm 10\%$)	Nominal operating current, mA ($\pm 10\%$)	Nominal operating power, mW	Max. allowable voltage, V DC (at 80°C 176°F)
		Sealed type	Flux-resistant type	Sealed type	Flux-resistant type							
1 Form A	9	JSM1a-9V-4	JSM1aF-9V-4	JSM1a-9V-5	JSM1aF-9V-5	9	4.7	0.7	126	71.4	640	12
	12	JSM1a-12V-4	JSM1aF-12V-4	JSM1a-12V-5	JSM1aF-12V-5	12	6.3	0.9	225	53.3	640	16
1 Form C	9	JSM1-9V-4	JSM1F-9V-4	JSM1-9V-5	JSM1F-9V-5	9	4.7	0.7	126	71.4	640	12
	12	JSM1-12V-4	JSM1F-12V-4	JSM1-12V-5	JSM1F-12V-5	12	6.3	0.9	225	53.3	640	16

DIMENSIONS

mm inch

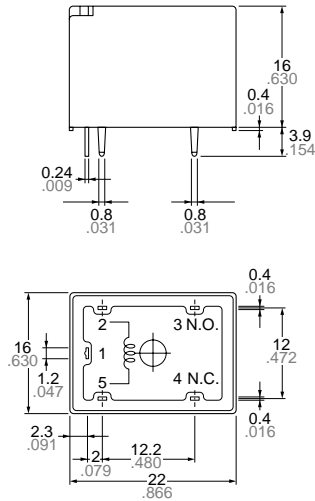
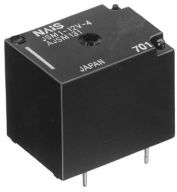

Note: Terminal No. 4 is only for 1 Form C type

General tolerance: $\pm 0.3 \pm 0.12$

Schematic (Bottom view)

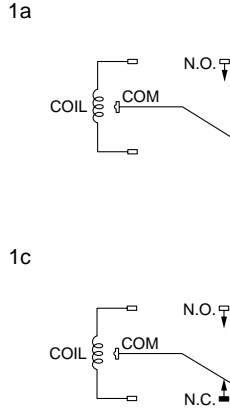

PC board pattern (Copper-side view)

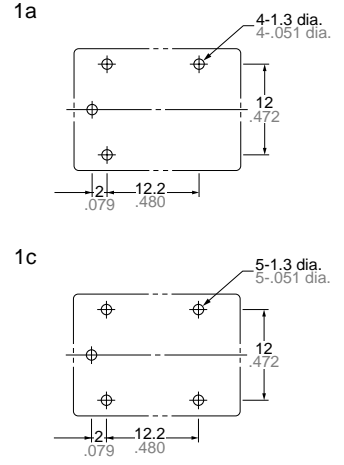

Tolerance: $\pm 0.1 \pm 0.004$

REFERENCE DATA

1-(1) Electrical life test (Resistive)

Tested sample: JSM-12V-4, 3 pcs.
Condition: 10 A 16 V DC resistive load, 20 cpm
Ambient temperature: 25°C 77°F

Circuit

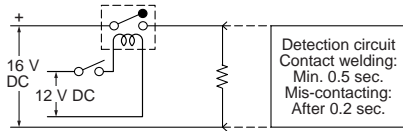

Change of pick-up and drop-out voltage

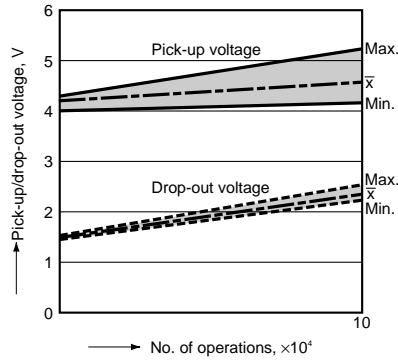

Change of contact resistance

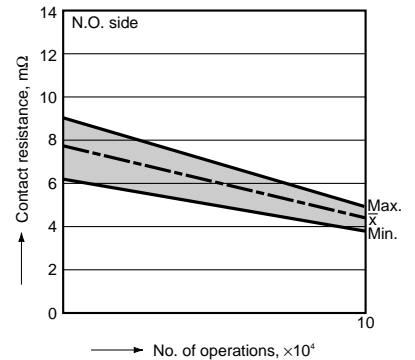

1-(2) Electrical life test

(Power window motor load)

Tested sample: JSM1-12V-4, 4 pcs.
Load: DC 14 V
(1) Max. 14.8 A (Inrush) Max. 14.2 A (Break)
(2) Max. 20.3 A (Inrush) Max. 20.0 A (Break)
(3) Max. 16.2 A (Inrush) Max. 11.6 A (Break)
Switching frequency: 3 cycle/min. (ON:OFF = 1:9 s)
Ambient temperature: (1) 85°C 185°F;
(2) -40°C -40°F; (3) 35°C 95°F
Tested cycle: (1) 2×10^4 cycle \rightarrow (2) 2×10^4 cycle \rightarrow
(3) 11×10^4 cycle (Total 15×10^4 cycles)

Circuit

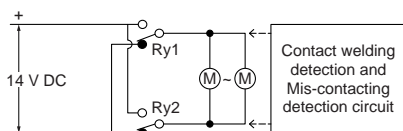

Change of pick-up and drop-out voltage

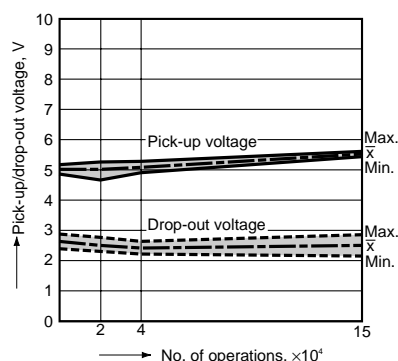

Change of contact resistance

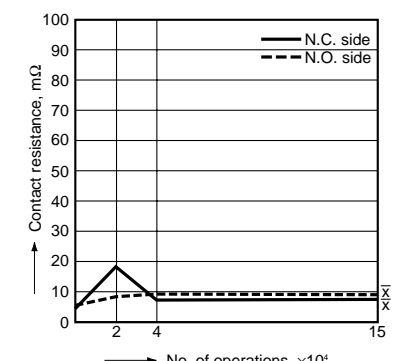

JS-M

1-(3) Electrical life test (Door lock motor load)

Tested sample: JSM1-12V-4, 10 pcs.
 Load: DC 16 V Max. 17.7 A, Min. 15.2 A
 Switching frequency: 6 cycles/min.
 (ON:OFF = 0.5:0.5 s)
 Ambient temperature: 30°C 86°F
 Tested cycle: 4×10^4 cycles

Circuit

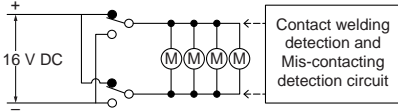

Change of pick-up and drop-out voltage

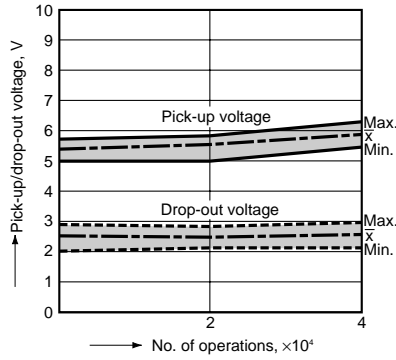

Change of contact resistance

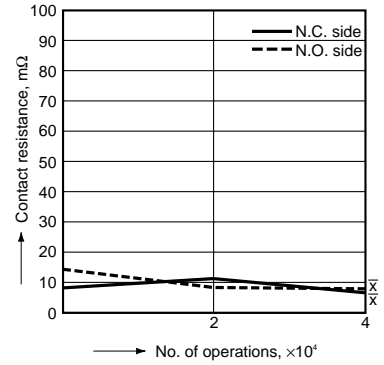

1-(4) Electrical life test

Tested sample: JSM1-12V-4, 3 pcs.
 Load: 16 V DC 25 A/5 A motor load
 Switching frequency: 6 cycles
 (ON:OFF = 1:9 s)
 Ambient temperature: 27°C 81°F

Circuit

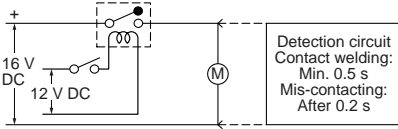

Change of pick-up and drop-out voltage

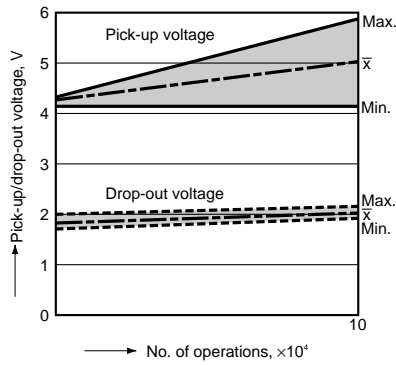

Change of contact resistance

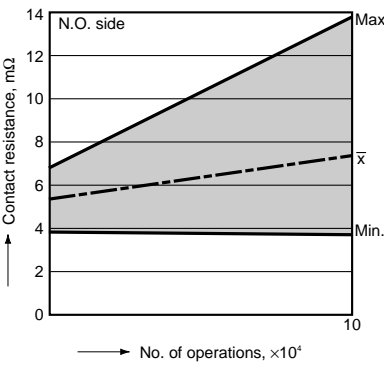

1-(5) Electrical life test

Tested sample: JSM1-12V-5, 4 pcs.
 Load: 16 V DC 15 A (resistive)
 Switching frequency: 20 cpm
 Ambient temperature: 25°C 77°F

Circuit

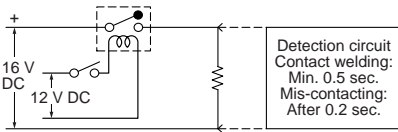

Change of pick-up and drop-out voltage

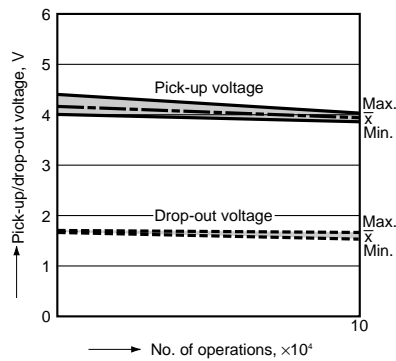

Change of contact resistance

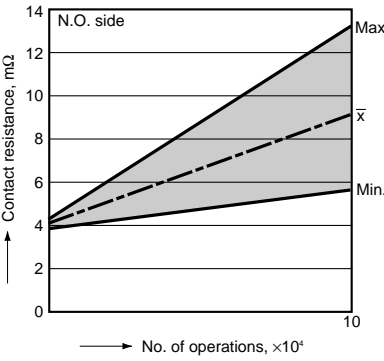

1-(6) Electrical life test

Tested sample: JSM1-12V-5, 3 pcs.
 Load: 16 V DC 50 A/10 A motor load
 Switching frequency: 6 cycles
 (ON:OFF = 1:9 s)
 Ambient temperature: 27°C 81°F

Circuit

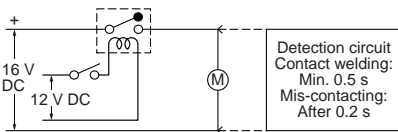

Change of pick-up and drop-out voltage

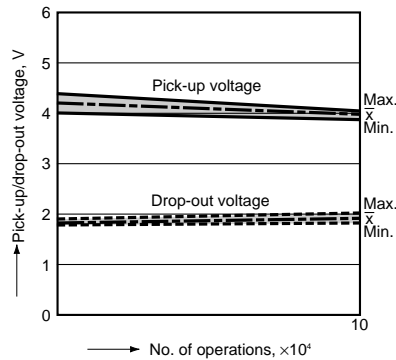

Change of contact resistance

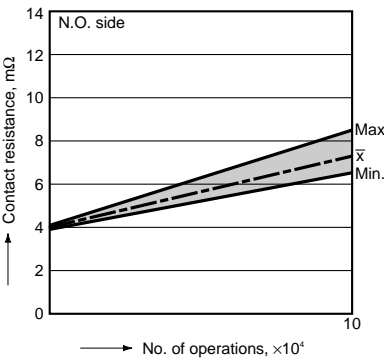

1-(7) Electrical life test (Lamp load)

Tested sample: JSM1a-12V-5, 4 pcs.
 Load: 9.6A Steady, Inrush 55.2A,
 14.5V DC (Lamp load)
 Operating frequency: ON 1s, OFF 2s

Circuit

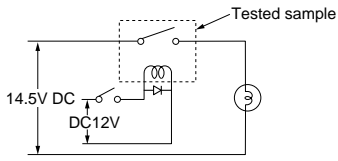

Contact welding: 0 time
 Miscontact: 0 time

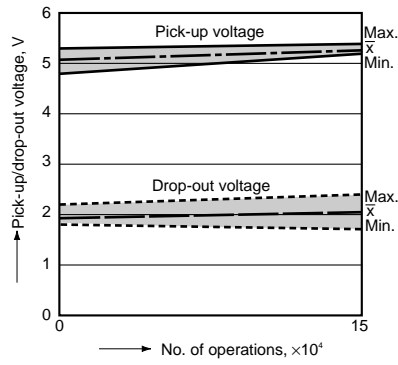

2. Temperature rise

Tested sample: JSM1-12V-4 & -5, 5 pcs.
 Measured portion: Inside the coil

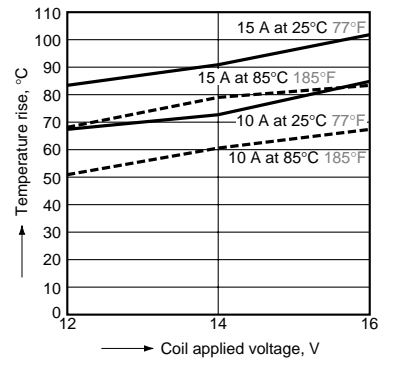

For Cautions for use, see Relay Technical Information (Page 48 to 76).