

**IZ0065**

**40 Channel Segment / Common Driver For Dot Matrix LCD**

The IZ0065 is a LCD driver LSI which is fabricated by low power CMOS technology. Basically this LSI consists of  $20 \times 2$  bit bi-directional shift register,  $20 \times 2$  bit data latch and  $20 \times 2$  bit driver. This LSI can be used a common or segment driver.

**FEATURES**

- Display driving bias: static -1/5
- Power supply voltage:  $+5V \pm 10\%$ ,  $+3V \pm 10\%$
- Supply voltage for display:  $0 \sim -5V(V_{EE})$
- Interface

**FUNCTIONS**

- Dot matrix LCD driver with 40-channel output.
- Selectable function to use common/segment drivers simultaneously.
- Input / Output signal
  - output:  $20 \times 2$  channel waveform for LCD driving
  - input: - Serial display data and control pulse from the controller LSI.
- Bias voltage ( $V_1$ - $V_6$ )

driver(cascade connection)	controller
Other IZ0065	IZ0066 KS0066 HD44780 SED1278

- CMOS Process
- Bare chip available

**ABSOLUTE MAXIMUM RATING ( $T_a = 25^\circ C$ )**

Characteristic	Symbol	Value	Unit
Operating Voltage	$V_{DD}$	-0.3 ~ 7.0	V
Driver Supply Voltage	$V_{LCD}$	$V_{DD} - 13.5 \sim V_{DD} + 0.3$	V
Input Voltage 1	$V_{IN1}$	$- 0.3 \sim V_{DD} + 0.3$	V
Input Voltage 2 ( $V_1$ - $V_6$ )	$V_{IN2}$	$V_{DD} + 0.3 \sim V_{EE} - 0.3$	V
Operating Temperature	$T_{OPR}$	-30 ~ +85	$^\circ C$
Storage Temperature	$T_{STG}$	-55 ~ +125	$^\circ C$

Voltage greater than above may damage to then circuit.  
 $V_{EE}$ : connect protection resistor ( $220\Omega \pm 5\%$ )



**ELECTRICAL CHARACTERISTICS**

**DC characteristics** ( $V_{DD}=2.7\sim 5.5V$ ,  $V_{DD} - V_{EE} =3\sim 13V$ ,  $V_{SS}=0V$ ,  $T_a=-30 \sim +85^{\circ}C$ )

Characteristic	Symbol	Test Condition	Min	Max	Unit	Applicable pin
Operating Current *	$I_{DD}$	$f_{CL2}=400KHz$	-	1	mA	-
Supply Current *	$I_{EE}$	$f_{CL1}=1KHz$	-	10	$\mu A$	
Input High Voltage	$V_{IH}$	-	$0.7V_{DD}$	$V_{DD}$	V	CL1, CL2, DL1, DL2, DR1, DR2, SHL1, SHL2, M, FCS
Input Low Voltage	$V_{IL}$		0	$0.3V_{DD}$		
Input Leakage Current	$I_{LKG}$	$V_{IN}=0-V_{DD}$	-5	5	$\mu A$	
Output High Voltage	$V_{OH}$	$I_{OH} = -0.4mA$	$V_{DD}-0.4$	-	V	
Output Low Voltage	$V_{OL}$	$I_{OL} = +0.4mA$	-	0.4		
Voltage Descending	$V_{D1}$	$I_{ON}=0.1mA$ for one of SC1-SC40	-	1.1		$V(V_1-V_6)$ , SC(SC <sub>1</sub> -SC <sub>40</sub> )
	$V_{D2}$	$I_{ON}=0.5mA$ for each SC1-SC40	-	1.5		
Leakage Current	$I_V$	$V_{IH}= V_{DD}\sim V_{EE}$ (Output SC1-SC40:floating)	-10	10	$\mu A$	$V_1-V_6$

\*  $V_{DD}-V_{EE}=4V$

**AC characteristics** ( $V_{DD}=2.7\sim 5.5V$ ,  $V_{DD} - V_{EE} =3\sim 13V$ ,  $V_{SS}=0V$ ,  $T_a=-30 \sim +85^{\circ}C$ )







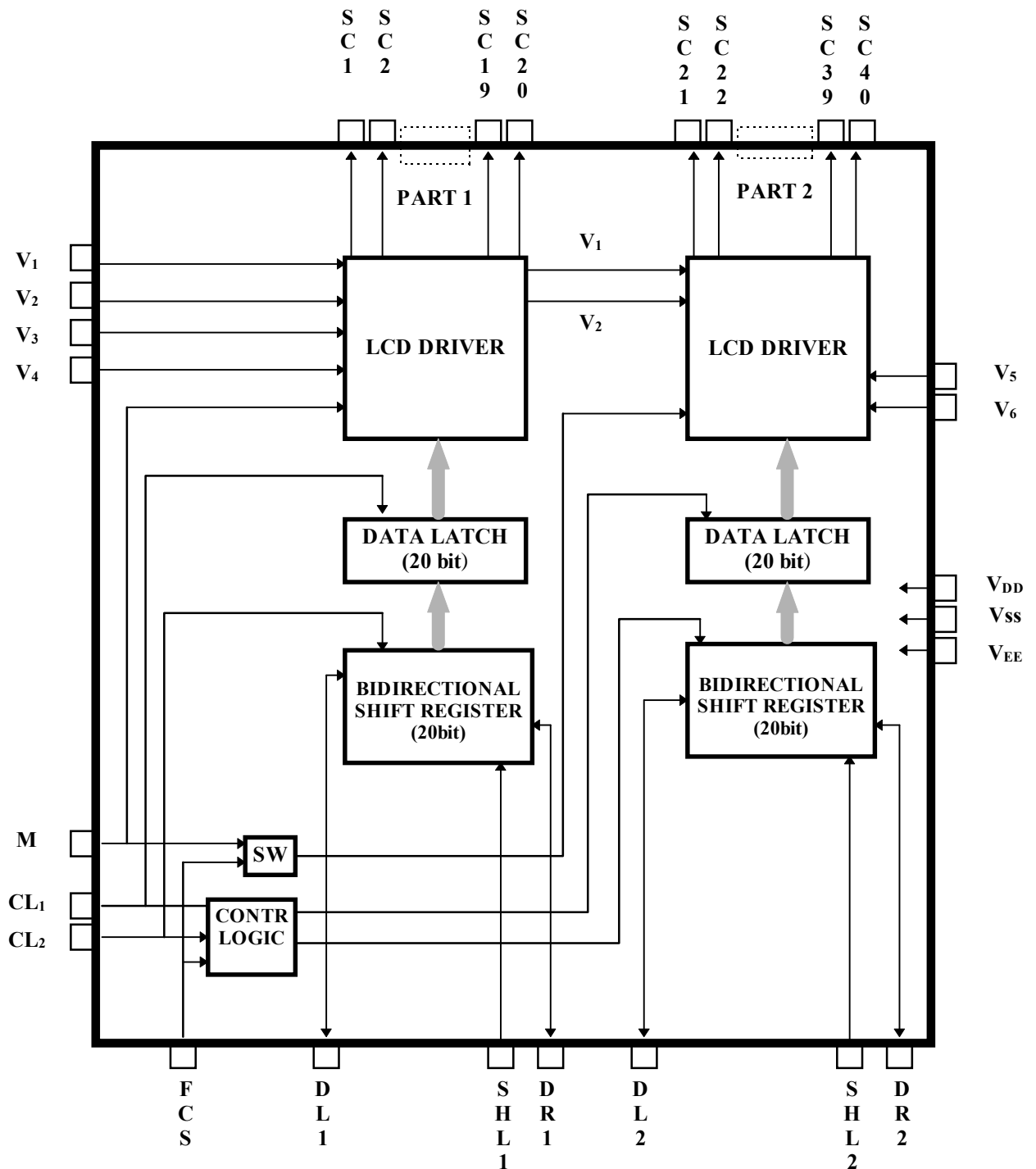





Characteristic	Symbol	Test Condition	Min	Max	Unit	Applicable pin
Data Shift Frequency	$f_{CL}$	-	-	400	KHz	CL2
Clock High Level Width	$t_{WCKH}$	-	800	-	ns	CL1, CL2
Clock Low Level Width	$t_{WCKL}$	-	800	-		CL2
Clock Set-up Time	$t_{LS}$	from CL2 to CL1	500	-		CL1, CL2
	$t_{LS}$	from CL1 to CL2	500	-		
Clock Rise/Fall Time	$t_R/t_F$	-	-	200		
Data Set-up Time	$t_{SU}$	-	300	-		DL1, DL2, DR1, DR2, FLM
Data Hold Time	$t_{DH}$	-	300	-		
Data Delay Time	$t_D$	CL=15pF	-	500		DL1, DL2, DR1, DR2

Input/Output current excluded; When input is at the intermediate level with CMOS, excessive current flows through the input circuit to the power supply, To avoid this, input level must be fixed at «H» or «L».

BLOCK DIAGRAM



**PIN DESCRIPTION**

PIN №	INP/OUTP	NAME	DESCRIPTION	INTER-FACE																					
V <sub>DD</sub> (24)	Power	Operating Voltage	For logical circuit (+5 V ± 10%, +3 V ± 10%)	Power Supply																					
GND (34)			0 V (GND)																						
V <sub>EE</sub> (31)		Negative Supply Voltage	For LCD driver circuit (-5 V)																						
V <sub>1</sub> V <sub>2</sub> (44,45)	Input	Bias Voltage	Bias voltage level for LCD drive (select level)	Power																					
SC <sub>1</sub> +SC <sub>20</sub>	Output	LCD driver	LCD driver output	LCD																					
V <sub>3</sub> V <sub>4</sub> (46,47)	Input	PART 1	Bias Voltage	Bias voltage level for LCD drive (nonselect level)	Power																				
SHL1 (41)	Input		Data interface	Selection of the shift direction of Part 1 shift register	V <sub>DD</sub> or V <sub>SS</sub>																				
			<table border="1"> <thead> <tr> <th>SHL1</th> <th>DL1</th> <th>DR1</th> </tr> </thead> <tbody> <tr> <td>V<sub>DD</sub></td> <td>out</td> <td>in</td> </tr> <tr> <td>V<sub>SS</sub></td> <td>in</td> <td>out</td> </tr> </tbody> </table>		SHL1	DL1	DR1	V <sub>DD</sub>	out	in	V <sub>SS</sub>	in	out												
SHL1	DL1		DR1																						
V <sub>DD</sub>	out	in																							
V <sub>SS</sub>	in	out																							
DL1,DR1 (35,36)	Input/Output	Data input/output of Part 1 shift register		Controller or IZ0065																					
SC <sub>21</sub> ÷ SC <sub>40</sub>	Output	LCD driver	LCD driver output																						
V <sub>5</sub> V <sub>6</sub> (48,49)	Input	PART 2	Bias Voltage	Bias voltage level for LCD drive (nonselect level)	Power																				
SHL2 (42)	Input		Data interface	Selection of the shift direction of Part 2 shift register	V <sub>DD</sub> or V <sub>SS</sub>																				
			<table border="1"> <thead> <tr> <th>SHL2</th> <th>DL2</th> <th>DR2</th> </tr> </thead> <tbody> <tr> <td>V<sub>DD</sub></td> <td>out</td> <td>in</td> </tr> <tr> <td>V<sub>SS</sub></td> <td>in</td> <td>out</td> </tr> </tbody> </table>		SHL2	DL2	DR2	V <sub>DD</sub>	out	in	V <sub>SS</sub>	in	out												
SHL2	DL2		DR2																						
V <sub>DD</sub>	out	in																							
V <sub>SS</sub>	in	out																							
DL2,DR2 (37,38)	Input/Output	Data input/output of Part 2 shift register		Controller or IZ0065																					
M (40)	Input	Alternated signal for LCD driver output	<table border="1"> <thead> <tr> <th>PART</th> <th>FCS</th> <th>CL1</th> <th>CL2</th> <th>M polarity</th> </tr> </thead> <tbody> <tr> <td rowspan="2">1</td> <td>V<sub>SS</sub></td> <td>latch clock</td> <td>shift clock</td> <td rowspan="2">M</td> </tr> <tr> <td>V<sub>DD</sub></td> <td>()</td> <td>()</td> </tr> <tr> <td rowspan="2">2</td> <td>V<sub>SS</sub></td> <td>shift clock</td> <td>latch clock</td> <td rowspan="2">-M</td> </tr> <tr> <td>V<sub>DD</sub></td> <td>()</td> <td>()</td> </tr> </tbody> </table> <p>Shift/latch clock of display data and polarity of M signal are changed by FCS signal. By setting FCS to V<sub>DD</sub> level , user can select the function that use Part 1 as segment driver and Part 2 as common driver simultaneously.</p>	PART	FCS	CL1	CL2	M polarity	1	V <sub>SS</sub>	latch clock	shift clock	M	V <sub>DD</sub>	(  )	(  )	2	V <sub>SS</sub>	shift clock	latch clock	-M	V <sub>DD</sub>	(  )	(  )	Controller
PART	FCS	CL1		CL2	M polarity																				
1	V <sub>SS</sub>	latch clock		shift clock	M																				
	V <sub>DD</sub>	(  )	(  )																						
2	V <sub>SS</sub>	shift clock	latch clock	-M																					
	V <sub>DD</sub>	(  )	(  )																						
CL1,CL2 (32,33)	Input	Data shift / latch clock																							
FCS (43)	Input	Mode selection																							
NC(39)			No connection pin	N.C																					





**PAD DIAGRAM**

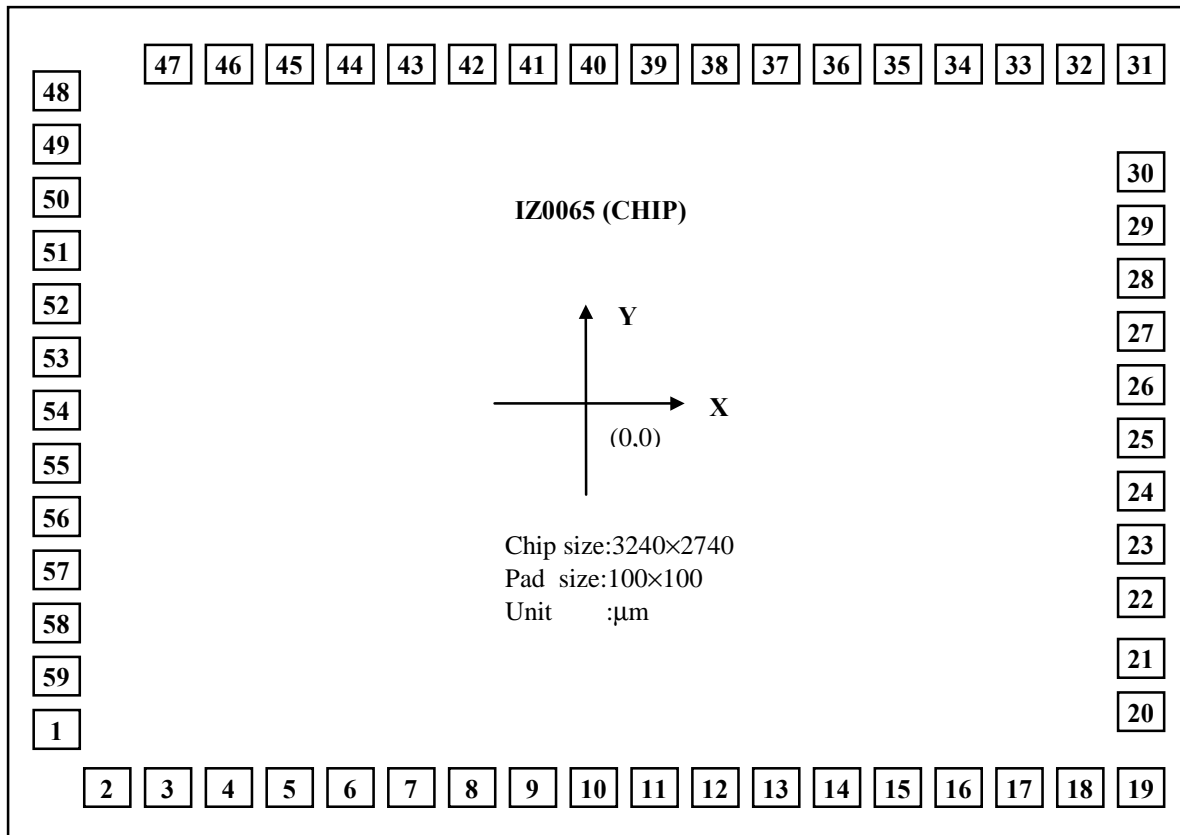

**PAD LOCATION**

Pad №	Pad Name	X	Y	Pad №	Pad Name	X	Y	Pad №	Pad Name	X	Y
1	VEE	-1384	-840	21	SC38	1381	-627.5	41	SC18	-185	1135
2	CL1	-1344	-1140	22	SC37	1381	-477.5	42	SC17	-335	1135
3	CL2	-1190	-1140	23	SC36	1381	-327.5	43	SC16	-485	1135
4	VSS	-1002	-1140	24	SC35	1381	-177.5	44	SC15	-635	1135
5	DL1	-852	-1140	25	SC30	1381	-29.5	45	SC14	-785	1135
6	DR1	-702	-1140	26	SC31	1381	120.5	46	SC13	-1033	1135
7	DL2	-552	-1140	27	SC32	1381	270.5	47	SC12	-1183	1135
8	DR2	-402	-1140	28	SC33	1381	420.5	48	SC9	-1384	970
9	M	-252	-1140	29	SC34	1381	570.5	49	SC10	-1384	820
10	SHL1	-102	-1140	30	SC29	1381	720.5	50	SC11	-1384	670
11	SHL2	48	-1140	31	SC28	1380	1135	51	SC8	-1384	520
12	FCS	198	-1140	32	SC27	1232	1135	52	SC7	-1384	370
13	V1	482	-1140	33	SC26	1082	1135	53	VDD	-1384	220
14	V2	632	-1140	34	SC25	932	1135	54	SC6	-1384	70
15	V3	782	-1140	35	SC24	782	1135	55	SC5	-1384	-80
16	V4	932	-1140	36	SC23	632	1135	56	SC4	-1384	-230
17	V5	1082	-1140	37	SC22	482	1135	57	SC3	-1384	-380
18	V6	1232	-1140	38	SC21	332	1135	58	SC2	-1384	-528
19	SC40	1382	-1140	39	SC20	115	1135	59	SC1	-1384	-678
20	SC39	1381	-777.5	40	SC19	-35	1135				

