

High and Low Side Driver

Features

- Gate drive supplies up to 20V per channel
- Undervoltage lockout for V_{CC} , V_{BS}
- 3.3 V, 5V, 15V input logic compatible
- Tolerant to negative transient voltage
- Designed for use with bootstrap power supplies
- Matched propagation delays
- Output in phase with the Inputs
- -40°C to 125°C operating range
- RoHS compliant

Description

The IRS2005 is a high voltage, high speed power MOSFET and IGBT driver with independent high and low side referenced output channels. Proprietary HVIC and latch immune CMOS technologies enable ruggedized monolithic construction. The logic input is compatible with standard CMOS or LSTTL output, down to 3.3V logic. The output drivers feature a high pulse current buffer stage designed for minimum driver cross-conduction. The floating channel can be used to drive an N-channel power MOSFET or IGBT in the high side configuration which operates up to 200 V. Propagation delays are matched to simplify the HVIC's use in high frequency applications.

Product Summary

V_{OFFSET}	$\leq 200\text{V}$
V_{OUT}	10 V – 20V
$I_{\text{o+}} \& I_{\text{o-}}$ (typ.)	290mA & 600mA
$t_{\text{ON}} \& t_{\text{OFF}}$ (typ.)	160ns & 150ns
Delay matching (max.)	50ns

Package Options

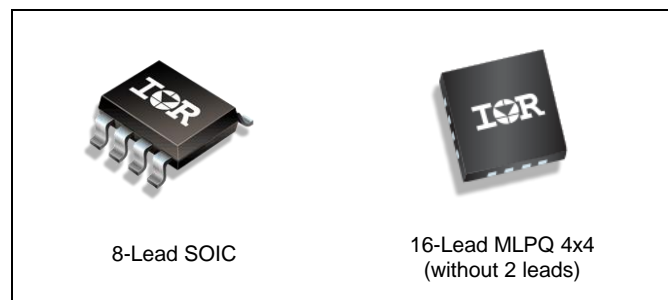

Typical Applications

- Appliance motor drives
- Servo drives
- Micro inverter drives
- General purpose three phase inverters

Base Part Number	Package Type	Standard Pack		Orderable Part Number
		Form	Quantity	
IRS2005SPBF	8-Lead SOIC	Tube/Bulk	95	IRS2005SPBF
		Tape and Reel	2500	IRS2005STRPBF
IRS2005MPBF	14-Lead MLPQ 4x4	Tape and Reel	3000	IRS2005MTRPBF

Typical Connection Diagram

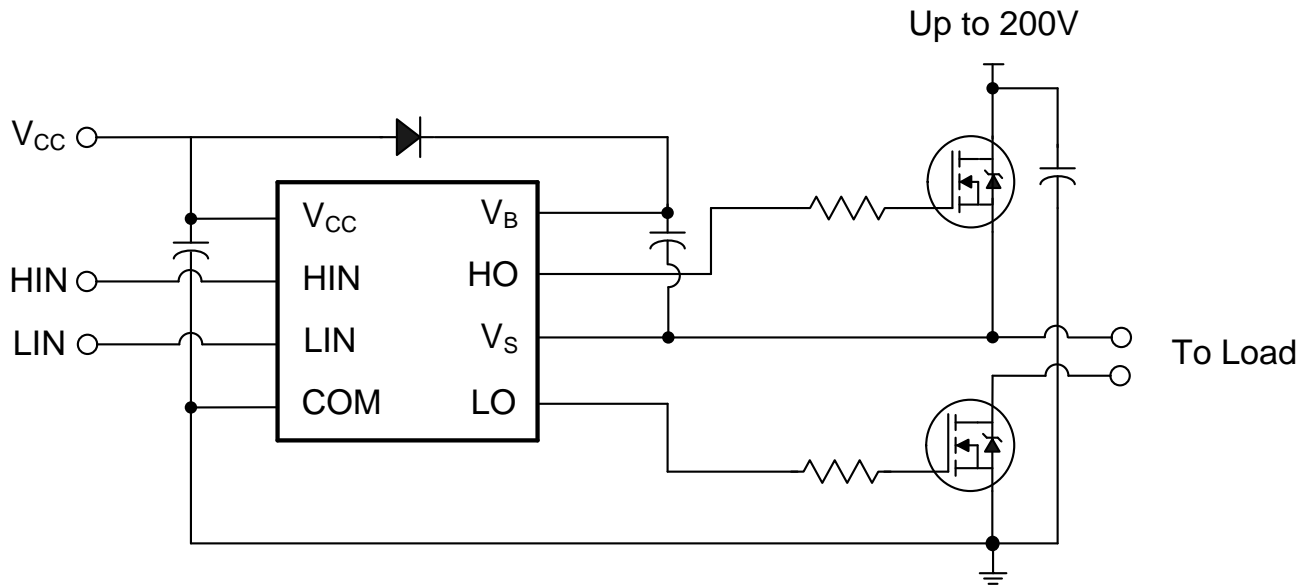

(Refer to Lead Assignments for correct pin configuration). This diagram shows electrical connections only. Please refer our Application Notes & DesignTips for proper circuit board layout.

Absolute Maximum Ratings

Absolute maximum ratings indicate sustained limits beyond which damage to the device may occur. All voltage parameters are absolute voltages referenced to COM unless otherwise stated in the table. The thermal resistance and power dissipation ratings are measured under board mounted and still air conditions.

Symbol	Definition	Min.	Max.	Units	
V _{CC}	Low side supply voltage	-0.3	25 [†]	V	
V _{IN}	Logic input voltage	COM - 0.3	V _{CC} + 0.3		
V _B	High-side floating well supply voltage	-0.3	225		
V _S	High-side floating well supply return voltage	V _B - 25	V _B + 0.3		
V _{HO}	Floating gate drive output voltage	V _S - 0.3	V _B + 0.3		
V _{LO}	Low-side output voltage	COM - 0.3	V _{CC} + 0.3		
COM	Power ground	V _{CC} - 25	V _{CC} + 0.3		
dV _S /dt	Allowable V _S offset supply transient relative to COM	—	50	V/ns	
P _D	Package power dissipation @ T _A ≤ +25°C	8-Lead SOIC	—	0.625	W
		14-Lead MLPQ 4x4	—	2.08	
R _{thJA}	Thermal resistance, junction to ambient	8-Lead SOIC	—	200	°C/W
		14-Lead MLPQ 4x4	—	36	
T _J	Junction temperature	—	150	°C	
T _S	Storage temperature	-55	150		
T _L	Lead temperature (soldering, 10 seconds)	—	300		

† All supplies are tested at 25V.

Recommended Operating Conditions

For proper operation, the device should be used within the recommended conditions. All voltage parameters are absolute voltages referenced to COM unless otherwise stated in the table. The offset rating is tested with supplies of (V_{CC} - COM) = (V_B - V_S) = 15V.

Symbol	Definition	Min	Max	Units
V _{CC}	Low-side supply voltage	10	20	V
V _{IN}	Logic input voltage	0	V _{CC}	
V _B	High-side floating well supply voltage	V _S + 10	V _S + 20	
V _S	High-side floating well supply offset voltage [†]	COM - 8 [†]	200	
V _{HO}	Floating gate drive output voltage	V _S	V _B	
V _{LO}	Low-side output voltage	COM	V _{CC}	
T _A	Ambient temperature	-40	125	°C

† Logic operation for V_S of -8 V to 200 V. Logic state held for V_S of -8 V to -V_{BS}. Please refer to Design Tip DT97-3 for more details.

Static Electrical Characteristics

$(V_{CC} - COM) = (V_B - V_S) = 15V$. $T_A = 25^\circ C$ unless otherwise specified. The V_{IN} and I_{IN} parameters are referenced to COM. The V_O and I_O parameters are referenced to respective V_S and COM and are applicable to the respective output leads HO or LO. The V_{CCUV} parameters are referenced to COM. The V_{BSUV} parameters are referenced to V_S .

Symbol	Definition	Min.	Typ.	Max.	Units	Test Conditions
V_{BSUV+}	V_{BS} supply undervoltage positive going threshold	8.0	8.9	9.8	V	
V_{BSUV-}	V_{BS} supply undervoltage negative going threshold	7.4	8.2	9		
V_{BSUVHY}	V_{BS} supply undervoltage hysteresis	—	0.7	—		
V_{CCUV+}	V_{CC} supply undervoltage positive going threshold	8.0	8.9	9.8		
V_{CCUV-}	V_{CC} supply undervoltage negative going threshold	7.4	8.2	9		
V_{CCUVHY}	V_{CC} supply undervoltage hysteresis	—	0.7	—		
I_{LK}	High-side floating well offset supply leakage	—	—	50	μA	$V_B = V_S = 200V$
I_{QBS}	Quiescent V_{BS} supply current	—	45	75		All inputs are in the off state
I_{QCC}	Quiescent V_{CC} supply current	—	300	520		
V_{OH}	High level output voltage drop, $V_{BIAS} - V_O$	—	0.05	0.2	V	$I_O = 2\text{ mA}$
V_{OL}	Low level output voltage drop, V_O	—	0.02	0.1		
I_{O+}	Output high short circuit pulsed current	200	290	—	mA	$V_O = 0V, V_{IN} = 0V$ $PW \leq 10\mu s$
I_{O-}	Output low short circuit pulsed current	420	600	—		$V_O = 15V, V_{IN} = 5V$ $PW \leq 10\mu s$
V_{IH}	Logic "1" input voltage	2.5	—	—	V	
V_{IL}	Logic "0" input voltage	—	—	0.8		
I_{IN+}	Input bias current (HO = High)	—	3	10	μA	$V_{IN} = 5V$
I_{IN-}	Input bias current (HO = Low)	—	—	5		$V_{IN} = 0V$

Dynamic Electrical Characteristics

$V_{CC} = V_B = 15V$, $V_S = COM$, $T_A = 25^\circ C$, and $C_L = 1000pF$ unless otherwise specified.

Symbol	Definition	Min.	Typ.	Max.	Units	Test Conditions
t_{ON}	Turn-on propagation delay	—	160	220	ns	$V_S = 0V$ or $200V$
t_{OFF}	Turn-off propagation delay	—	150	220		
t_R	Turn-on rise time	—	70	170		$V_S = 0V$
t_F	Turn-off fall time	—	30	90		
t_{FIL}	Minimum pulse input filter time	—	300	—		
MT	Delay matching time (t_{ON} , t_{OFF})	—	—	50		

Functional Block Diagram

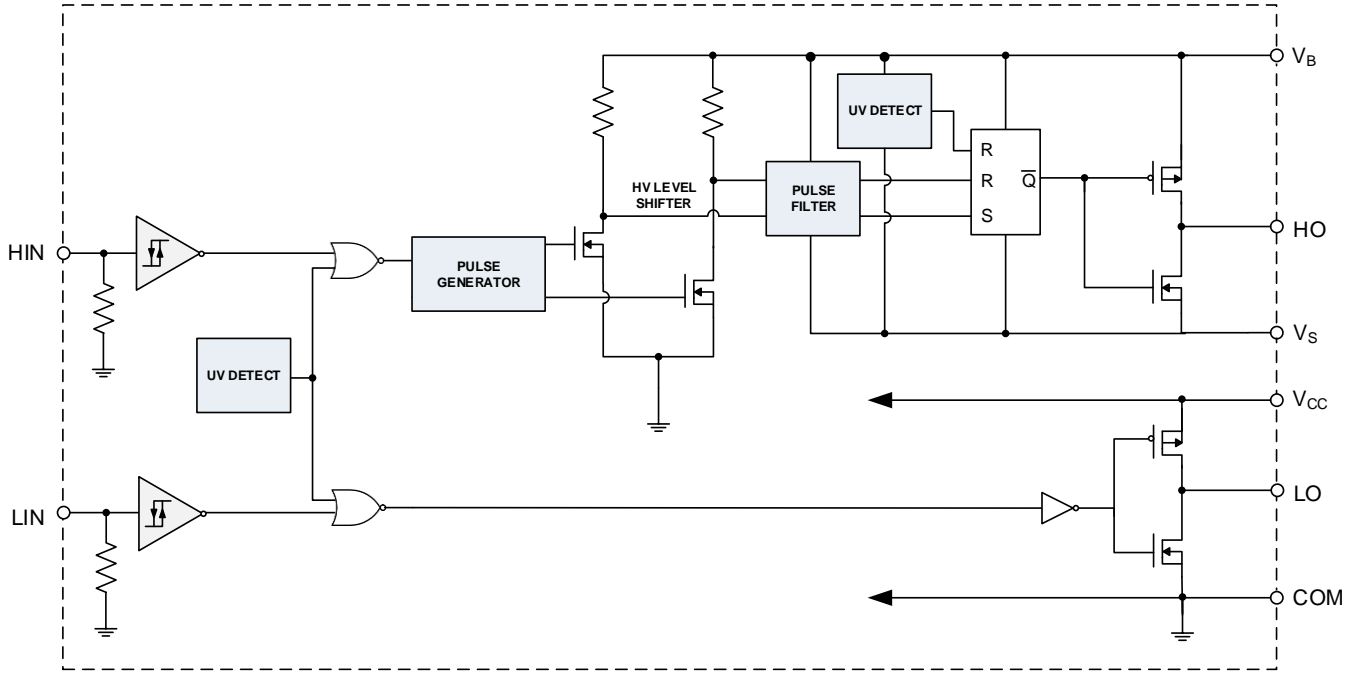

Lead Definitions

Symbol	Description
VCC	Low-side and logic supply voltage
VB	High-side gate drive floating supply
VS	High voltage floating supply return
HIN	Logic inputs for high-side gate driver output (HO), in phase
LIN	Logic inputs for low-side gate driver output (LO), in phase
HO	High-side driver output
LO	Low-side driver output
COM	Low-side gate drive return

Lead Assignments

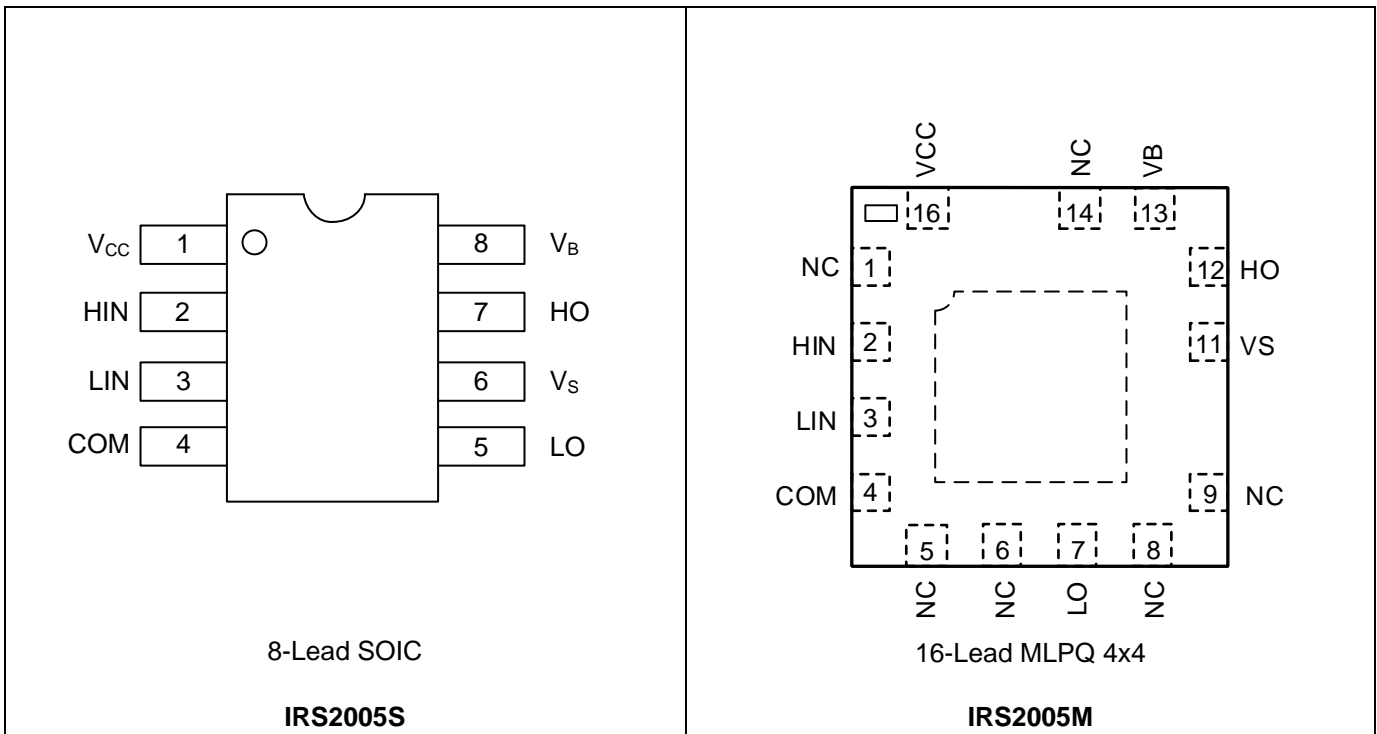

Application Information and Additional Details

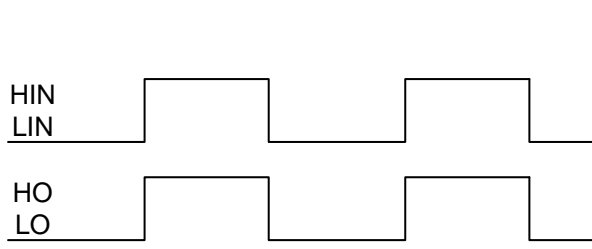

Figure 1. Input/Output Timing Diagram

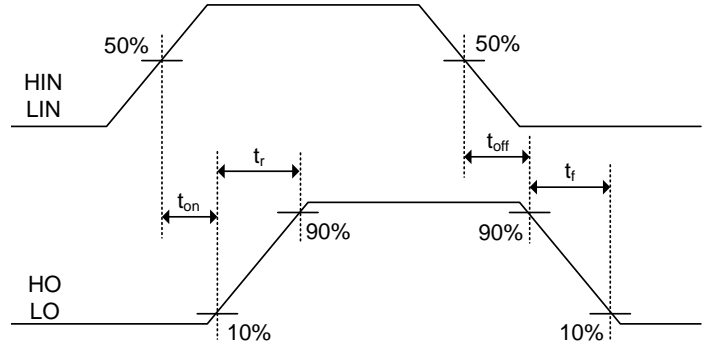

Figure 2. Switching Time Waveform Definitions

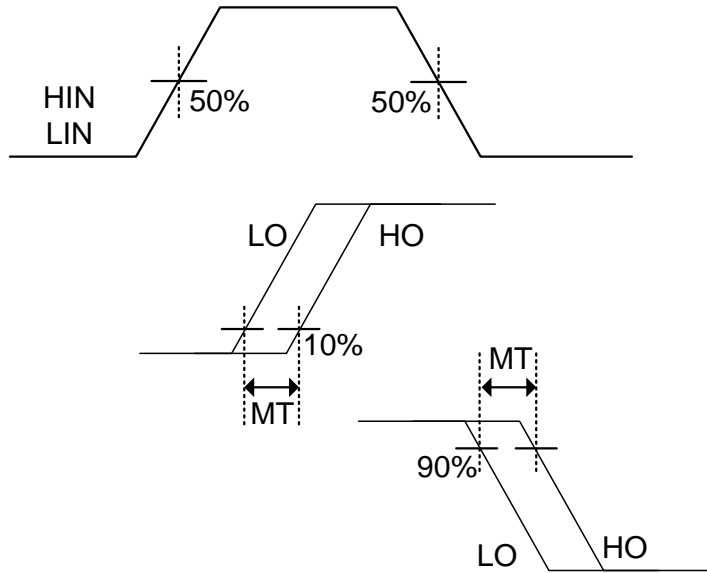

Figure 3. Delay Matching Waveform Definitions

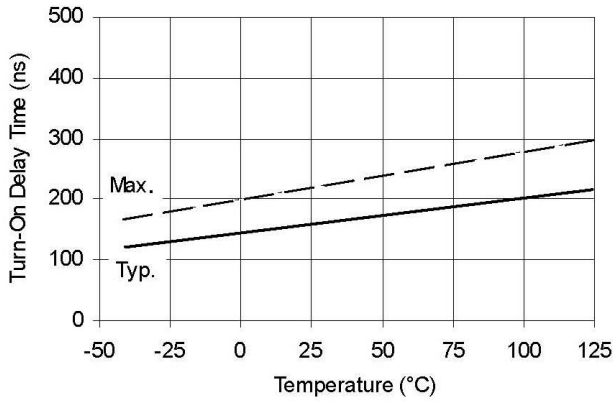

Figure 4A. Turn-On Delay Time vs. Temperature

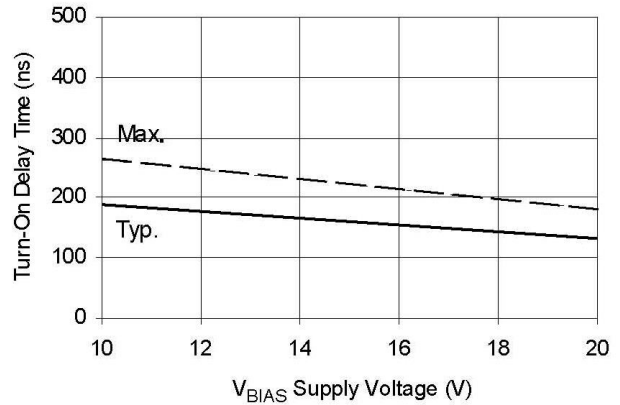

Figure 4B. Turn-On Delay Time vs. Supply Voltage

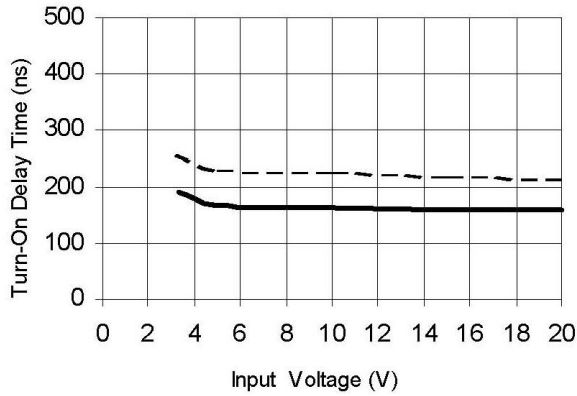

Figure 4C. Turn-On Delay Time vs. Input Voltage

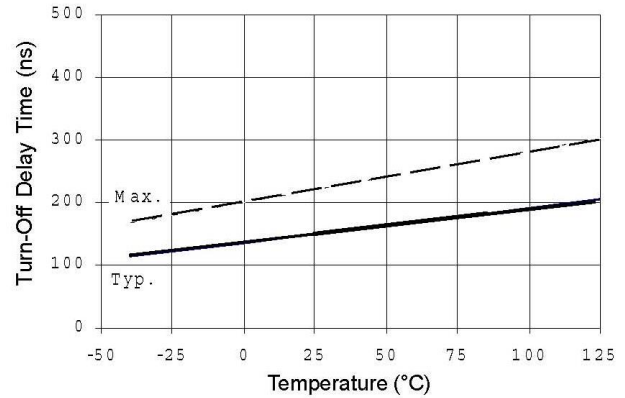

Figure 5A. Turn-Off Delay Time vs. Temperature

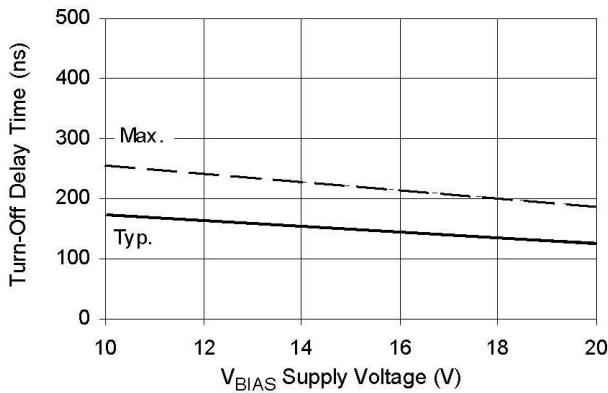

Figure 5B. Turn-Off Delay Time vs. Supply Voltage

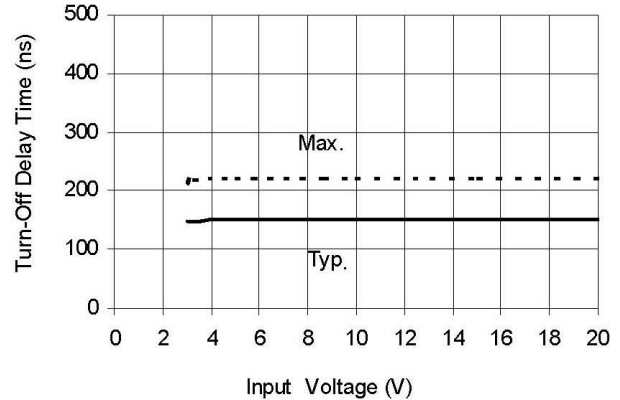

Figure 5C. Turn-Off Time vs. Input Voltage

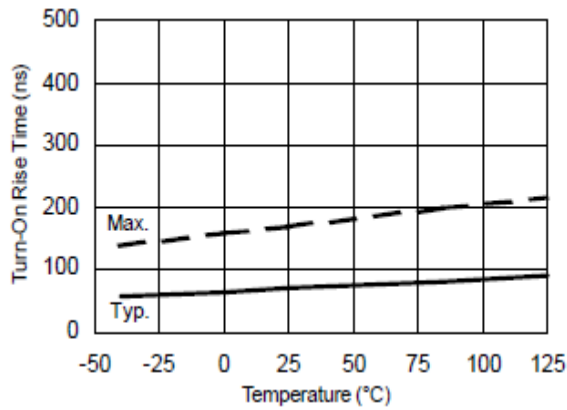

Figure 6A. Turn-On Rise Time vs. Temperature

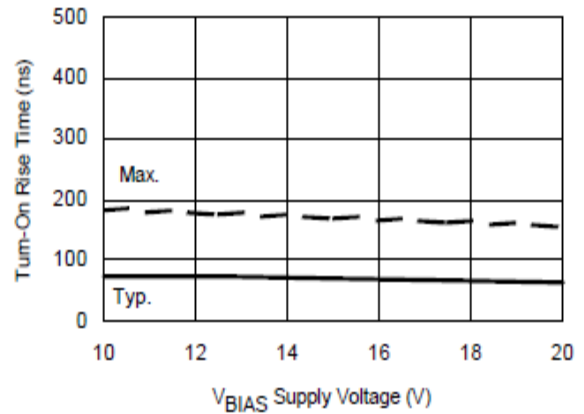

Figure 6B. Turn-On Rise Time vs. Voltage

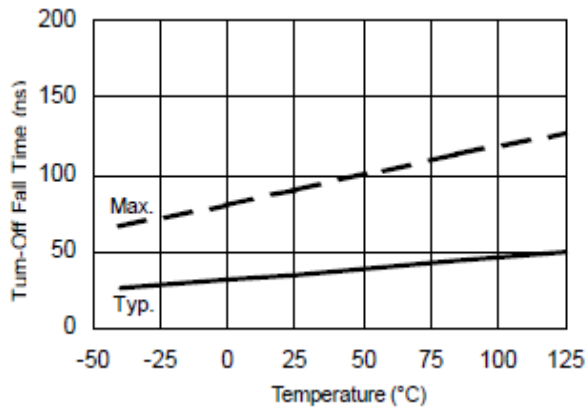

Figure 7A. Turn-Off Fall Time vs. Temperature

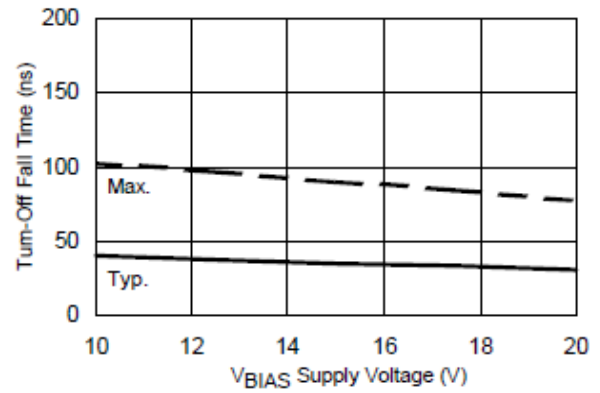

Figure 7B. Turn-Off Fall Time vs. Voltage

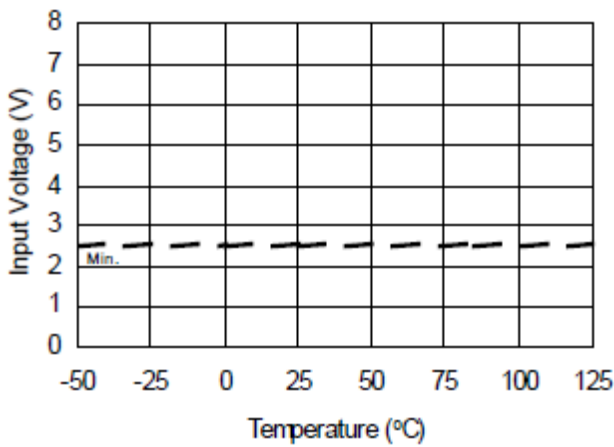

Figure 8A. Logic "1" Input Voltage vs. Temperature

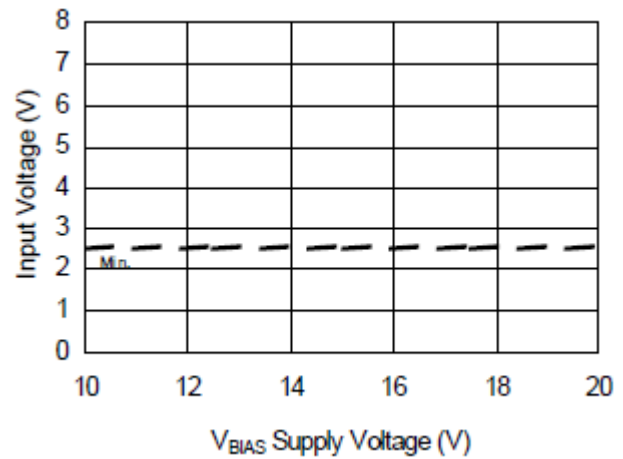

Figure 8B. Logic "1" Input Voltage vs. Voltage

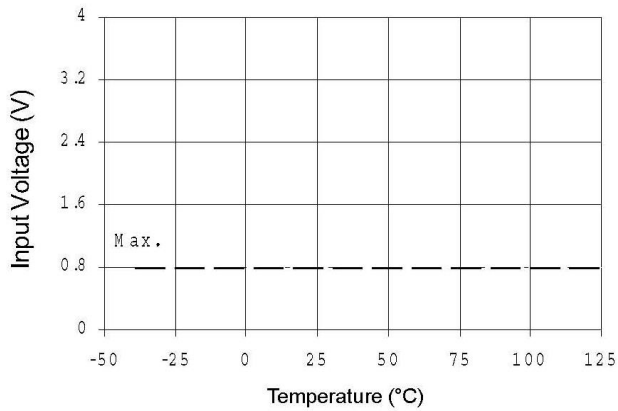

Figure 9A. Logic "0" Input Voltage vs. Temperature

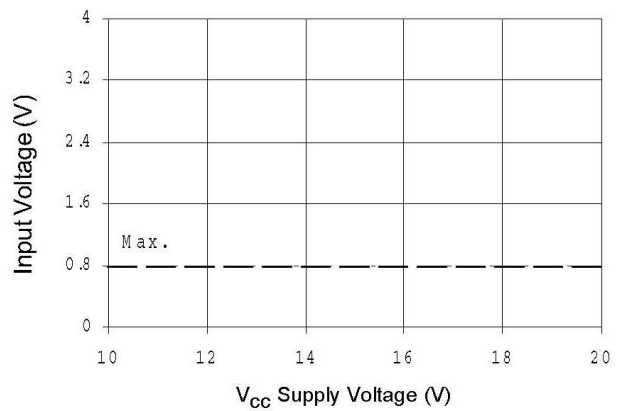

Figure 9B. Logic "0" Input Voltage vs. Supply Voltage

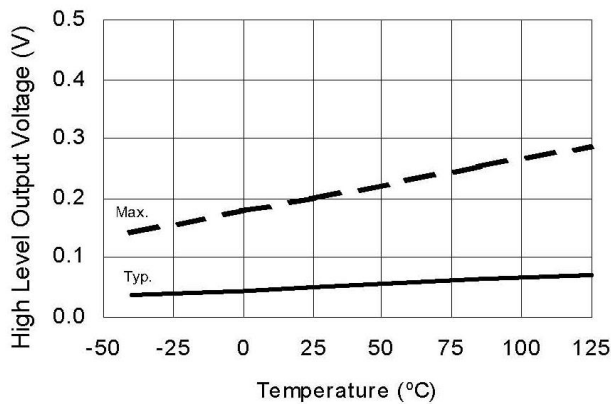

Figure 10A. High Level Output Voltage vs. Temperature

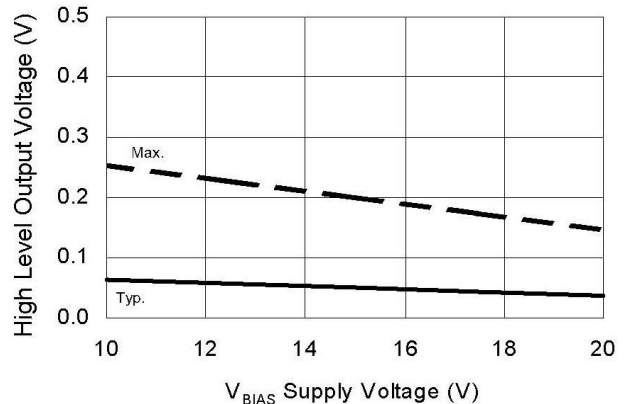

Figure 10B. High Level Output vs. Supply Voltage

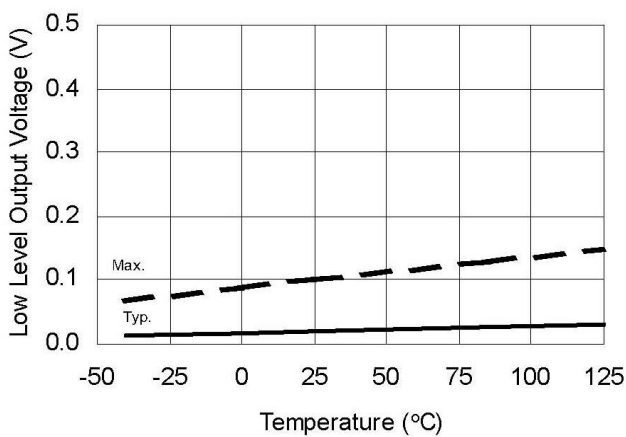

Figure 11A. Low Level Output Voltage vs. Temperature

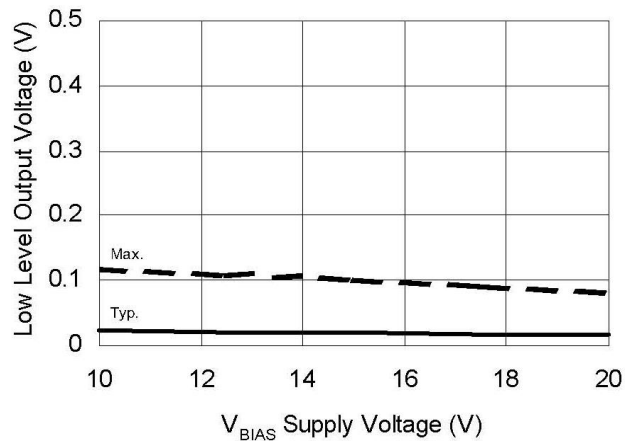

Figure 11B. Low Level Output vs. Supply Voltage

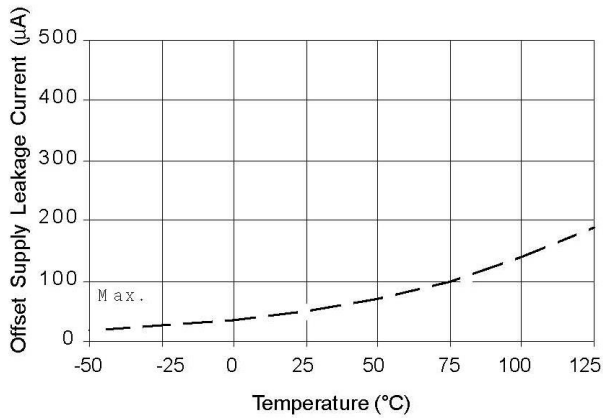

Figure 12A. Offset Supply Current vs. Temperature

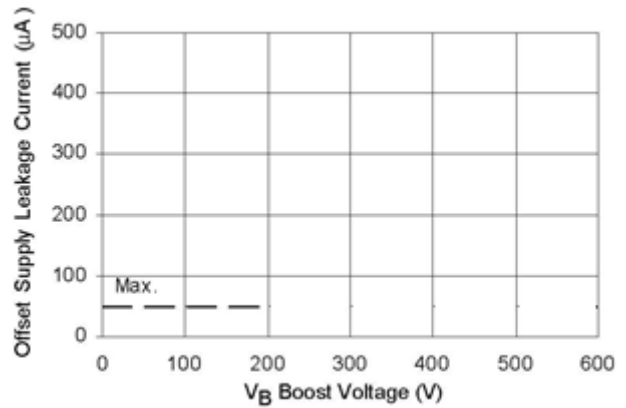

Figure 12B. Offset Supply Current vs. Voltage

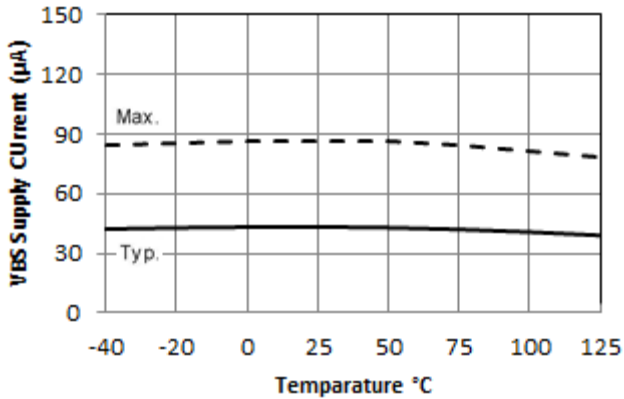

Figure 13A. V_{BS} Supply Current vs. Temperature

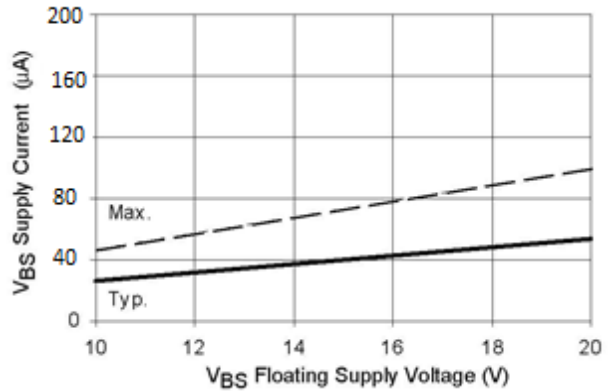

Figure 13B. V_{BS} Supply Current vs. Voltage

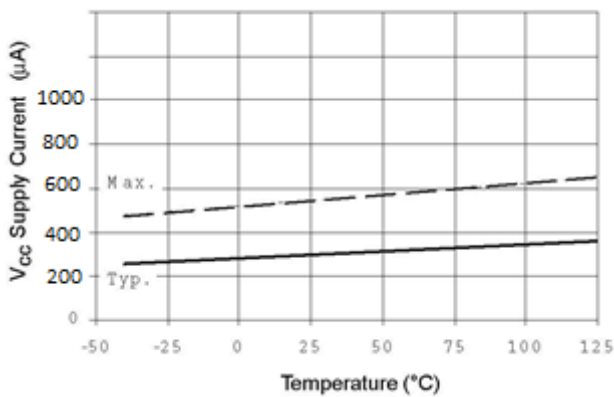

Figure 14A. V_{CC} Supply Current vs. Temperature

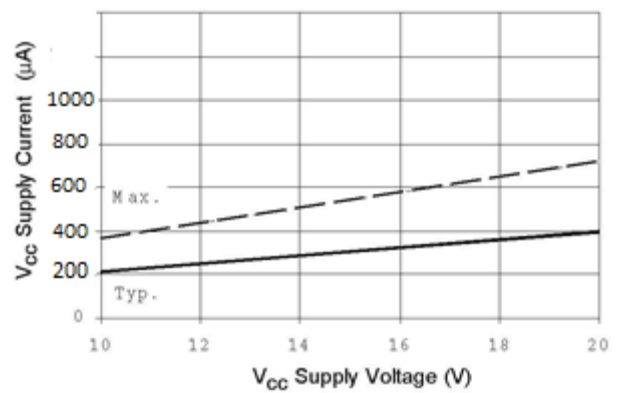

Figure 14B. V_{CC} Supply Current vs. Voltage

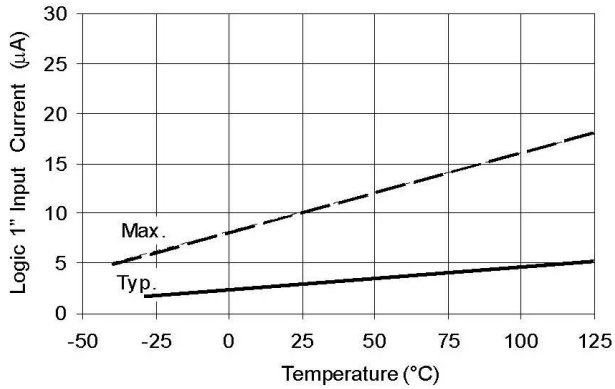

Figure 15A. Logic "1" Input Current vs. Temperature

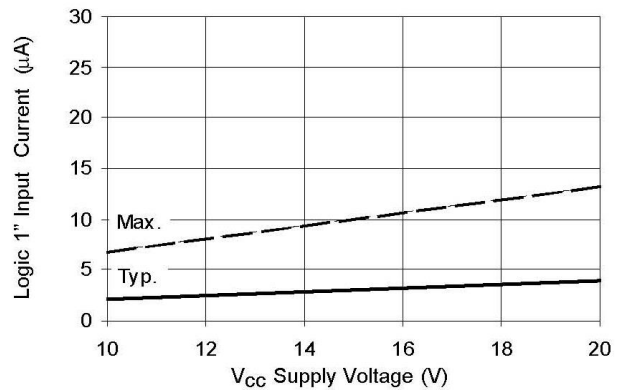

Figure 15B. Logic "1" Input Current vs. Voltage

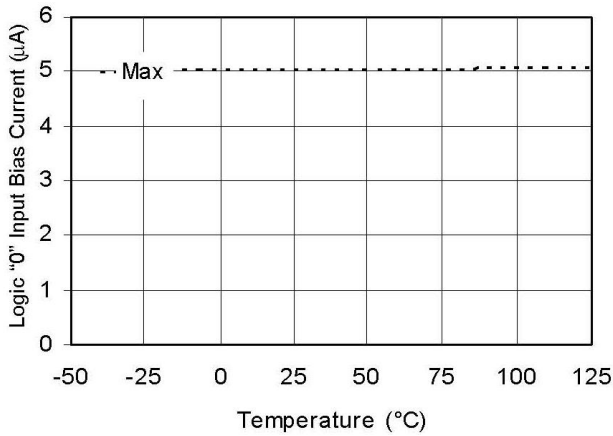

Figure 16A. Logic "0" Input Bias Current

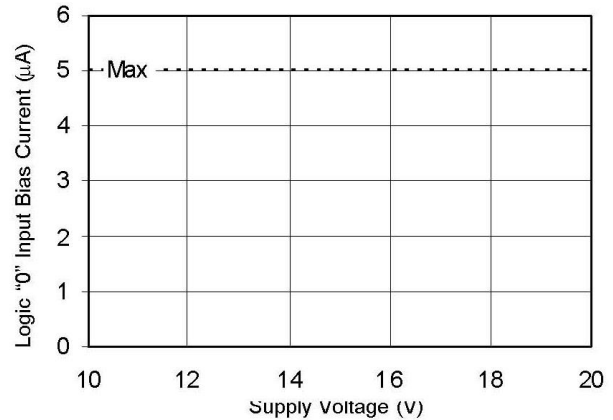

Figure 16B. Logic "0" Input Bias Current

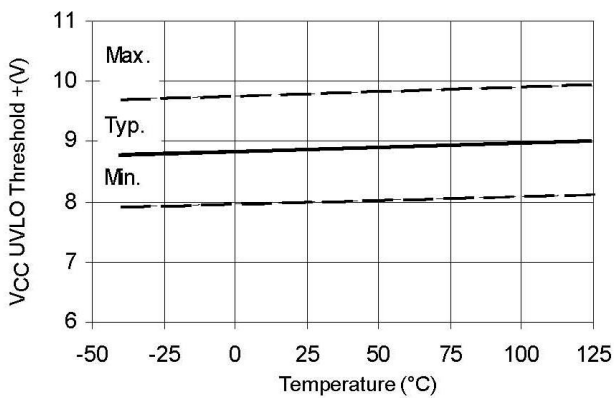

Figure 17A. V_{CC}/V_{BS} Undervoltage Threshold(+) vs. Temperature

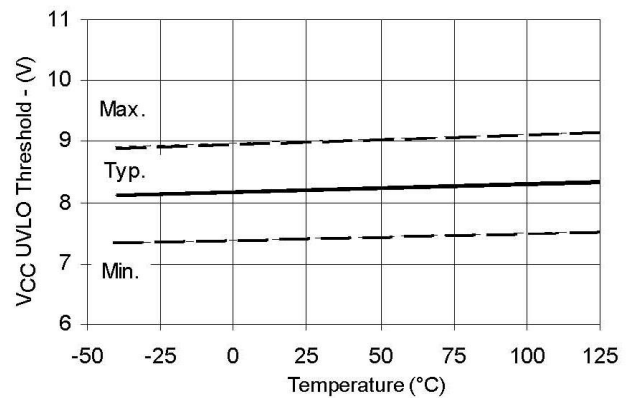

Figure 17B. V_{CC}/V_{BS} Undervoltage Threshold(-) vs. Temperature

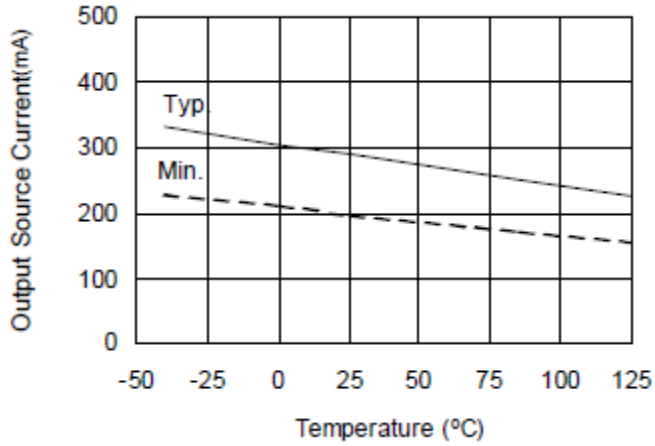

Figure 18A. Output Source Current vs. Temperature

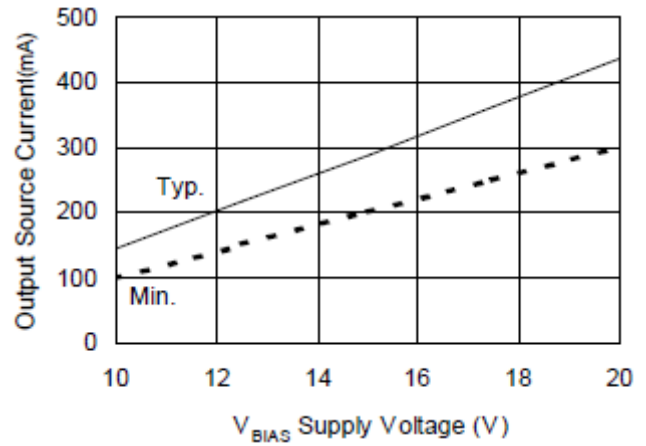

Figure 18B. Output Source Current vs. Supply Current

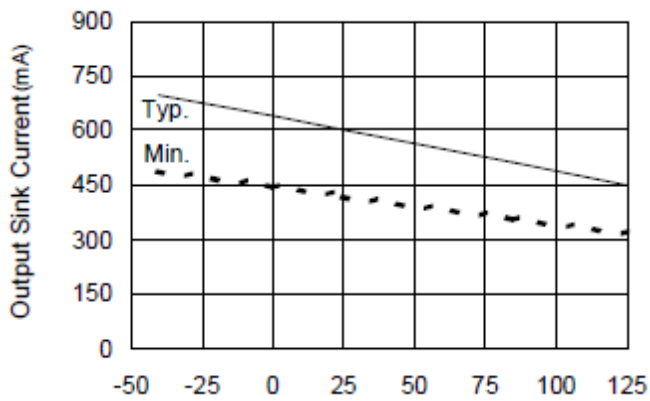

Figure 19A. Output Sink Current vs. Temperature

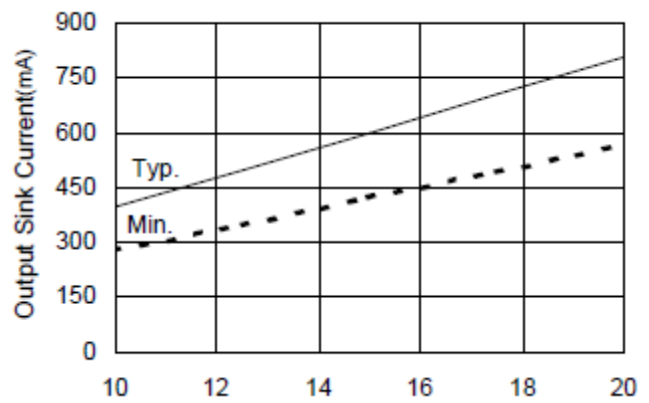
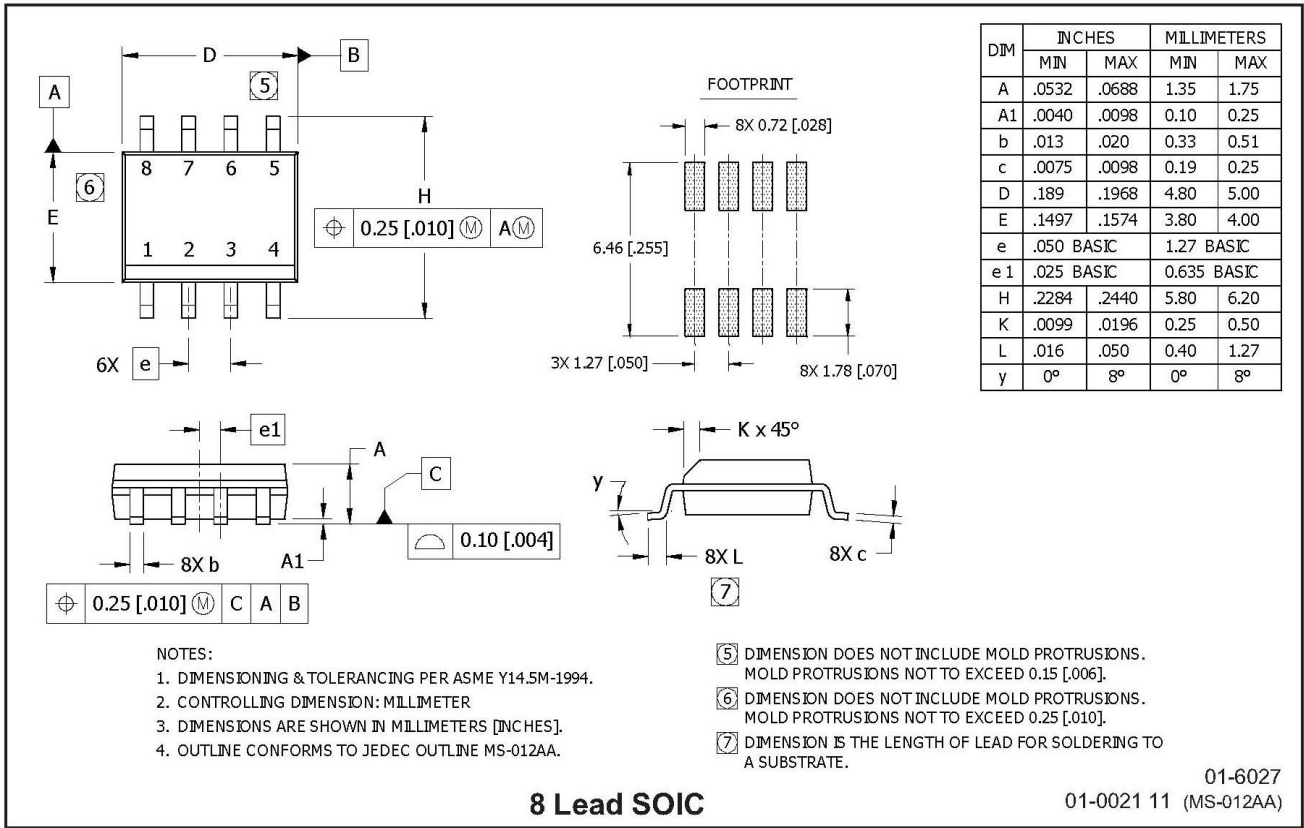
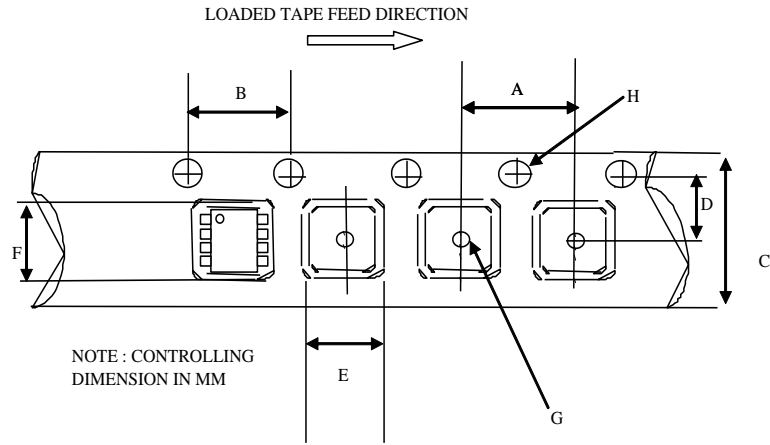

Figure 19B. Output Sink Current vs. Supply Voltage

Package Details: 8-Lead SOIC



Tape and Reel Details: 8-Lead SOIC



CARRIER TAPE DIMENSION FOR 8SOICN

Code	Metric		Imperial	
	Min	Max	Min	Max
A	7.90	8.10	0.311	0.318
B	3.90	4.10	0.153	0.161
C	11.70	12.30	0.46	0.484
D	5.45	5.55	0.214	0.218
E	6.30	6.50	0.248	0.255
F	5.10	5.30	0.200	0.208
G	1.50	n/a	0.059	n/a
H	1.50	1.60	0.059	0.062

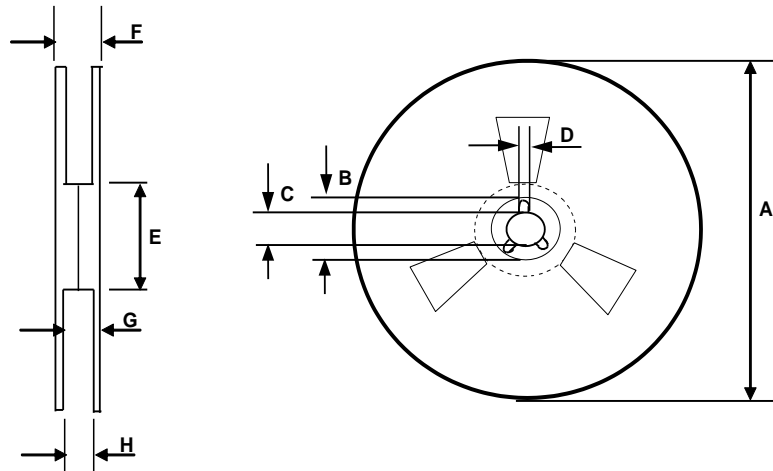

REEL DIMENSIONS FOR 8SOICN

Code	Metric		Imperial	
	Min	Max	Min	Max
A	329.60	330.25	12.976	13.001
B	20.95	21.45	0.824	0.844
C	12.80	13.20	0.503	0.519
D	1.95	2.45	0.767	0.096
E	98.00	102.00	3.858	4.015
F	n/a	18.40	n/a	0.724
G	14.50	17.10	0.570	0.673
H	12.40	14.40	0.488	0.566

Package Details: 14-Lead MLPQ 4x4

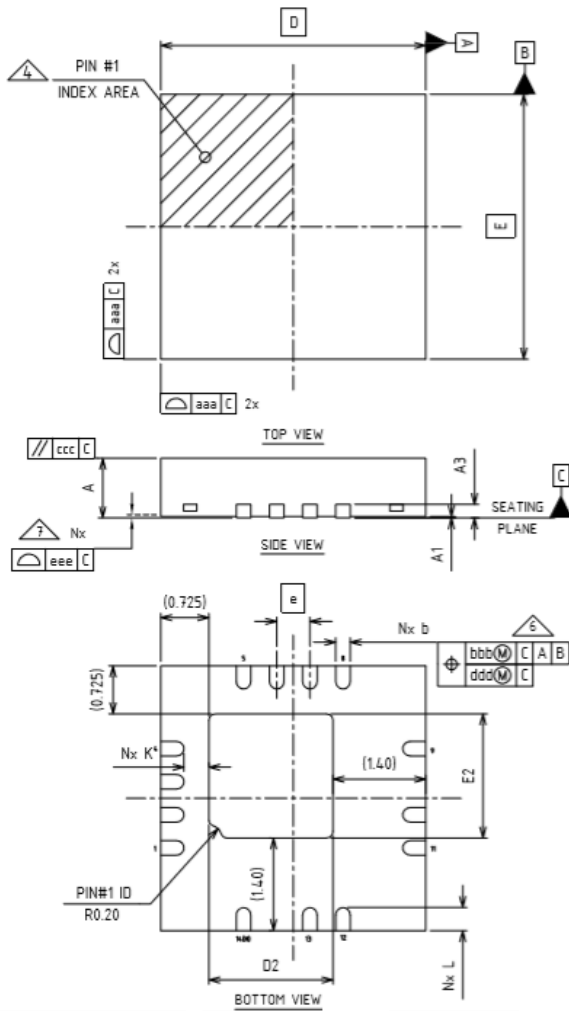

NOTE:

1. Dimensioning and tolerancing conform to ASME Y14.5-2009.
2. All dimensions are in millimeters.
3. N is the total number of terminals.
4. The location of the marked terminal #1 identifier is within the hatched area.
5. ND and NE refer to the number of terminals on each D and E side respectively.
6. Dimension b applies to the metallized terminal and is measured between 0.15mm and 0.30mm from the terminal tip. If the terminal has a radius on the other end of it, dimension b should not be measured in that radius area.
7. Coplanarity applies to the terminals and all other bottom surface metalization.

Dimension Table				NOTE
Thickness Symbol	V			
	MINIMUM	NOMINAL	MAXIMUM	
A	0.80	0.90	1.00	
A1	0.00	0.02	0.05	
A3	---	0.20 Ref	---	
b	0.18	0.25	0.30	6
D	4.00 BSC			
E	4.00 BSC			
e	0.50 BSC			
D2	1.725	1.875	1.975	
E2	1.725	1.875	1.975	
K	0.20	---	---	
L	0.25	0.35	0.45	
aaa	0.05			
bbb	0.10			
ccc	0.10			
ddd	0.05			
eee	0.08			
N	14			3
ND	SEE FIGURE			5
NE	SEE FIGURE			
NOTES	1, 2			

Tape and Reel Details: 14-Lead MLPQ 4x4

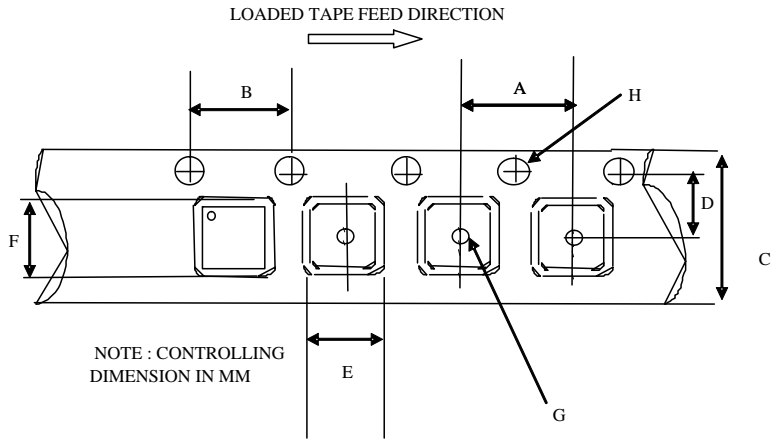

CARRIER TAPE DIMENSION FOR MLPQ4x4

Code	Metric		Imperial	
	Min	Max	Min	Max
A	7.90	8.10	0.311	0.358
B	3.90	4.10	0.153	0.161
C	11.70	12.30	0.461	0.484
D	5.45	5.55	0.215	0.219
E	4.25	4.45	0.168	0.176
F	4.25	4.45	0.168	0.176
G	1.50	n/a	0.069	n/a
H	1.50	1.60	0.069	0.063

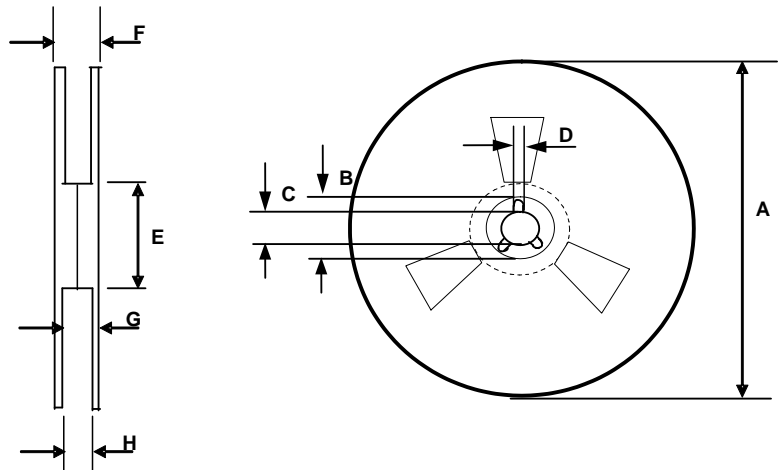

REEL DIMENSIONS FOR MLPQ4x4

Code	Metric		Imperial	
	Min	Max	Min	Max
A	329.60	330.25	12.976	13.001
B	20.95	21.45	0.824	0.844
C	12.80	13.20	0.503	0.519
D	1.95	2.45	0.767	0.096
E	98.00	102.00	3.858	4.015
F	n/a	18.40	n/a	0.724
G	14.50	17.10	0.570	0.673
H	12.40	14.40	0.488	0.566

Part Marking Information

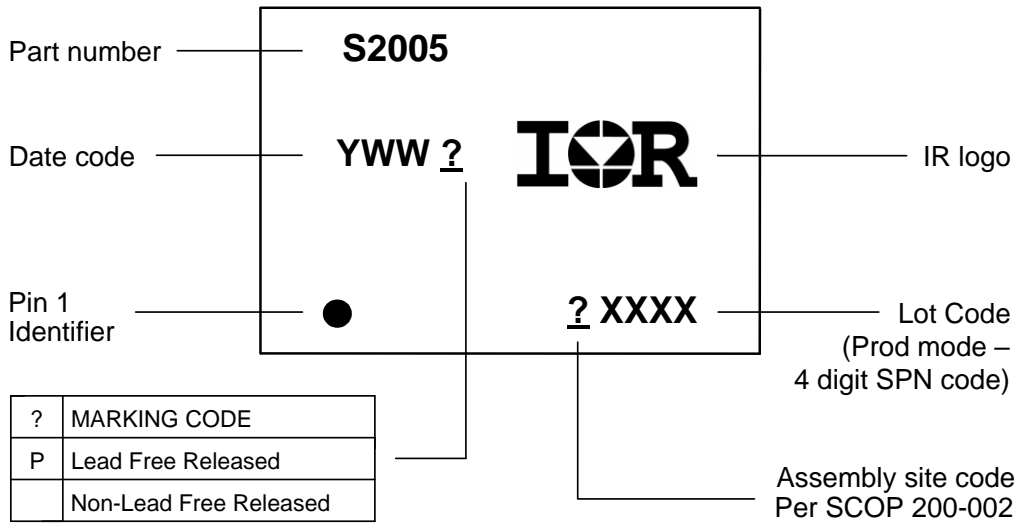

**8-Lead SOIC8
 IRS2005SPBF**

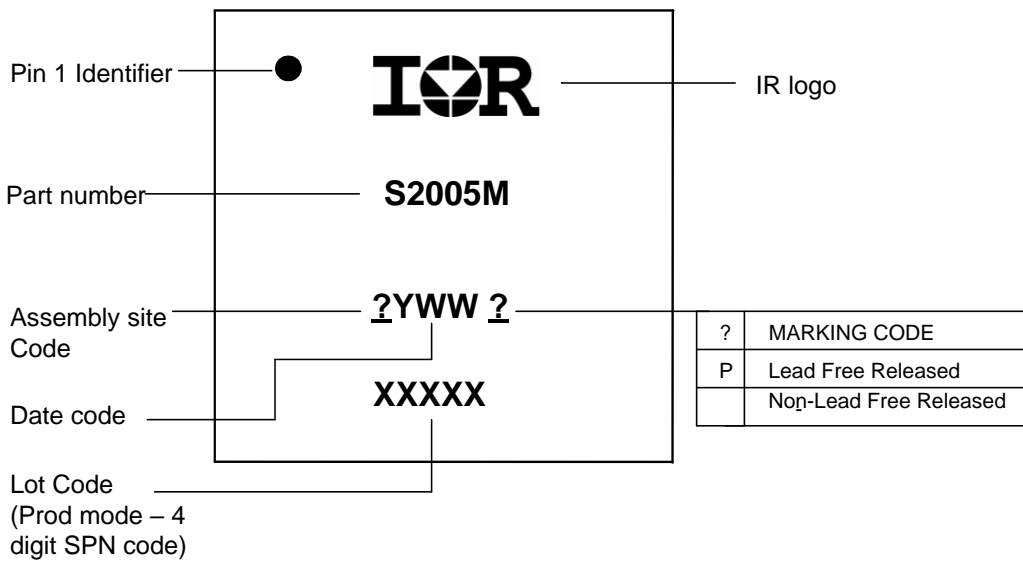

**14-Lead MLPQ 4x4
 IRS2005MPBF**

Qualification Information†

Qualification Level		Industrial††	
		Comments: This family of ICs has passed JEDEC's Industrial qualification. IR's Consumer qualification level is granted by extension of the higher Industrial level.	
Moisture Sensitivity Level		8 Lead SOIC	MSL2†††, 260°C (per IPC/JEDEC J-STD-020)
		14-Lead MLPQ 4x4	
ESD	Human Body Model	Class 2 (per JEDEC standard JESD22-A114)	
	Machine Model	Class A (per EIA/JEDEC standard EIA/JESD22-A115)	
IC Latch-Up Test		Class I (per JESD78)	
RoHS Compliant		Yes	

- † Qualification standards can be found at International Rectifier's web site <http://www.irf.com/>
- †† Higher qualification ratings may be available should the user have such requirements. Please contact your International Rectifier sales representative for further information.
- ††† Higher MSL ratings may be available for the specific package types listed here. Please contact your International Rectifier sales representative for further information.