

INTERNATIONAL RECTIFIER



AVALANCHE ENERGY RATED AND dv/dt RATED

HEXFET® TRANSISTOR

IRFV064

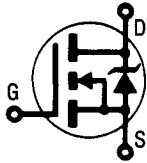

N-CHANNEL

60 Volt, 0.017 Ohm HEXFET

The HEXFET® technology is the key to International Rectifier's advanced line of power MOSFET transistors. The efficient geometry design achieves very low on-state resistance combined with high transconductance.

The HEXFET transistors also feature all of the well established advantages of MOSFETs such as voltage control, very fast switching, ease of paralleling and temperature stability of the electrical parameters.

They are well suited for applications such as switching power supplies and virtually any application where military and/or high reliability is required.

Product Summary

| Part Number | BV <sub>DSS</sub> | R <sub>DS(on)</sub> | I <sub>D</sub> |
|-------------|-------------------|---------------------|----------------|
| IRFV064     | 60V               | 0.017Ω              | 45A*           |

FEATURES:

- Avalanche Energy Rating
- Isolated and Hermetically Sealed
- Alternative to TO-3 Package
- Simple Drive Requirements
- Ease of Paralleling
- Ceramic Eyelets

CASE STYLE AND DIMENSIONS

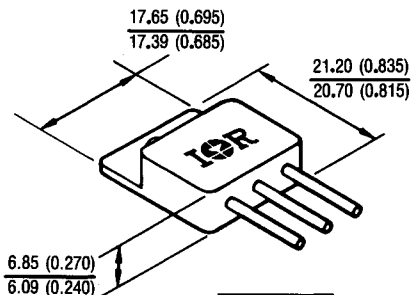

CAUTION

BERYLLIA WARNING PER MIL-S-19500  
SEE PAGE I-454

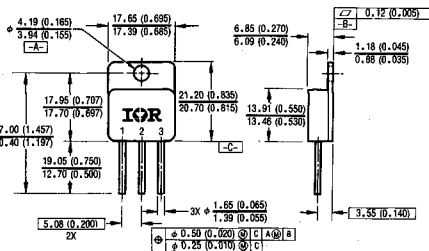

NOTES:  
 1 DIMENSIONING & TOLERANCING PER ANSI Y14.5M - 1982.  
 2 ALL DIMENSIONS ARE SHOWN IN MILLIMETERS (INCHES).  
 \*For optional leadforms see page I-454, fig. 15

LEGEND  
 1 DRAIN  
 2 SOURCE  
 3 GATE

Conforms to JEDEC Outline TO-258AA\*  
Dimensions in Millimeters and (Inches)

\*I<sub>D</sub> current limited by pin diameter

**Absolute Maximum Ratings**

| Parameter                                 | IRFV064                         | Units                                      |
|---|---------------------------------|--|
| $I_D$ @ $V_{GS} = 10V, T_C = 25^\circ C$  | Continuous Drain Current        | 45*  |
| $I_D$ @ $V_{GS} = 10V, T_C = 100^\circ C$ | Continuous Drain Current        | 45*  |
| $I_{DM}$                                  | Pulsed Drain Current ①          | 400  |
| $P_D$ @ $T_C = 25^\circ C$                | Max. Power Dissipation          | 300  |
|   | Linear Derating Factor          | 2.4  |
| $V_{GS}$                                  | Gate-to-Source Voltage          | $\pm 20$                                   |
| $E_{AS}$                                  | Single Pulse Avalanche Energy ② | 620  |
| $dv/dt$                                   | Peak Diode Recovery $dv/dt$ ③   | 4.5  |
| $T_J$                                     | Operating Junction              | -55 to 150                                 |
| $T_{STG}$                                 | Storage Temperature Range       |  |
|   | Lead Temperature                | 300 (0.063 in. (1.6 mm) from case for 10s) |
|   | Weight                          | 10.9 (typical)                             |

\* $I_D$  current limited by pin diameter

**Electrical Characteristics @  $T_J = 25^\circ C$  (Unless Otherwise Specified)**

| Parameter                    | Min.   | Typ. | Max.  | Units | Test Conditions |  |
|------------------------------|--|------|-------|-------|-----------------|--|
| $BV_{DSS}$                   | Drain-to-Source Breakdown Voltage            | 60   | —     | —     | V               | $V_{GS} = 0V, I_D = 1.0$ mA  |
| $\Delta BV_{DSS}/\Delta T_J$ | Temperature Coefficient of Breakdown Voltage | —    | 0.048 | —     | V/ $^\circ C$   | Reference to $25^\circ C, I_D = 1.0$ mA  |
| $R_{DS(on)}$                 | Static Drain-to-Source On-State Resistance   | —    | —     | 0.017 | $\Omega$        | $V_{GS} = 10V, I_D = 45A$ ④  |
| $V_{GS(th)}$                 | Gate Threshold Voltage                       | 2.0  | —     | 4.0   | V               | $V_{DS} = V_{GS}, I_D = 250$ $\mu A$   |
| $g_{fs}$                     | Forward Transconductance                     | 21   | —     | —     | S (V)           | $V_{DS} \geq 15V, I_{DS} = 45A$ ④  |
| $I_{DSS}$                    | Zero Gate Voltage Drain Current              | —    | —     | 25    | $\mu A$         | $V_{DS} = 0.8 \times$ Max. Rating, $V_{GS} = 0V$                                   |
|                              |  | —    | —     | 250   | $\mu A$         | $V_{DS} = 0.8 \times$ Max. Rating<br>$V_{GS} = 0V, T_J = 125^\circ C$              |
| $I_{GSS}$                    | Gate-to-Source Leakage Forward               | —    | —     | 100   | nA              | $V_{GS} = 20V$   |
| $I_{GSS}$                    | Gate-to-Source Leakage Reverse               | —    | —     | -100  | nA              | $V_{GS} = -20V$  |
| $Q_g$                        | Total Gate Charge                            | —    | —     | 240   | nC              | $V_{GS} = 10V, I_D = 45A$  |
| $Q_{gs}$                     | Gate-to-Source Charge                        | —    | —     | 53    | nC              | $V_{DS} = 0.5 \times$ Max. Rating  |
| $Q_{gd}$                     | Gate-to-Drain ("Miller") Charge              | —    | —     | 78    | nC              | See Fig. 6 and 14  |
| $t_d(on)$                    | Turn-On Delay Time                           | —    | —     | 27    | ns              | $V_{DD} = 30V, I_D = 45A, R_G = 2.35\Omega$  |
| $t_r$                        | Rise Time                                    | —    | —     | 120   | ns              |  |
| $t_d(off)$                   | Turn-Off Delay Time                          | —    | —     | 76    | ns              | See Fig. 11  |
| $t_f$                        | Fall Time                                    | —    | —     | 93    | ns              |  |
| $L_D$                        | Internal Drain Inductance                    | —    | 5.0   | —     | nH              | Measured from the drain lead, 6 mm (0.25 in.) from package to center of die.       |
| $L_S$                        | Internal Source Inductance                   | —    | 13    | —     | nH              | Measured from the source lead, 6 mm (0.25 in.) from package to source bonding pad. |
| $C_{iss}$                    | Input Capacitance                            | —    | 7400  | —     | pF              | $V_{GS} = 0V, V_{DS} = 25V$  |
| $C_{oss}$                    | Output Capacitance                           | —    | 3200  | —     | pF              | $f = 1.0$ MHz  |
| $C_{rss}$                    | Reverse Transfer Capacitance                 | —    | 540   | —     | pF              | See Fig. 5   |
| $C_{DC}$                     | Drain-to-Case Capacitance                    | —    | 12    | —     | pF              | $f = 1.0$ MHz  |

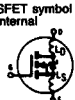

**Source-Drain Diode Ratings and Characteristics**

| Parameter                                     | Min.   | Typ. | Max. | Units         | Test Conditions   |
|---|--|------|------|---------------|---|
| $I_S$ Continuous Source Current (Body Diode)  | —  | —    | 45*  | A             | Modified MOSFET symbol showing the integral Reverse p-n junction rectifier.  |
| $I_{SM}$ Pulsed Source Current (Body Diode) ① | —  | —    | 400  |               |   |
| $V_{SD}$ Diode Forward Voltage                | —  | —    | 3.0  | V             | $T_J = 25^\circ\text{C}$ , $I_S = 45\text{A}$ , $V_{GS} = 0\text{V}$ ④  |
| $t_{rr}$ Reverse Recovery Time                | —  | —    | 220  | nS            | $T_J = 25^\circ\text{C}$ , $I_F = 45\text{A}$ , $dI/dt = \leq 100\text{A}/\mu\text{s}$ ④  |
| $Q_{RR}$ Reverse Recovery Charge              | —  | —    | 1.1  | $\mu\text{C}$ | $V_{DD} \leq 50\text{V}$  |
| $t_{on}$ Forward Turn-On Time                 | Intrinsic turn-on time is negligible. Turn-on speed is substantially controlled by $L_S + L_D$ . |      |      |               |   |

\* $I_S$  current limited by pin diameter

**Thermal Resistance**

| Parameter                      | Min. | Typ. | Max. | Units | Test Conditions  |
|--------------------------------|------|------|------|-------|--|
| $R_{thJC}$ Junction-to-Case    | —    | —    | 0.42 | K/W ⑤ | Mounting surface flat, smooth, and greased<br>Typical socket mount |
| $R_{thCS}$ Case-to-Sink        | —    | 0.21 | —    |       |  |
| $R_{thJA}$ Junction-to-Ambient | —    | —    | 30   |       |  |

① Repetitive Rating; Pulse width limited by maximum junction temperature (see figure 9) Refer to current HEXFET reliability report

② @  $V_{DD} = 25\text{V}$ , Starting  $T_J = 25^\circ\text{C}$ ,  $L \geq 79\text{mH}$ ,  $R_G = 25\Omega$ , Peak  $I_L = 45\text{A}$

③  $I_{SD} \leq 130\text{A}$ ,  $dI/dt \leq 300\text{A}/\mu\text{s}$ ,  $V_{DD} \leq BV_{DSS}$ ,  $T_J \leq 125^\circ\text{C}$   
Suggested  $R_G = 2.35\Omega$

④ Pulse width  $\leq 300\mu\text{s}$ ; Duty Cycle  $\leq 2\%$

⑤  $K/W = ^\circ\text{C}/W$   
 $W/K = W/^\circ\text{C}$

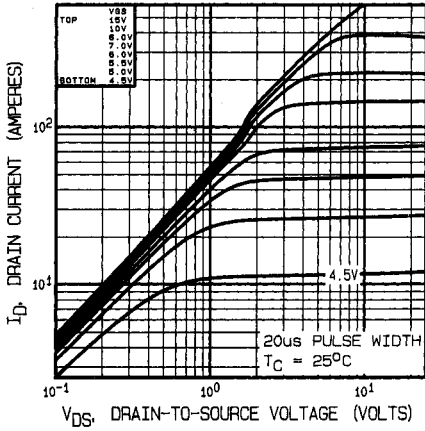

Fig. 1 — Typical Output Characteristics,  $T_C = 25^\circ C$

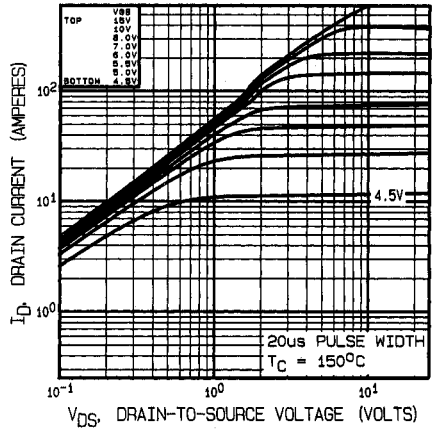

Fig. 2 — Typical Output Characteristics,  $T_C = 150^\circ C$

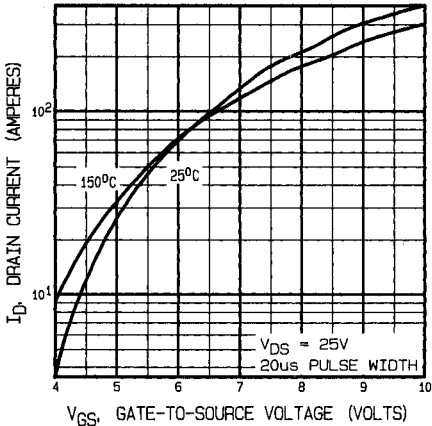

Fig. 3 — Typical Transfer Characteristics

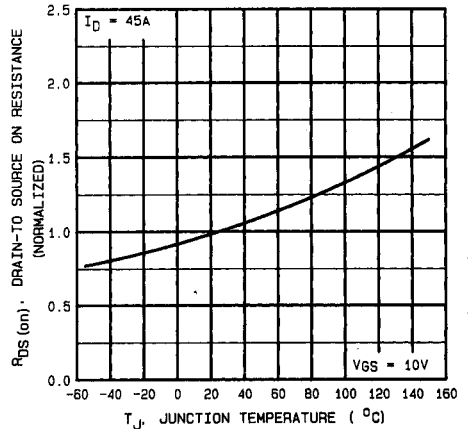

Fig. 4 — Normalized On-Resistance Vs. Temperature

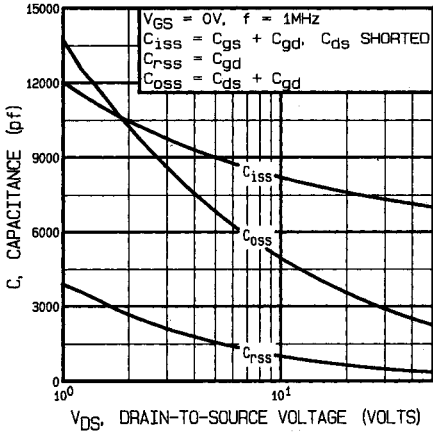

Fig. 5 — Typical Capacitance Vs. Drain-to-Source Voltage

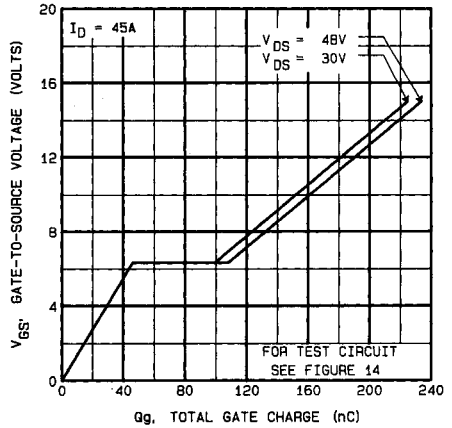

Fig. 6 — Typical Gate Charge Vs. Gate-to-Source Voltage

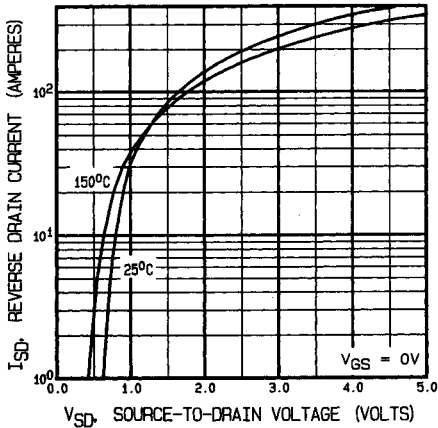

Fig. 7 — Typical Source-Drain Diode Forward Voltage

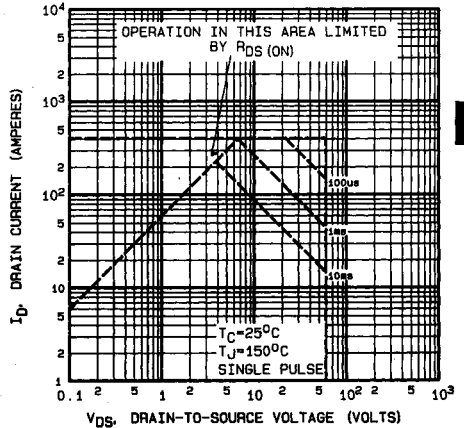

Fig. 8 — Maximum Safe Operating Area

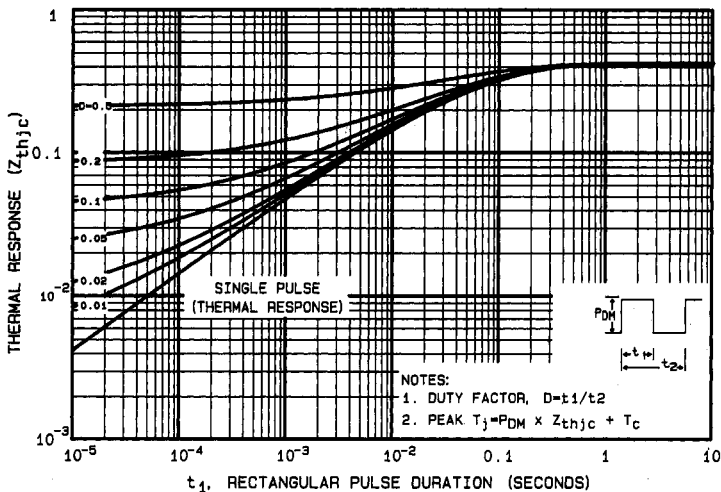

Fig. 9 — Maximum Effective Transient Thermal Impedance, Junction-to-Case Vs. Pulse Duration

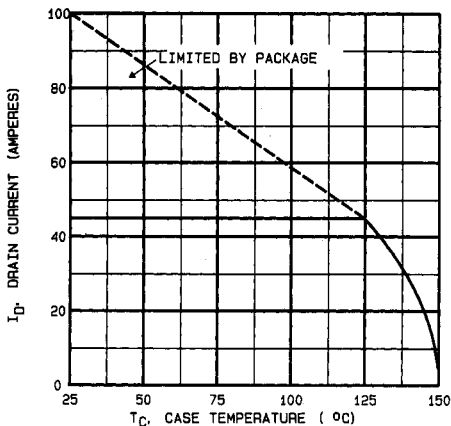

Fig. 10 — Maximum Drain Current Vs. Case Temperature

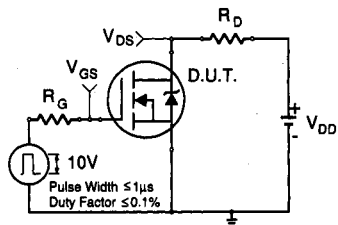

Fig. 11a — Switching Time Test Circuit

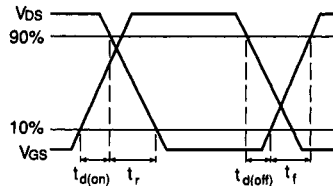

Fig. 11b — Switching Time Waveforms

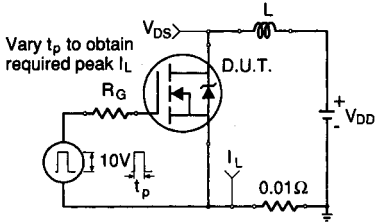

Fig. 12a — Unclamped Inductive Test Circuit

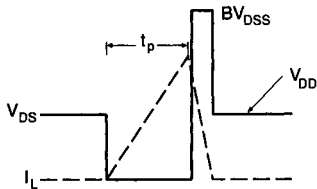

Fig. 12b — Unclamped Inductive Waveforms

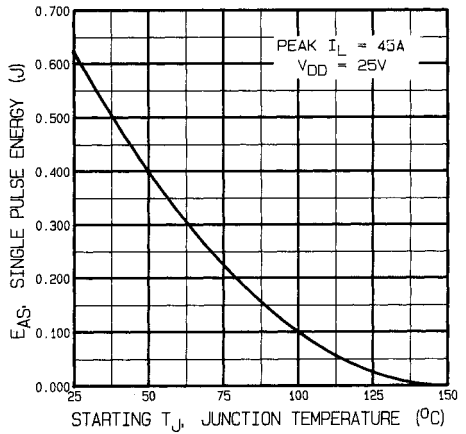
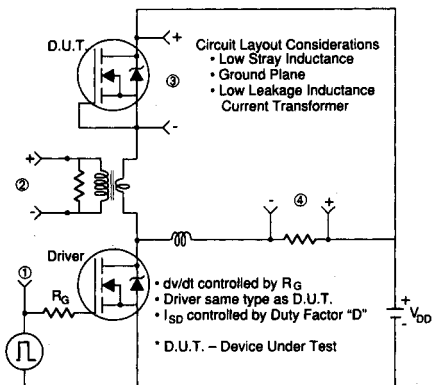

Fig. 12c — Maximum Avalanche Energy Vs. Starting Junction Temperature

 Fig. 13 — Peak Diode Recovery  $dv/dt$  Test Circuit

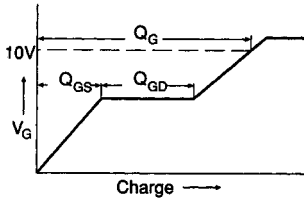

Fig. 14a — Basic Gate Charge Waveform

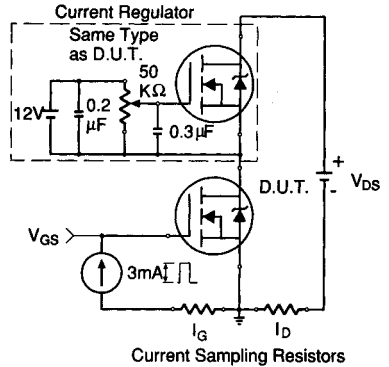

Fig. 14b — Gate Charge Test Circuit

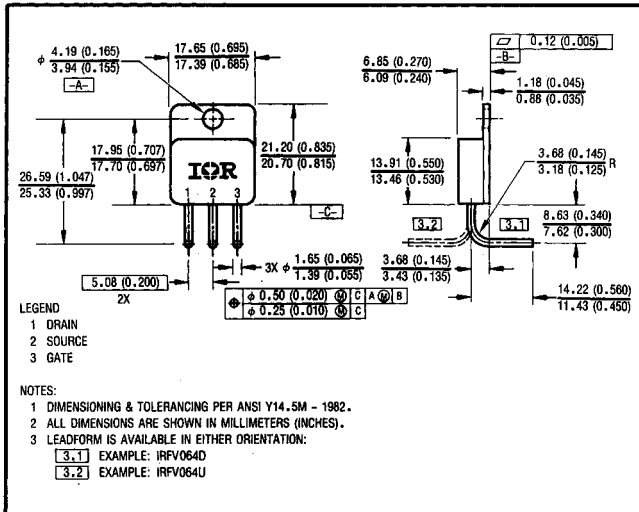

Fig. 15 — Optional Leadforms for Outline TO-258

**BERYLLIA WARNING PER MIL-S-19500**

Packages containing beryllia shall not be ground, sandblasted, machined, or have other operations performed on them which will produce beryllia or beryllium dust. Furthermore, beryllium oxide packages shall not be placed in acids that will produce fumes containing beryllium.