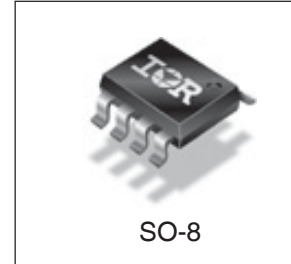
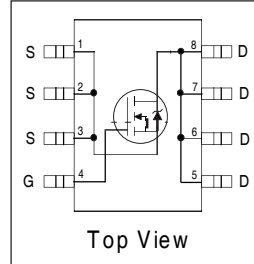


**HEXFET® Chip-Set for DC-DC Converters**

$V_{DS}$	<b>30</b>	<b>V</b>
$R_{DS(on) \text{ max}}$ (@ $V_{GS} = 4.5V$ )	<b>11</b>	<b>mΩ</b>
$Q_g$ (typical)	<b>22</b>	<b>nC</b>
$I_D$ (@ $T_A = 25^\circ C$ )	<b>13</b>	<b>A</b>



**Features**

Industry-standard pinout SO-8 Package
Compatible with Existing Surface Mount Techniques
RoHS Compliant, Halogen-Free
MSL1, Industrial qualification



**Benefits**

Multi-Vendor Compatibility
Easier Manufacturing
Environmentally Friendlier
Increased Reliability

Base Part Number	Package Type	Standard Pack		Orderable Part Number
		Form	Quantity	
IRF7805PbF-1	SO-8	Tape and Reel	4000	IRF7805TRPbF-1

**Absolute Maximum Ratings**

	Parameter	Max.	Units
$V_{DS}$	Drain-to-Source Voltage	30	V
$V_{GS}$	Gate-to-Source Voltage	± 12	
$I_D @ T_A = 25^\circ C$	Continuous Drain Current, $V_{GS} @ 10V$ ③	13	A
$I_D @ T_A = 70^\circ C$	Continuous Drain Current, $V_{GS} @ 10V$ ③	10	
$I_{DM}$	Pulsed Drain Current ①	100	
$P_D @ T_A = 25^\circ C$	Power Dissipation ③	2.5	W
$P_D @ T_A = 70^\circ C$	Power Dissipation ③	1.6	
	Linear Derating Factor	0.02	W/°C
$T_J$ $T_{STG}$	Operating Junction and Storage Temperature Range	-55 to + 150	°C

**Thermal Resistance**

	Parameter	Typ.	Max.	Units
$R_{\theta JL}$	Junction-to-Drain Lead ⑤	—	20	°C/W
$R_{\theta JA}$	Junction-to-Ambient ③⑤	—	50	

**Static @ T<sub>J</sub> = 25°C (unless otherwise specified)**

	Parameter	Min.	Typ.	Max.	Units	Conditions
BV <sub>DSS</sub>	Drain-to-Source Breakdown Voltage <sup>⑥</sup>	30	—	—	V	V <sub>GS</sub> = 0V, I <sub>D</sub> = 250μA
R <sub>DS(on)</sub>	Static Drain-to-Source On-Resistance <sup>⑥</sup>	—	9.2	11	mΩ	V <sub>GS</sub> = 4.5V, I <sub>D</sub> = 7.0A <sup>②</sup>
V <sub>GS(th)</sub>	Gate Threshold Voltage <sup>⑥</sup>	1.0	—	3.0	V	V <sub>DS</sub> = V <sub>GS</sub> , I <sub>D</sub> = 250μA
I <sub>DSS</sub>	Drain-to-Source Leakage Current	—	—	70	μA	V <sub>DS</sub> = 30V, V <sub>GS</sub> = 0V
		—	—	10		V <sub>DS</sub> = 24V, V <sub>GS</sub> = 0V
		—	—	150		V <sub>DS</sub> = 24V, V <sub>GS</sub> = 0V, T <sub>J</sub> = 100°C
I <sub>GSS</sub>	Gate-to-Source Forward Leakage	—	—	100	nA	V <sub>GS</sub> = 12V
	Gate-to-Source Reverse Leakage	—	—	-100		V <sub>GS</sub> = -12V
Q <sub>g</sub>	Total Gate Charge <sup>⑥</sup>	—	22	31	nC	V <sub>GS</sub> = 5.0V
Q <sub>gs1</sub>	Pre-V <sub>th</sub> Gate-to-Source Charge	—	3.7	—		V <sub>DS</sub> = 16V
Q <sub>gs2</sub>	Post-V <sub>th</sub> Gate-to-Source Charge	—	1.4	—		I <sub>D</sub> = 7.0A
Q <sub>gd</sub>	Gate-to-Drain Charge	—	6.8	—		
Q <sub>sw</sub>	Switch Charge (Q <sub>gs2</sub> + Q <sub>gd</sub> ) <sup>⑥</sup>	—	8.2	11.5		
Q <sub>oss</sub>	Output Charge <sup>⑥</sup>	—	3.0	3.6	nC	V <sub>DS</sub> = 16V, V <sub>GS</sub> = 0V
R <sub>G</sub>	Gate Resistance	0.5	—	1.7	Ω	
t <sub>d(on)</sub>	Turn-On Delay Time	—	16	—	ns	V <sub>DD</sub> = 16V, V <sub>GS</sub> = 4.5V <sup>③</sup>
t <sub>r</sub>	Rise Time	—	20	—		I <sub>D</sub> = 7.0A
t <sub>d(off)</sub>	Turn-Off Delay Time	—	38	—		R <sub>G</sub> = 2Ω
t <sub>f</sub>	Fall Time	—	16	—		Resistive Load

**Diode Characteristics**

	Parameter	Min.	Typ.	Max.	Units	Conditions
I <sub>S</sub>	Continuous Source Current (Body Diode) <sup>①</sup>	—	—	2.5	A	MOSFET symbol showing the integral reverse p-n junction diode.
I <sub>SM</sub>	Pulsed Source Current (Body Diode)	—	—	106		
V <sub>SD</sub>	Diode Forward Voltage <sup>⑥</sup>	—	—	1.2	V	T <sub>J</sub> = 25°C, I <sub>S</sub> = 7.0A, V <sub>GS</sub> = 0V
Q <sub>rr</sub>	Reverse Recovery Charge <sup>④</sup>	—	88	—	nC	di/dt = 700A/μs V <sub>DS</sub> = 16V, V <sub>GS</sub> = 0V, I <sub>S</sub> = 7.0A
Q <sub>rr(s)</sub>	Reverse Recovery Charge (with Parallel Schottky) <sup>④</sup>	—	55	—	nC	di/dt = 700A/μs (with 10BQ040) V <sub>DS</sub> = 16V, V <sub>GS</sub> = 0V, I <sub>S</sub> = 7.0A

**Notes:**

- ① Repetitive rating; pulse width limited by max. junction temperature.
- ② Pulse width ≤ 300 μs; duty cycle ≤ 2%.
- ③ When mounted on 1 inch square copper board, t < 10 sec.
- ④ Typ = measured - Q<sub>oss</sub>
- ⑤ R<sub>G</sub> is measured at T<sub>J</sub> of approximately 90°C.
- ⑥ Devices are 100% tested to these parameters.

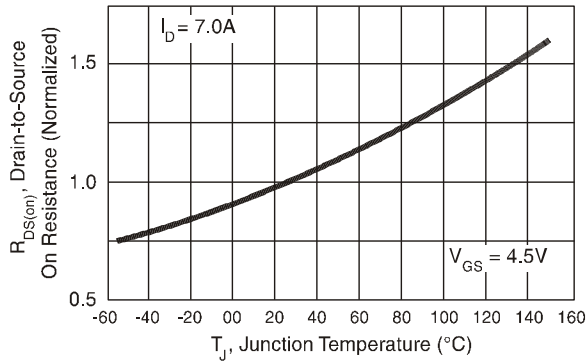
**Typical Characteristics**


Fig 1. Normalized On-Resistance vs. Temperature

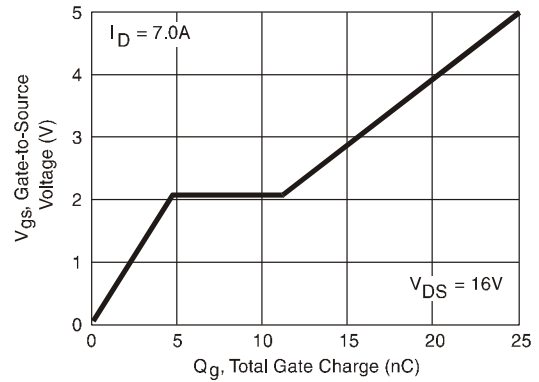


Fig 2. Typical Gate Charge vs. Gate-to-Source Voltage

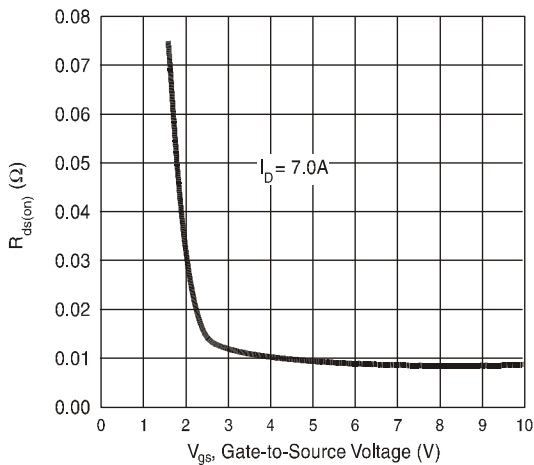
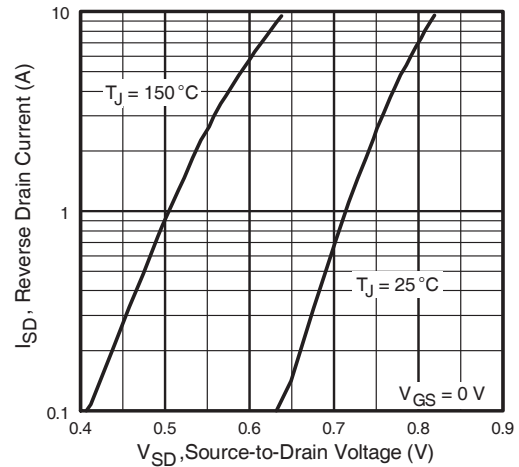

 Fig 3. Typical  $R_{DS(on)}$  vs. Gate-to-Source Voltage


Fig 4. Typical Source-Drain Diode Forward Voltage

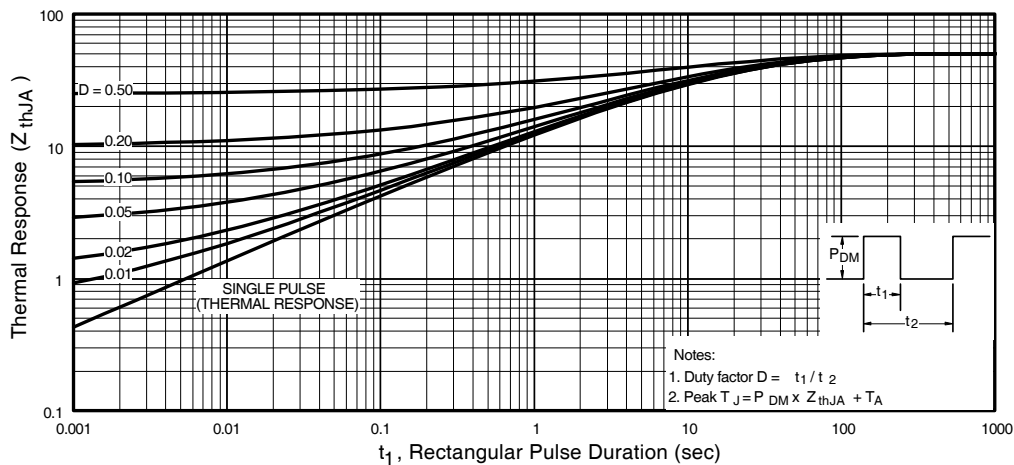
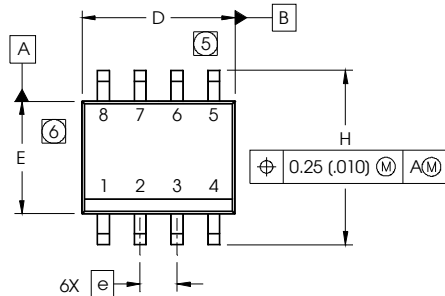
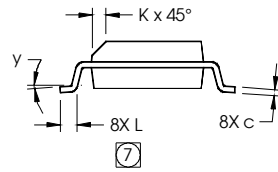
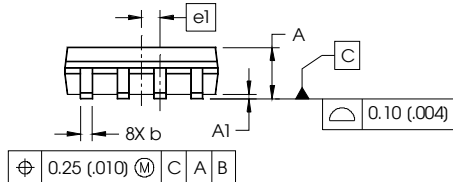


Figure 5. Maximum Effective Transient Thermal Impedance, Junction-to-Ambient

### SO-8 Package Details



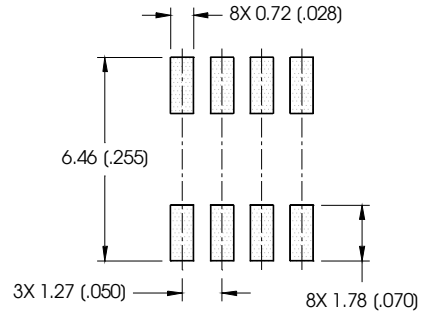
DIM	INCHES		MILLIMETERS	
	MIN	MAX	MIN	MAX
A	.0532	.0688	1.35	1.75
A1	.0040	.0098	0.10	0.25
b	.013	.020	0.33	0.51
c	.0075	.0098	0.19	0.25
D	.189	.1968	4.80	5.00
E	.1497	.1574	3.80	4.00
e	.050 BASIC		1.27 BASIC	
e1	.025 BASIC		0.635 BASIC	
H	.2284	.2440	5.80	6.20
K	.0099	.0196	0.25	0.50
L	.016	.050	0.40	1.27
y	0°	8°	0°	8°



**NOTES:**

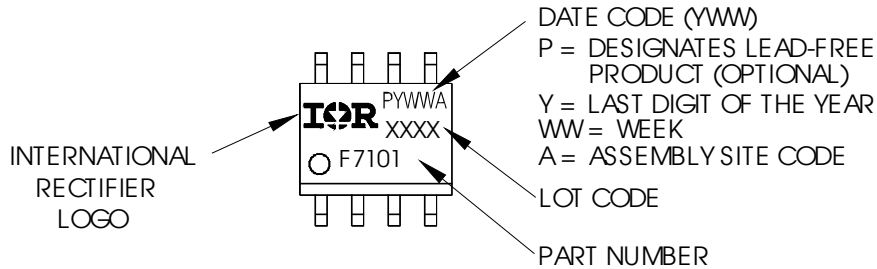
1. DIMENSIONING & TOLERANCING PER ASME Y14.5M-1994.
2. CONTROLLING DIMENSION: MILLIMETER
3. DIMENSIONS ARE SHOWN IN MILLIMETERS (INCHES).
4. OUTLINE CONFORMS TO JEDEC OUTLINE MS-012AA.
5. DIMENSION DOES NOT INCLUDE MOLD PROTRUSIONS. MOLD PROTRUSIONS NOT TO EXCEED 0.15 (.006).
6. DIMENSION DOES NOT INCLUDE MOLD PROTRUSIONS. MOLD PROTRUSIONS NOT TO EXCEED 0.25 (.010).
7. DIMENSION IS THE LENGTH OF LEAD FOR SOLDERING TO A SUBSTRATE.

**FOOTPRINT**

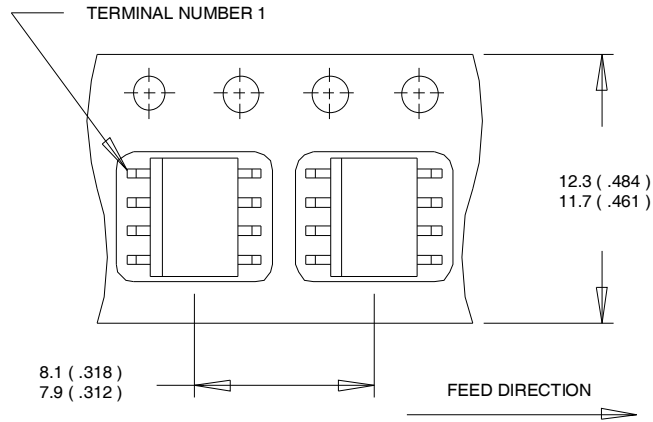


### SO-8 Part Marking

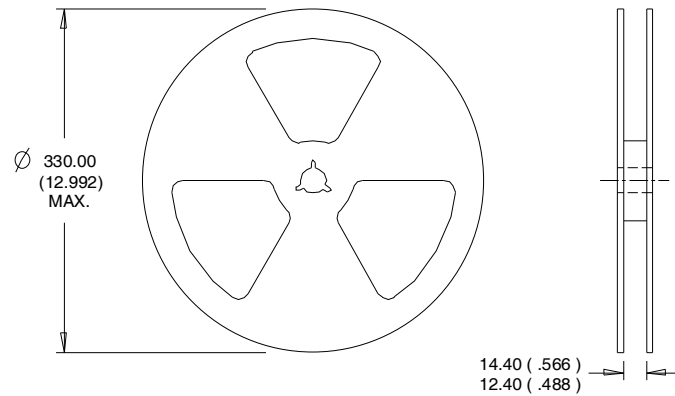
EXAMPLE: THIS IS AN IRF7101 (MOSFET)



Note: For the most current drawing please refer to IR website at <http://www.irf.com/package/>

**SO-8 Tape and Reel**


- NOTES:
1. CONTROLLING DIMENSION : MILLIMETER.
  2. ALL DIMENSIONS ARE SHOWN IN MILLIMETERS(INCHES).
  3. OUTLINE CONFORMS TO EIA-481 & EIA-541.



- NOTES:
1. CONTROLLING DIMENSION : MILLIMETER.
  2. OUTLINE CONFORMS TO EIA-481 & EIA-541.

Note: For the most current drawing please refer to IR website at <http://www.irf.com/package/>

**Qualification information<sup>†</sup>**

Qualification level	Industrial (per JEDEC JESD47F <sup>††</sup> guidelines)	
Moisture Sensitivity Level	SO-8	MSL1 (per JEDEC J-STD-020D <sup>††</sup> )
RoHS compliant	Yes	

<sup>†</sup> Qualification standards can be found at International Rectifier's web site: <http://www.irf.com/product-info/reliability>

<sup>††</sup> Applicable version of JEDEC standard at the time of product release

**Revision History**

Date	Comments
10/16/2014	<ul style="list-style-type: none"> <li>Corrected part number from "IRF7805PbF-1" to "IRF7805TRPbF-1" -all pages</li> <li>Removed the "IRF7805PbF-1" bulk part number from ordering information on page1</li> </ul>

International  
 Rectifier

**IR WORLD HEADQUARTERS:** 101 N. Sepulveda Blvd., El Segundo, California 90245, USA

To contact International Rectifier, please visit <http://www.irf.com/whoto-call/>