

MOSFET

- Ultra Low On-Resistance
- Dual N-Channel MOSFET
- Surface Mount
- Fully Avalanche Rated

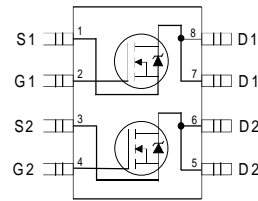

Top View

$$V_{DSS} = 20V$$

$$R_{DS(on)} = 0.029\Omega$$

Description

The SO-8 has been modified through a customized leadframe for enhanced thermal characteristics and multiple-die capability making it ideal in a variety of power applications. With these improvements, multiple devices can be used in an application with dramatically reduced board space. The package is designed for vapor phase, infra red, or wave soldering techniques.

SOP-8

Absolute Maximum Ratings ($T_A = 25^\circ C$ Unless Otherwise Noted)

		Symbol	Maximum	Units
Drain-Source Voltage		V_{DS}	20	V
Gate-Source Voltage		V_{GS}	± 12	
Continuous Drain Current ^⑤	$T_A = 25^\circ C$	I_D	6.6	A
	$T_A = 70^\circ C$		5.3	
Pulsed Drain Current		I_{DM}	26	
Continuous Source Current (Diode Conduction)		I_S	2.5	
Maximum Power Dissipation ^⑤	$T_A = 25^\circ C$	P_D	2.0	W
	$T_A = 70^\circ C$		1.3	
Single Pulse Avalanche Energy ^②		E_{AS}	100	mJ
Avalanche Current		I_{AR}	4.1	A
Repetitive Avalanche Energy		E_{AR}	0.20	mJ
Peak Diode Recovery dv/dt ^③		dv/dt	5.0	V/ ns
Junction and Storage Temperature Range		T_J, T_{STG}	-55 to + 150	$^\circ C$

Thermal Resistance Ratings

Parameter	Symbol	Limit	Units
Maximum Junction-to-Ambient ^⑤	$R_{\theta JA}$	62.5	$^\circ C/W$

Electrical Characteristics @ $T_J = 25^\circ\text{C}$ (unless otherwise specified)

	Parameter	Min.	Typ.	Max.	Units	Conditions
$V_{(BR)DSS}$	Drain-to-Source Breakdown Voltage	20	—	—	V	$V_{GS} = 0V, I_D = 250\mu A$
$\Delta V_{(BR)DSS}/\Delta T_J$	Breakdown Voltage Temp. Coefficient	—	0.027	—	V/ $^\circ\text{C}$	Reference to $25^\circ\text{C}, I_D = 1\text{mA}$
$R_{DS(on)}$	Static Drain-to-Source On-Resistance	—	0.023	0.029	Ω	$V_{GS} = 4.5V, I_D = 6.0A$ ④
		—	0.030	0.046		$V_{GS} = 2.7V, I_D = 5.2A$ ④
$V_{GS(th)}$	Gate Threshold Voltage	0.7	—	—	V	$V_{DS} = V_{GS}, I_D = 250\mu A$
g_{fs}	Forward Transconductance	—	20	—	S	$V_{DS} = 10V, I_D = 6.0A$
I_{DSS}	Drain-to-Source Leakage Current	—	—	1.0	μA	$V_{DS} = 16V, V_{GS} = 0V$
		—	—	5.0		$V_{DS} = 16V, V_{GS} = 0V, T_J = 55^\circ\text{C}$
I_{GSS}	Gate-to-Source Forward Leakage	—	—	100	nA	$V_{GS} = 12V$
	Gate-to-Source Reverse Leakage	—	—	-100		$V_{GS} = -12V$
Q_g	Total Gate Charge	—	18	27	nC	$I_D = 6.0A$
Q_{gs}	Gate-to-Source Charge	—	2.2	3.3		$V_{DS} = 10V$
Q_{gd}	Gate-to-Drain ("Miller") Charge	—	6.2	9.3		$V_{GS} = 4.5V$, See Fig. 10 ④
$t_{d(on)}$	Turn-On Delay Time	—	8.1	12	ns	$V_{DD} = 10V$
t_r	Rise Time	—	17	25		$I_D = 1.0A$
$t_{d(off)}$	Turn-Off Delay Time	—	38	57		$R_G = 6.0\Omega$
t_f	Fall Time	—	31	47		$R_D = 10\Omega$ ④
C_{iss}	Input Capacitance	—	900	—	pF	$V_{GS} = 0V$
C_{oss}	Output Capacitance	—	430	—		$V_{DS} = 15V$
C_{riss}	Reverse Transfer Capacitance	—	200	—		$f = 1.0\text{MHz}$, See Fig. 9

Source-Drain Ratings and Characteristics

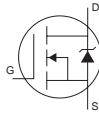
	Parameter	Min.	Typ.	Max.	Units	Conditions
I_S	Continuous Source Current (Body Diode)	—	—	2.5	A	MOSFET symbol showing the integral reverse p-n junction diode. 
I_{SM}	Pulsed Source Current (Body Diode) ①	—	—	26		
V_{SD}	Diode Forward Voltage	—	0.72	1.0	V	$T_J = 25^\circ\text{C}, I_S = 1.7A, V_{GS} = 0V$ ③
t_{rr}	Reverse Recovery Time	—	52	77	ns	$T_J = 25^\circ\text{C}, I_F = 1.7A$
Q_{rr}	Reverse Recovery Charge	—	58	86	nC	$di/dt = 100A/\mu s$ ③

Notes:

- ① Repetitive rating; pulse width limited by max. junction temperature. (See fig. 11)
- ② Starting $T_J = 25^\circ\text{C}$, $L = 12\text{mH}$
 $R_G = 25\Omega, I_{AS} = 4.1A$.
- ③ $I_{SD} \leq 4.1A, di/dt \leq 92A/\mu s, V_{DD} \leq V_{(BR)DSS}, T_J \leq 150^\circ\text{C}$
- ④ Pulse width $\leq 300\mu s$; duty cycle $\leq 2\%$.
- ⑤ Surface mounted on 1 in square Cu board

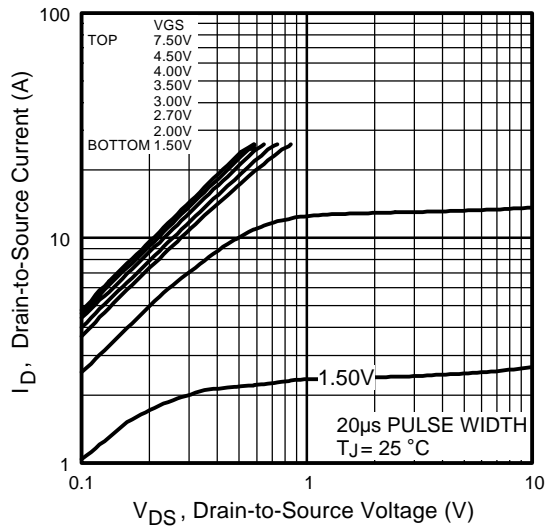

Fig 1. Typical Output Characteristics

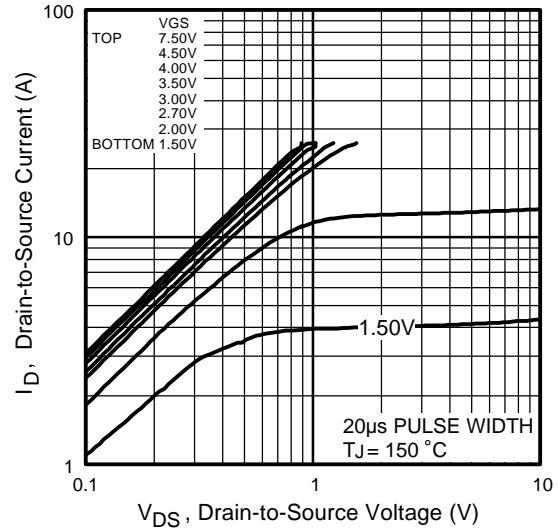

Fig 2. Typical Output Characteristics

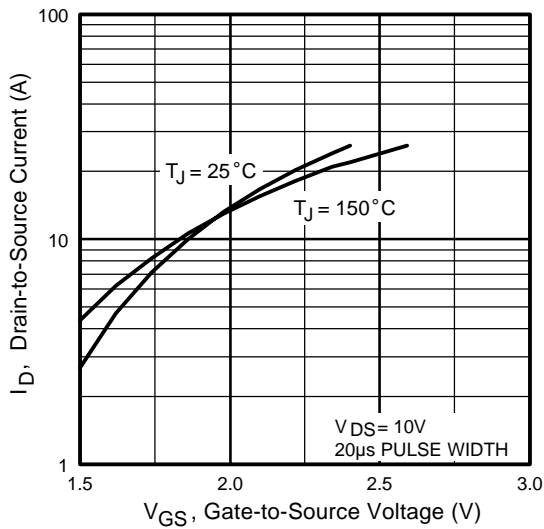

Fig 3. Typical Transfer Characteristics

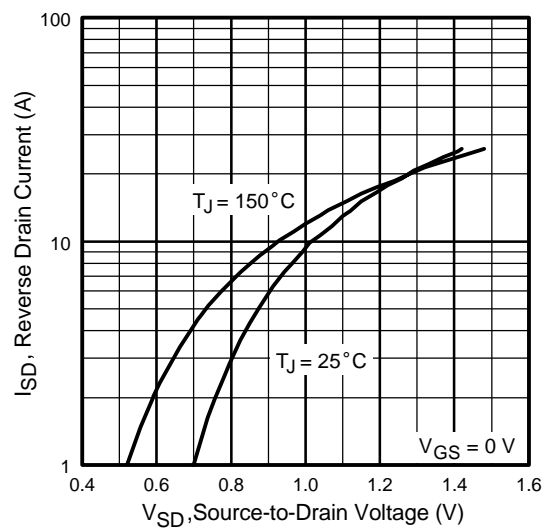

Fig 4. Typical Source-Drain Diode Forward Voltage

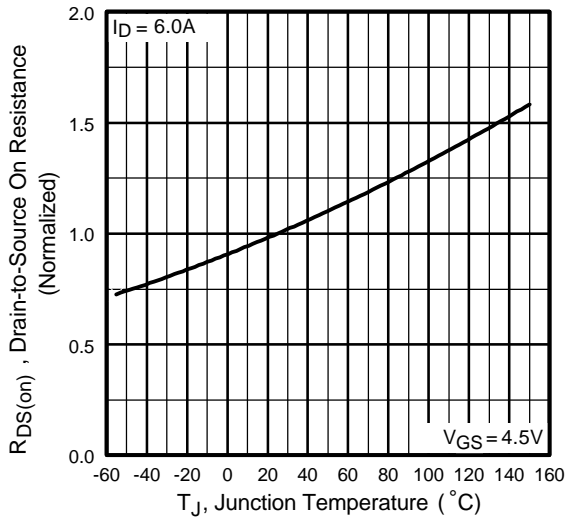

Fig 5. Normalized On-Resistance Vs. Temperature

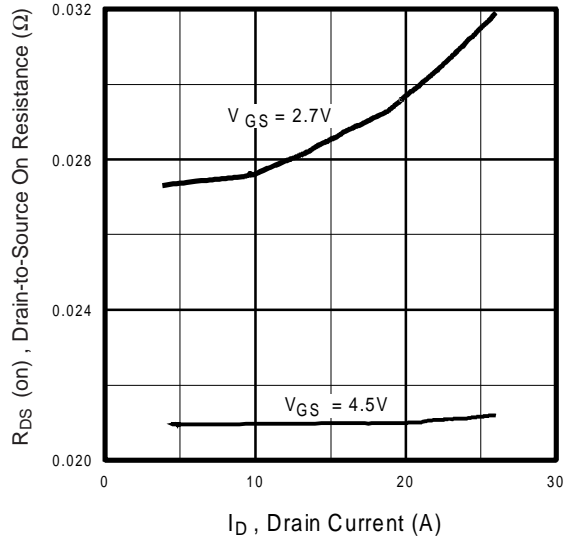

Fig 6. Typical On-Resistance Vs. Drain Current

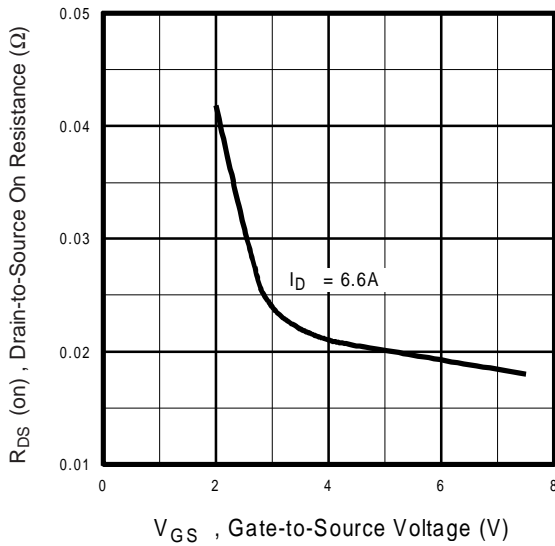

Fig 7. Typical On-Resistance Vs. Gate Voltage

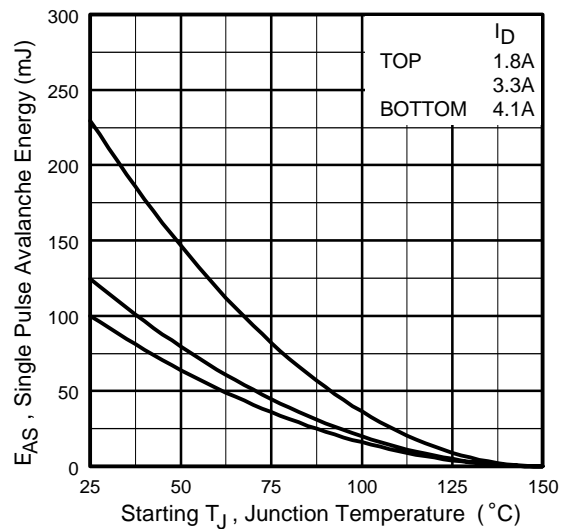

Fig 8. Maximum Avalanche Energy Vs. Drain Current

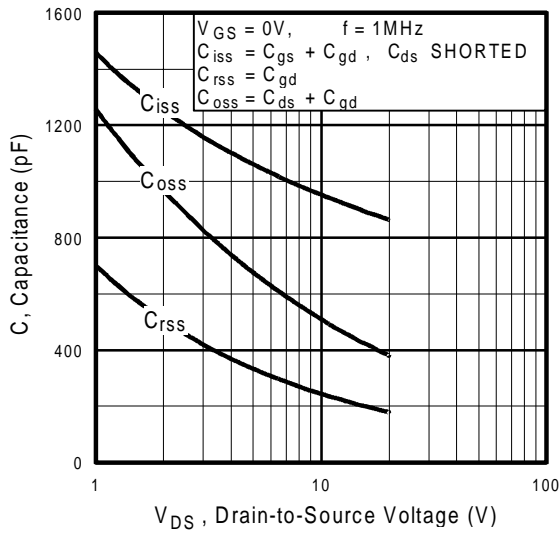

Fig 9. Typical Capacitance Vs. Drain-to-Source Voltage

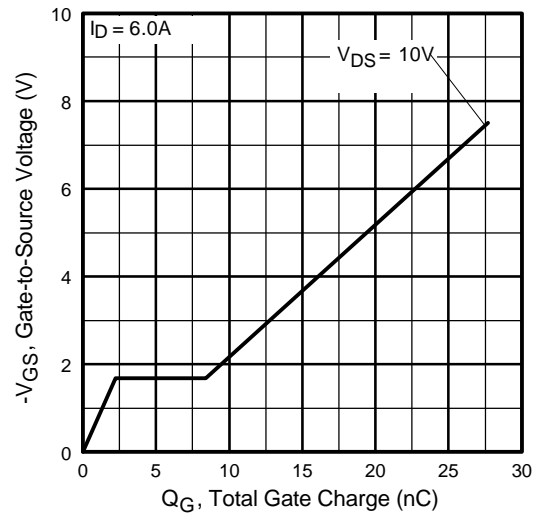

Fig 10. Typical Gate Charge Vs. Gate-to-Source Voltage

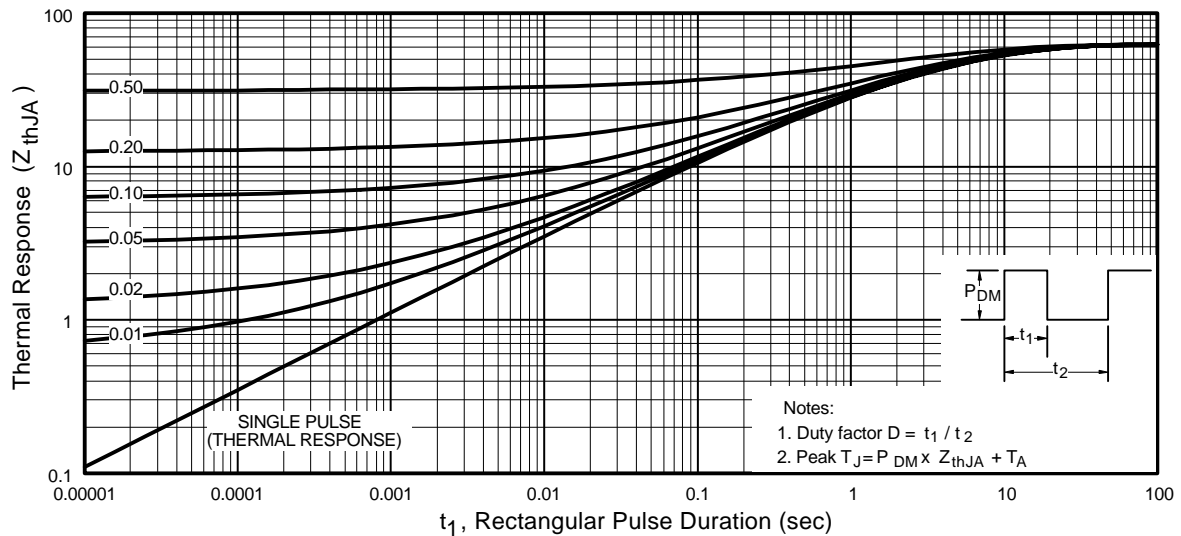
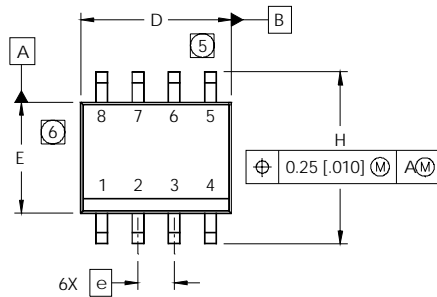
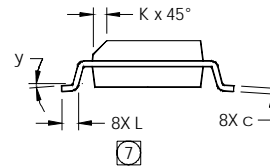
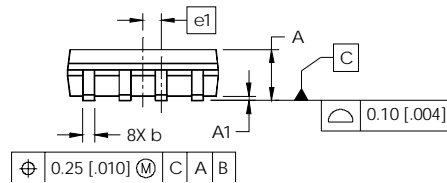

Fig 11. Maximum Effective Transient Thermal Impedance, Junction-to-Ambient

SO-8 Package Details



DIM	INCHES		MILLIMETERS	
	MIN	MAX	MIN	MAX
A	.0532	.0688	1.35	1.75
A1	.0040	.0098	0.10	0.25
b	.013	.020	0.33	0.51
c	.0075	.0098	0.19	0.25
D	.189	.1968	4.80	5.00
E	.1497	.1574	3.80	4.00
e	.050 BASIC		1.27 BASIC	
e1	.025 BASIC		0.635 BASIC	
H	.2284	.2440	5.80	6.20
K	.0099	.0196	0.25	0.50
L	.016	.050	0.40	1.27
y	0°	8°	0°	8°



NOTES:

1. DIMENSIONING & TOLERANCING PER ASME Y14.5M-1994.
2. CONTROLLING DIMENSION: MILLIMETER
3. DIMENSIONS ARE SHOWN IN MILLIMETERS [INCHES].
4. OUTLINE CONFORMS TO JEDEC OUTLINE MS-012AA.
- ⑤ DIMENSION DOES NOT INCLUDE MOLD PROTRUSIONS. MOLD PROTRUSIONS NOT TO EXCEED 0.15 [0.006].
- ⑥ DIMENSION DOES NOT INCLUDE MOLD PROTRUSIONS. MOLD PROTRUSIONS NOT TO EXCEED 0.25 [0.010].
- ⑦ DIMENSION IS THE LENGTH OF LEAD FOR SOLDERING TO A SUBSTRATE.

FOOTPRINT

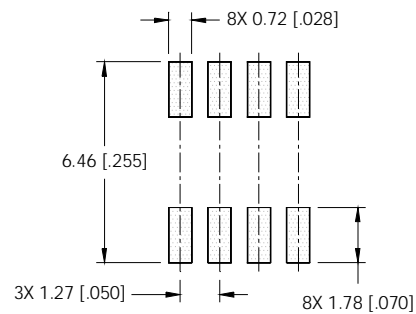

SO-8 Part Marking

EXAMPLE: THIS IS AN IRF7101 (MOSFET)

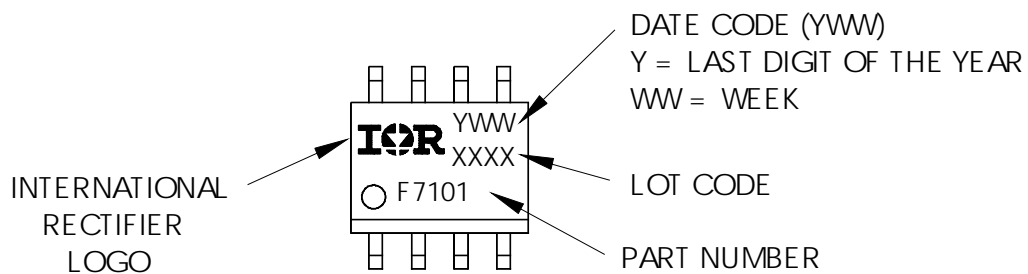



IRF7311

SO-8 Tape and Reel

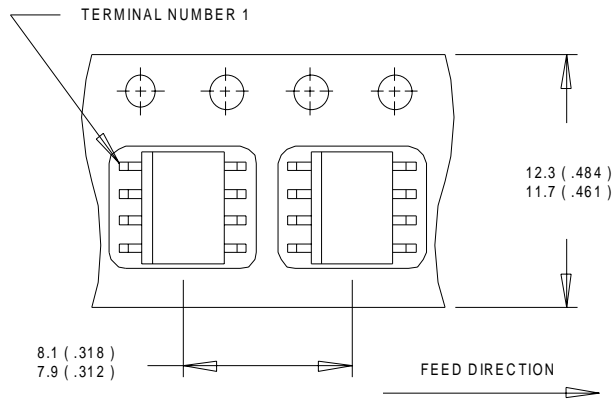

- NOTES:
1. CONTROLLING DIMENSION : MILLIMETER.
 2. ALL DIMENSIONS ARE SHOWN IN MILLIMETERS(INCHES).
 3. OUTLINE CONFORMS TO EIA-481 & EIA-541.

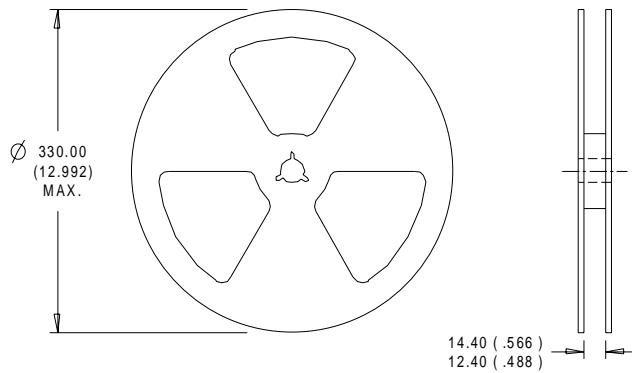

- NOTES :
1. CONTROLLING DIMENSION : MILLIMETER.
 2. OUTLINE CONFORMS TO EIA-481 & EIA-541.