

**HEXFET® POWER MOSFET  
 THRU-HOLE (TO-257AA)**

**IRF5Y5305CM  
 55V, P-CHANNEL**

**Product Summary**

Part Number	BV <sub>DSS</sub>	R <sub>DS(on)</sub>	I <sub>D</sub>
IRF5Y5305CM	-55V	0.065Ω	-18A*

Fifth Generation HEXFET® power MOSFETs from International Rectifier utilize advanced processing techniques to achieve the lowest possible on-resistance per silicon unit area. This benefit, combined with the fast switching speed and ruggedized device design that HEXFET power MOSFETs are well known for, provides the designer with an extremely efficient device for use in a wide variety of applications.

These devices are well-suited for applications such as switching power supplies, motor controls, inverters, choppers, audio amplifiers and high-energy pulse circuits.

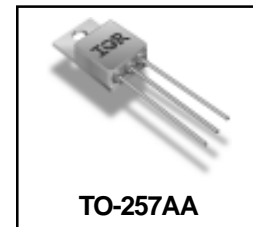

**TO-257AA**

**Features:**

- Low R<sub>DS(on)</sub>
- Avalanche Energy Ratings
- Dynamic dv/dt Rating
- Simple Drive Requirements
- Ease of Paralleling
- Hermetically Sealed
- Light Weight

**Absolute Maximum Ratings**

	Parameter		Units
I <sub>D</sub> @ V <sub>GS</sub> = -10V, T <sub>C</sub> = 25°C	Continuous Drain Current	-18*	A
I <sub>D</sub> @ V <sub>GS</sub> = -10V, T <sub>C</sub> = 100°C	Continuous Drain Current	-15	
I <sub>DM</sub>	Pulsed Drain Current ①	-72	
P <sub>D</sub> @ T <sub>C</sub> = 25°C	Max. Power Dissipation	75	W
	Linear Derating Factor	0.6	W/°C
V <sub>GS</sub>	Gate-to-Source Voltage	±20	V
EAS	Single Pulse Avalanche Energy ②	160	mJ
I <sub>AR</sub>	Avalanche Current ①	-16	A
EAR	Repetitive Avalanche Energy ①	7.5	mJ
dv/dt	Peak Diode Recovery dv/dt ③	3.0	V/ns
T <sub>J</sub>	Operating Junction	-55 to 150	°C
T <sub>STG</sub>	Storage Temperature Range		
	Lead Temperature	300 (0.063in./1.6mm from case for 10sec)	
	Weight	4.3 (Typical)	g

\* Current is limited by package

For footnotes refer to the last page

**Electrical Characteristics @ T<sub>j</sub> = 25°C (Unless Otherwise Specified)**

	Parameter	Min	Typ	Max	Units	Test Conditions
BV <sub>DSS</sub>	Drain-to-Source Breakdown Voltage	-55	—	—	V	V <sub>GS</sub> = 0V, I <sub>D</sub> = -250μA
ΔBV <sub>DSS</sub> /ΔT <sub>J</sub>	Temperature Coefficient of Breakdown Voltage	—	-0.053	—	V/°C	Reference to 25°C, I <sub>D</sub> = -1.0mA
R <sub>DS(on)</sub>	Static Drain-to-Source On-State Resistance	—	—	0.065	Ω	V <sub>GS</sub> = 10V, I <sub>D</sub> = -15A ④
V <sub>GS(th)</sub>	Gate Threshold Voltage	-2.0	—	-4.0	V	V <sub>DS</sub> = V <sub>GS</sub> , I <sub>D</sub> = -250μA
g <sub>fs</sub>	Forward Transconductance	8.0	—	—	S (r <sub>θ</sub> )	V <sub>DS</sub> = -25V, I <sub>DS</sub> = -16A ④
I <sub>DSS</sub>	Zero Gate Voltage Drain Current	—	—	-25	μA	V <sub>DS</sub> = -55V, V <sub>GS</sub> = 0V
		—	—	-250		V <sub>DS</sub> = -44V, V <sub>GS</sub> = 0V, T <sub>J</sub> = 125°C
I <sub>GSS</sub>	Gate-to-Source Leakage Forward	—	—	-100	nA	V <sub>GS</sub> = -20V
I <sub>GSS</sub>	Gate-to-Source Leakage Reverse	—	—	100		V <sub>GS</sub> = 20V
Q <sub>g</sub>	Total Gate Charge	—	—	70	nC	V <sub>GS</sub> = -10V, I <sub>D</sub> = -16A V <sub>DS</sub> = -44V
Q <sub>gs</sub>	Gate-to-Source Charge	—	—	17		
Q <sub>gd</sub>	Gate-to-Drain ('Miller') Charge	—	—	30		
t <sub>d(on)</sub>	Turn-On Delay Time	—	—	26	ns	V <sub>DD</sub> = -28V, I <sub>D</sub> = -16A, R <sub>G</sub> = 7.5Ω
t <sub>r</sub>	Rise Time	—	—	125		
t <sub>d(off)</sub>	Turn-Off Delay Time	—	—	56		
t <sub>f</sub>	Fall Time	—	—	74		
L <sub>S</sub> + L <sub>D</sub>	Total Inductance	—	6.8	—	nH	Measured from drain lead (6mm/ 0.25in. from package) to source lead (6mm/0.25in. from package)
C <sub>iss</sub>	Input Capacitance	—	1290	—	pF	V <sub>GS</sub> = 0V, V <sub>DS</sub> = -25V f = 1.0MHz
C <sub>oss</sub>	Output Capacitance	—	495	—		
C <sub>rss</sub>	Reverse Transfer Capacitance	—	203	—		

**Source-Drain Diode Ratings and Characteristics**

	Parameter	Min	Typ	Max	Units	Test Conditions
I <sub>S</sub>	Continuous Source Current (Body Diode)	—	—	-18*	A	
I <sub>SM</sub>	Pulse Source Current (Body Diode) ①	—	—	-72		
V <sub>SD</sub>	Diode Forward Voltage	—	—	-1.3	V	T <sub>j</sub> = 25°C, I <sub>S</sub> = -15A, V <sub>GS</sub> = 0V ④
t <sub>rr</sub>	Reverse Recovery Time	—	—	100	ns	T <sub>j</sub> = 25°C, I <sub>F</sub> = -16A, di/dt ≥ 100A/μs
Q <sub>RR</sub>	Reverse Recovery Charge	—	—	250	nC	V <sub>DD</sub> ≤ -30V ④
t <sub>on</sub>	Forward Turn-On Time	Intrinsic turn-on time is negligible. Turn-on speed is substantially controlled by L <sub>S</sub> + L <sub>D</sub> .				

\* Current is limited by package

**Thermal Resistance**

	Parameter	Min	Typ	Max	Units	Test Conditions
R <sub>thJC</sub>	Junction-to-Case	—	—	1.67	°C/W	

Note: Corresponding Spice and Saber models are available on the G&S Website.

For footnotes refer to the last page

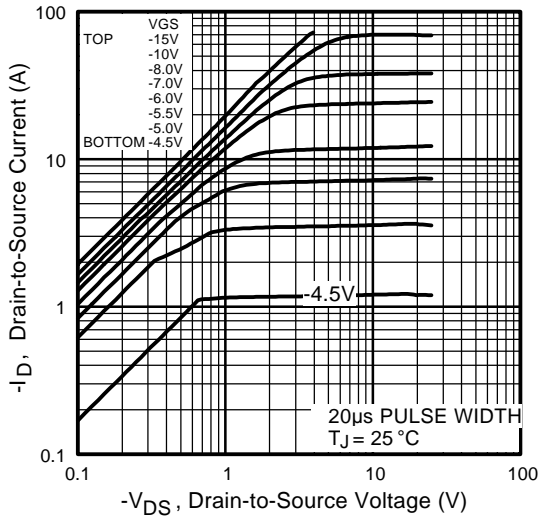

**Fig 1.** Typical Output Characteristics

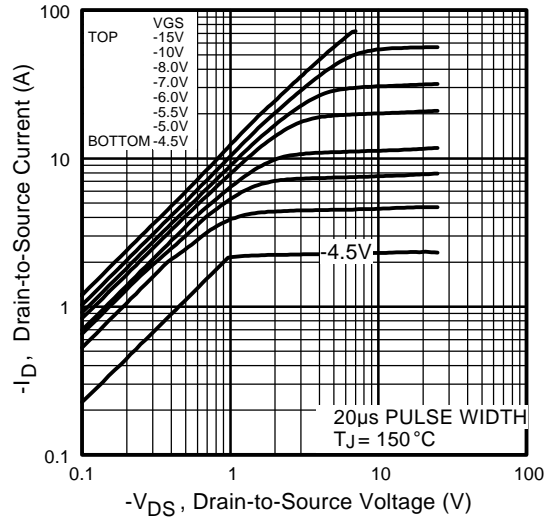

**Fig 2.** Typical Output Characteristics

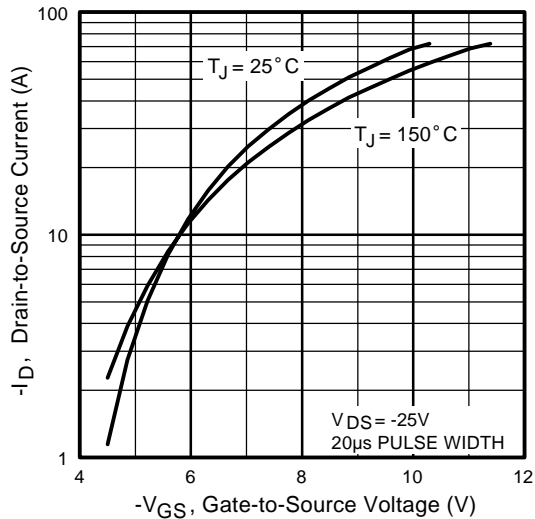

**Fig 3.** Typical Transfer Characteristics

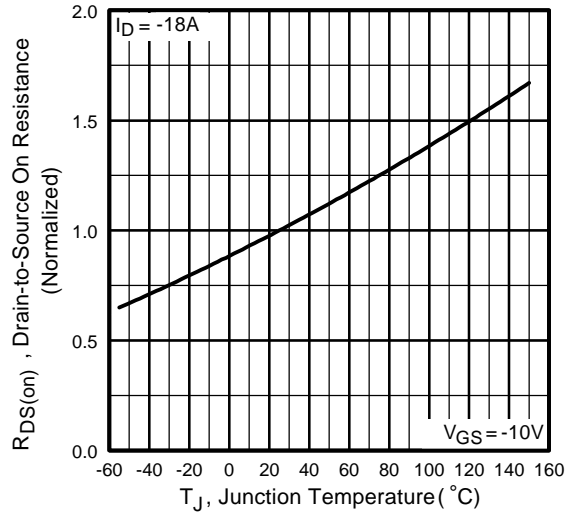

**Fig 4.** Normalized On-Resistance Vs. Temperature

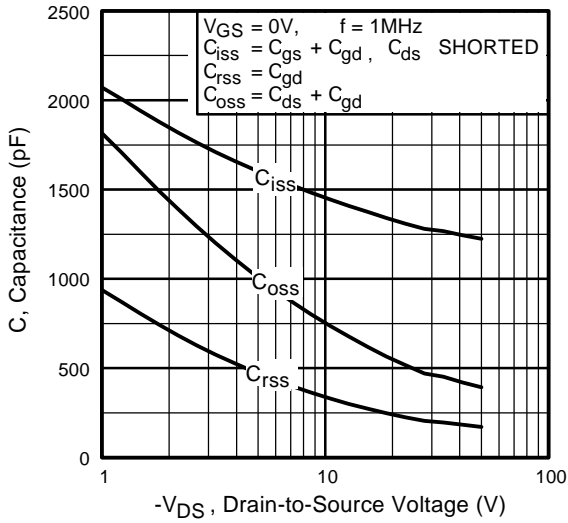

**Fig 5.** Typical Capacitance Vs. Drain-to-Source Voltage

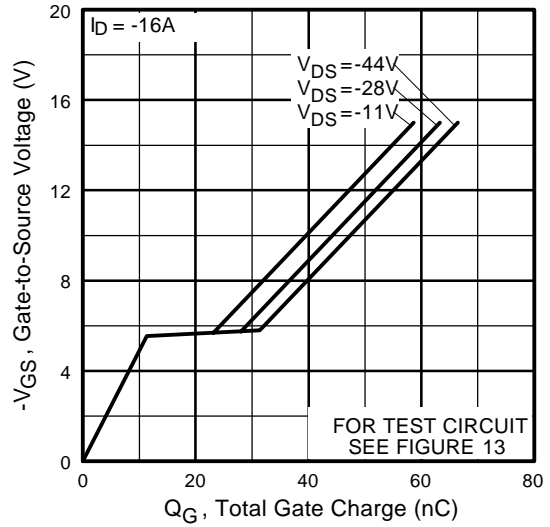

**Fig 6.** Typical Gate Charge Vs. Gate-to-Source Voltage

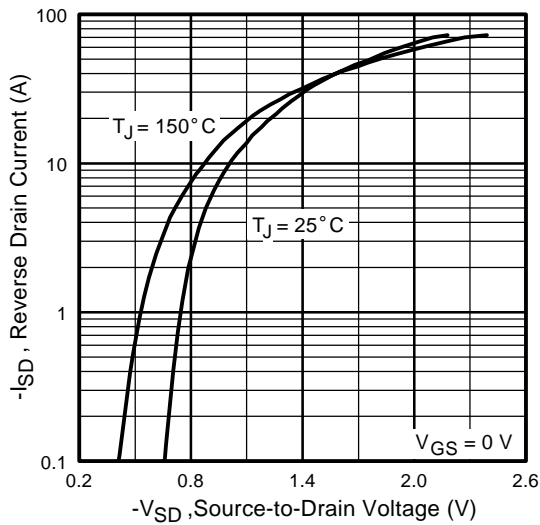

**Fig 7.** Typical Source-Drain Diode Forward Voltage

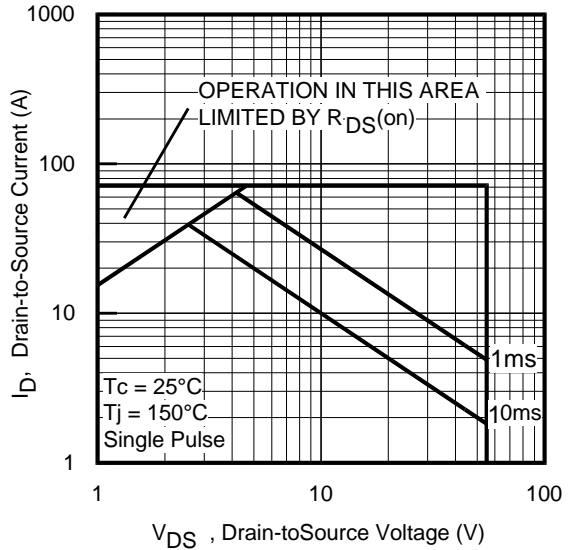

**Fig 8.** Maximum Safe Operating Area

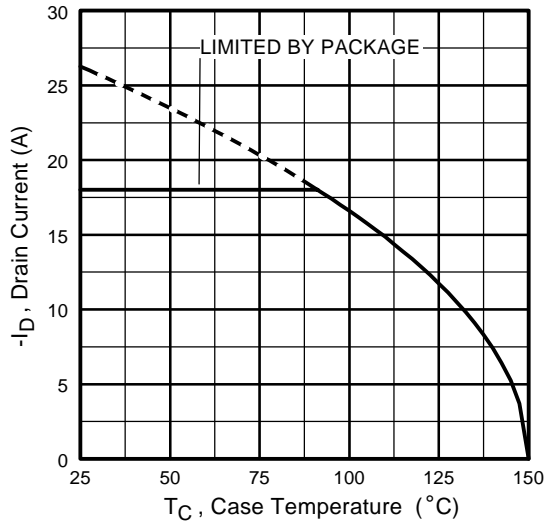

**Fig 9.** Maximum Drain Current Vs. Case Temperature

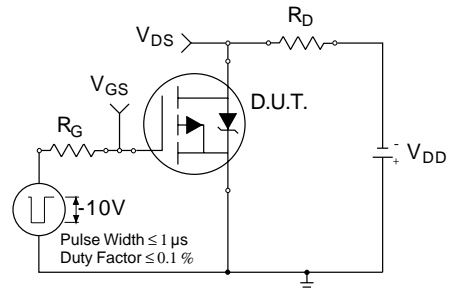

**Fig 10a.** Switching Time Test Circuit

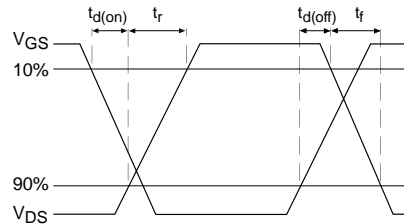

**Fig 10b.** Switching Time Waveforms

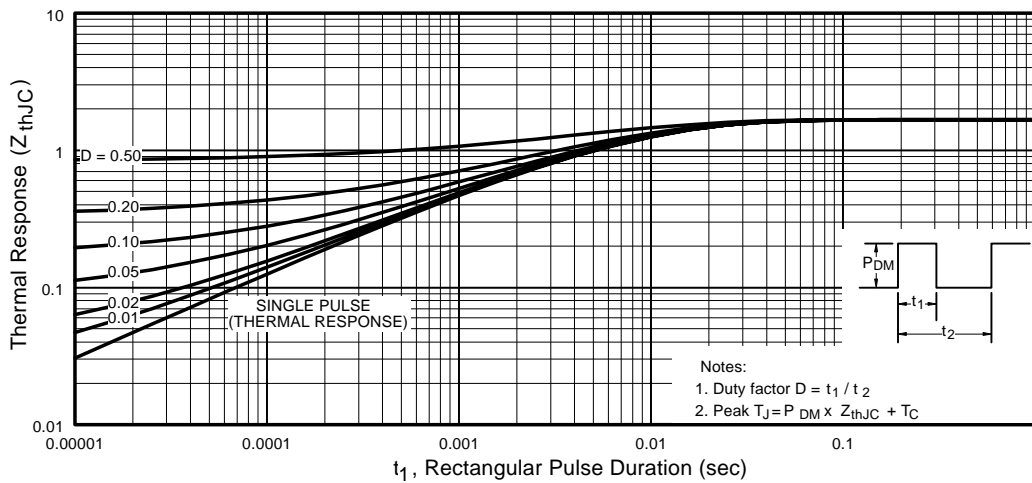

**Fig 11.** Maximum Effective Transient Thermal Impedance, Junction-to-Case

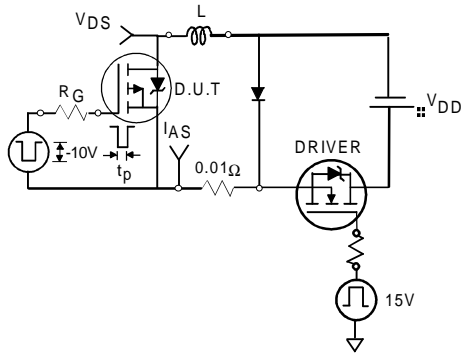

**Fig 12a.** Unclamped Inductive Test Circuit

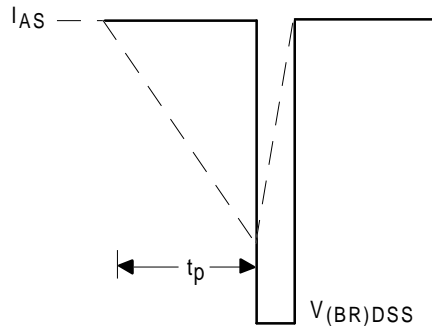

**Fig 12b.** Unclamped Inductive Waveforms

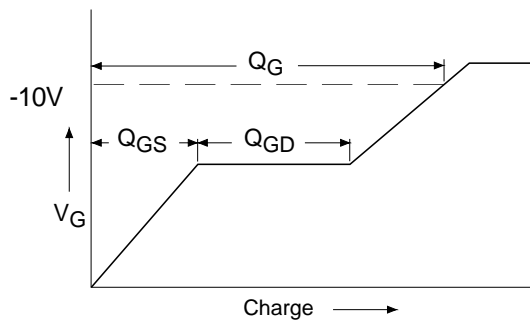

**Fig 13a.** Basic Gate Charge Waveform

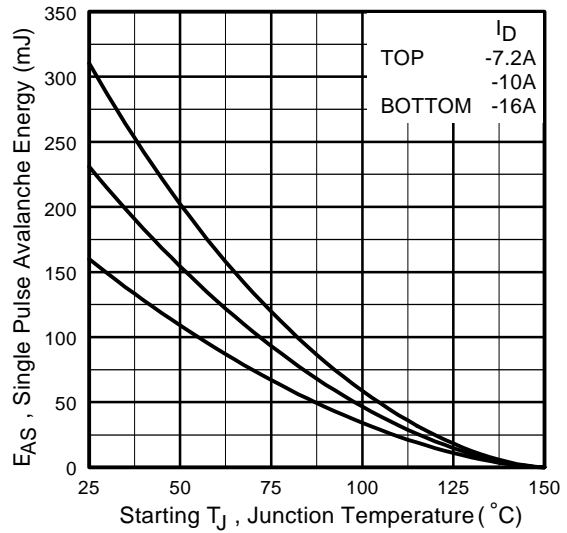

**Fig 12c.** Maximum Avalanche Energy Vs. Drain Current

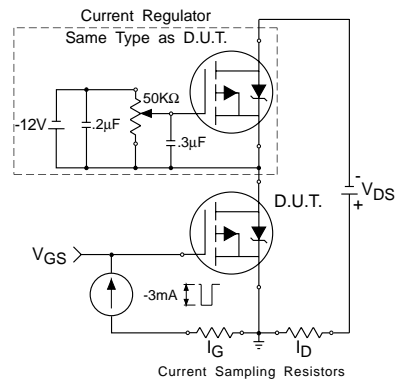
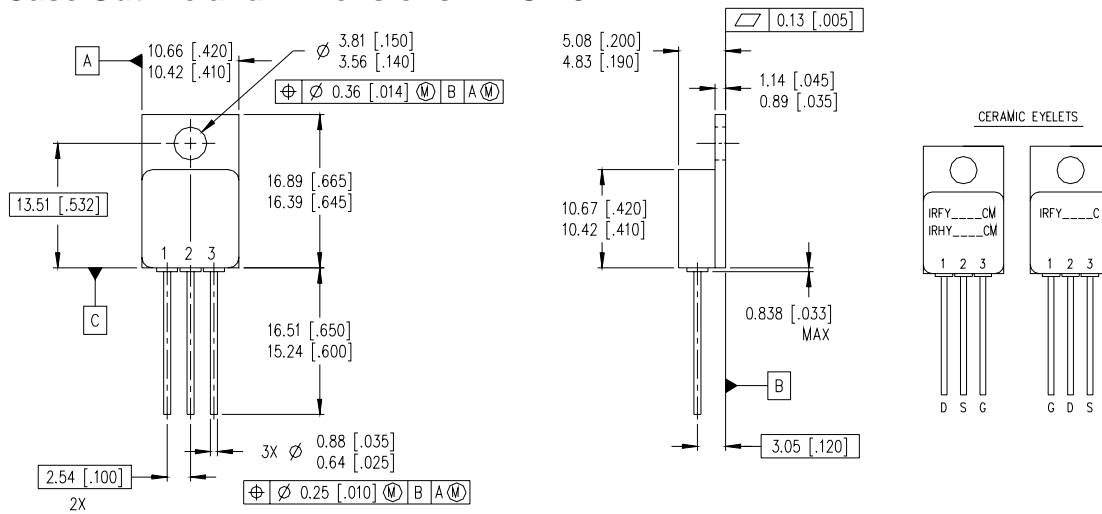

**Fig 13b.** Gate Charge Test Circuit

**Footnotes:**

- ① Repetitive Rating; Pulse width limited by maximum junction temperature.
- ②  $V_{DD} = -25\text{ V}$ , Starting  $T_J = 25^\circ\text{C}$ ,  $L = 1.3\text{mH}$   
Peak  $I_{AS} = -16\text{A}$ ,  $R_G = 25\Omega$
- ③  $I_{SD} \leq -16\text{A}$ ,  $di/dt \leq -213\text{ A}/\mu\text{s}$ ,  
 $V_{DD} \leq -55\text{V}$ ,  $T_J \leq 150^\circ\text{C}$
- ④ Pulse width  $\leq 400\ \mu\text{s}$ ; Duty Cycle  $\leq 2\%$

**Case Outline and Dimensions — TO-257AA**



**NOTES:**

1. DIMENSIONING & TOLERANCING PER ANSI Y14.5M-1994.
2. CONTROLLING DIMENSION: INCH.
3. DIMENSIONS ARE SHOWN IN MILLIMETERS [INCHES].
4. OUTLINE CONFORMS TO JEDEC OUTLINE TO-257AA.

**LEGEND**

- D - DRAIN
- S - SOURCE
- G - GATE

**IR WORLD HEADQUARTERS:** 233 Kansas St., El Segundo, California 90245, USA Tel: (310) 252-7105  
**IR EUROPEAN REGIONAL CENTRE:** 439/445 Godstone Rd, Whyteleafe, Surrey CR3 OBL, UK Tel: ++ 44 (0)20 8645 8000  
**IR CANADA:** 15 Lincoln Court, Brampton, Ontario L6T3Z2, Tel: (905) 453 2200  
**IR GERMANY:** Saalburgstrasse 157, 61350 Bad Homburg Tel: ++ 49 (0) 6172 96590  
**IR ITALY:** Via Liguria 49, 10071 Borgaro, Torino Tel: ++ 39 011 451 0111  
**IR JAPAN:** K&H Bldg., 2F, 30-4 Nishi-Ikebukuro 3-Chome, Toshima-Ku, Tokyo 171 Tel: 81 (0)3 3983 0086  
**IR SOUTHEAST ASIA:** 1 Kim Seng Promenade, Great World City West Tower, 13-11, Singapore 237994 Tel: ++ 65 (0)838 4630  
**IR TAIWAN:** 16 Fl. Suite D. 207, Sec. 2, Tun Haw South Road, Taipei, 10673 Tel: 886-(0)2 2377 9936  
*Data and specifications subject to change without notice. 11/00*