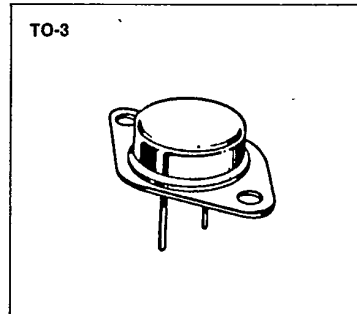

98 DE 7964142 0005099 4

**IRF240/241/242/243****N-CHANNEL  
POWER MOSFETS****FEATURES**

- Low  $R_{DS(on)}$
- Improved inductive ruggedness
- Fast switching times
- Rugged polysilicon gate cell structure
- Low input capacitance
- Extended safe operating area
- Improved high temperature reliability
- TO-3 package (Standard)

**PRODUCT SUMMARY**

Part Number	$V_{DS}$	$R_{DS(on)}$	$I_D$
IRF240	200V	0.18 $\Omega$	18A
IRF241	150V	0.18 $\Omega$	18A
IRF242	200V	0.22 $\Omega$	16A
IRF243	150V	0.22 $\Omega$	16A

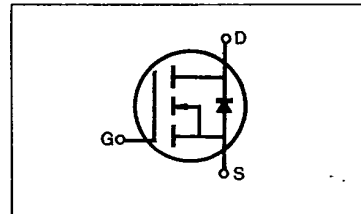
**MAXIMUM RATINGS**

Characteristic	Symbol	IRF240	IRF241	IRF242	IRF243	Unit
Drain-Source Voltage (1)	$V_{DSS}$	200	150	200	150	Vdc
Drain-Gate Voltage ( $R_{GS}=1.0M\Omega$ ) (1)	$V_{DGR}$	200	150	200	150	Vdc
Gate-Source Voltage	$V_{GS}$	$\pm 20$				Vdc
Continuous Drain Current $T_C=25^\circ C$	$I_D$	18	18	16	16	Adc
Continuous Drain Current $T_C=100^\circ C$	$I_D$	11	11	10	10	Adc
Drain Current—Pulsed (3)	$I_{DM}$	72	72	64	64	Adc
Gate Current—Pulsed	$I_{GM}$	$\pm 1.5$				Adc
Total Power Dissipation @ $T_C=25^\circ C$	$P_D$	125				Watts
Derate above $25^\circ C$		1.0				$W/^\circ C$
Operating and Storage Junction Temperature Range	$T_J, T_{stg}$	-55 to 150				$^\circ C$
Maximum Lead Temp. for Soldering Purposes, 1/8" from case for 5 seconds	$T_L$	300				$^\circ C$

Notes: (1)  $T_J=25^\circ C$  to  $150^\circ C$ (2) Pulse test: Pulse width  $\leq 300\mu s$ , Duty Cycle  $\leq 2\%$ 

(3) Repetitive rating: Pulse width limited by max. junction temperature

ELECTRICAL CHARACTERISTICS (T<sub>c</sub>=25°C unless otherwise specified).

Characteristic	Symbol	Type	Min	Typ	Max	Units	Test Conditions
Drain-Source Breakdown Voltage	BV <sub>DSS</sub>	IRF240 IRF242	200	—	—	V	V <sub>GS</sub> =0V
		IRF241 IRF243	150	—	—	V	I <sub>D</sub> =250μA
Gate Threshold Voltage	V <sub>GS(th)</sub>	ALL	2.0	—	4.0	V	V <sub>DS</sub> =V <sub>GS</sub> , I <sub>D</sub> =250μA
Gate-Source Leakage Forward	I <sub>GSS</sub>	ALL	—	—	100	nA	V <sub>GS</sub> =20V
Gate-Source Leakage Reverse	I <sub>GSS</sub>	ALL	—	—	-100	nA	V <sub>GS</sub> =-20V
Zero Gate Voltage Drain Current	I <sub>DSS</sub>	ALL	—	—	250	μA	V <sub>DS</sub> =Max. Rating, V <sub>GS</sub> =0V
			—	—	1000	μA	V <sub>DS</sub> =Max. Rating×0.8, V <sub>GS</sub> =0V, T <sub>c</sub> =125°C
On-State Drain-Source Current (2)	I <sub>D(on)</sub>	IRF240 IRF241	18	—	—	A	V <sub>DS</sub> >I <sub>D(on)</sub> ×R <sub>DS(on)</sub> max., V <sub>GS</sub> =10V
		IRF242 IRF243	16	—	—	A	
Static Drain-Source On-State Resistance (2)	R <sub>DS(on)</sub>	IRF240 IRF241	—	0.13	0.18	Ω	V <sub>GS</sub> =10V, I <sub>D</sub> =10A
		IRF242 IRF243	—	0.20	0.22	Ω	
Forward Transconductance (2)	g <sub>fs</sub>	ALL	6.0	9.5	—	Ω	V <sub>DS</sub> >I <sub>D(on)</sub> ×R <sub>DS(on)</sub> max., I <sub>D</sub> =10A
Input Capacitance	C <sub>iss</sub>	ALL	—	1200	1600	pF	V <sub>GS</sub> =0V, V <sub>DS</sub> =25V, f=1.0MHz
Output Capacitance	C <sub>oss</sub>	ALL	—	360	750	pF	
Reverse Transfer Capacitance	C <sub>rss</sub>	ALL	—	130	300	pF	
Turn-On Delay Time	t <sub>d(on)</sub>	ALL	—	—	30	ns	V <sub>DD</sub> =0.5BV <sub>DSS</sub> , I <sub>D</sub> =10A, Z <sub>0</sub> =4.7 Ω (MOSFET switching times are essentially independent of operating temperature.)
Rise Time	t <sub>r</sub>	ALL	—	—	60	ns	
Turn-Off Delay Time	t <sub>d(off)</sub>	ALL	—	—	80	ns	
Fall Time	t <sub>f</sub>	ALL	—	—	60	ns	
Total Gate Charge (Gate-Source Plus Gate-Drain)	Q <sub>g</sub>	ALL	—	44	60	nC	V <sub>GS</sub> =10V, I <sub>D</sub> =22A, V <sub>DS</sub> =0.8 Max. Rating (Gate charge is essentially independent of operating temperature.)
Gate-Source Charge	Q <sub>gs</sub>	ALL	—	9	—	nC	
Gate-Drain ("Miller") Charge	Q <sub>gd</sub>	ALL	—	35	—	nC	

## THERMAL RESISTANCE

Junction-to-Case	R <sub>thJC</sub>	ALL	—	—	1.0	K/W	
Case-to-Sink	R <sub>thCS</sub>	ALL	—	0.1	—	K/W	Mounting surface flat, smooth, and greased
Junction-to-Ambient	R <sub>thJA</sub>	ALL	—	—	30	K/W	Free Air Operation

- Notes: (1) T<sub>J</sub>=25°C to 150°C  
(2) Pulse test: Pulse width≤300μs, Duty Cycle≤2%  
(3) Repetitive rating: Pulse width limited by max. junction temperature

**IRF240/241/242/243**

**N-CHANNEL  
POWER MOSFETS**

**SOURCE-DRAIN DIODE RATINGS AND CHARACTERISTICS**

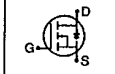
Characteristic	Symbol	Type	Min	Typ	Max	Units	Test Conditions
Continuous Source Current (Body Diode)	I <sub>S</sub>	IRF240	—	—	18	A	Modified MOSFET symbol showing the integral reverse P-N junction rectifier 
		IRF241	—	—	16	A	
		IRF242 IRF243	—	—	16	A	
Pulse Source Current (Body Diode) (3)	I <sub>SM</sub>	IRF240	—	—	72	A	
		IRF241	—	—	64	A	
		IRF242 IRF243	—	—	64	A	
Diode Forward Voltage (2)	V <sub>SD</sub>	IRF240	—	—	2.0	V	T <sub>C</sub> =25°C, I <sub>S</sub> =18A, V <sub>GS</sub> =0V
		IRF241	—	—	2.0	V	T <sub>C</sub> =25°C, I <sub>S</sub> =16A, V <sub>GS</sub> =0V
		IRF242 IRF243	—	—	1.9	V	T <sub>C</sub> =25°C, I <sub>S</sub> =16A, V <sub>GS</sub> =0V
Reverse Recovery Time	t <sub>rr</sub>	ALL	—	650	—	ns	T <sub>J</sub> =150°C, I <sub>F</sub> =18A, dI <sub>F</sub> /dt=100A/μs

Notes: (1) T<sub>J</sub>=25°C to 150°C (2) Pulse test: Pulse width ≤ 300μs, Duty Cycle ≤ 2%  
 (3) Repetitive rating: Pulse width limited by max. junction temperature

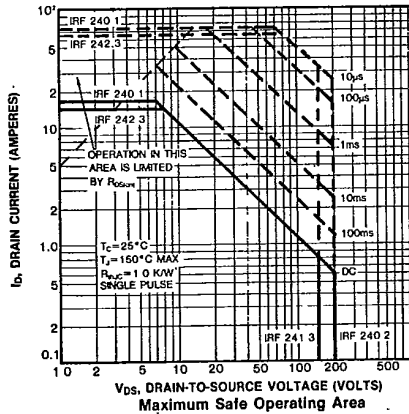
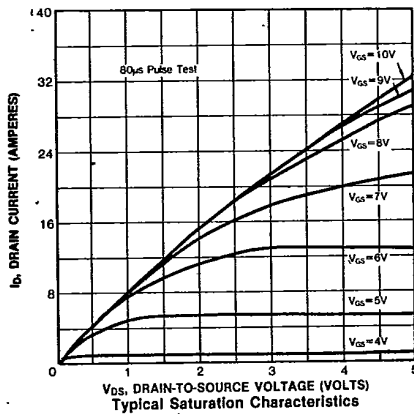
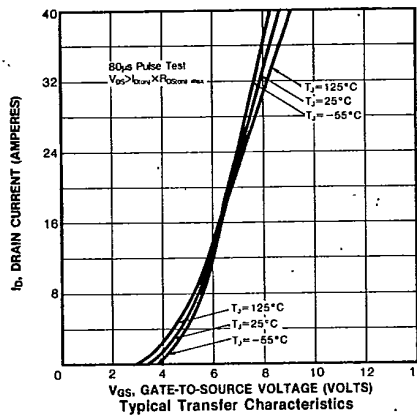
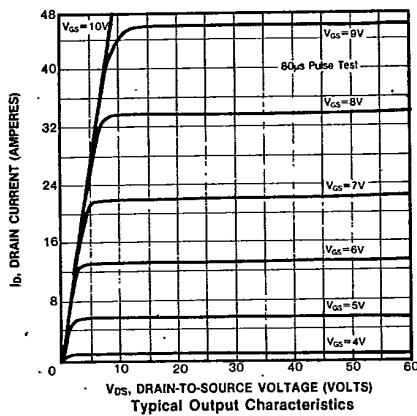

98 DE 7964142 0005102 0  
**IRF240/241/242/243**

**N-CHANNEL  
 POWER MOSFETS**

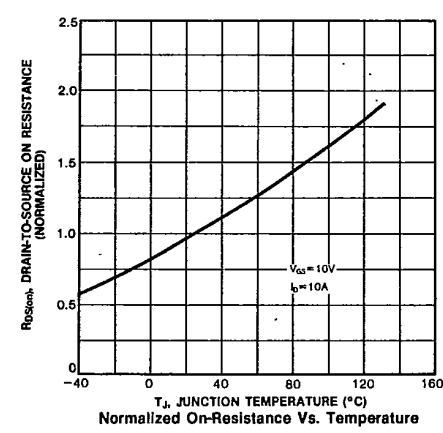
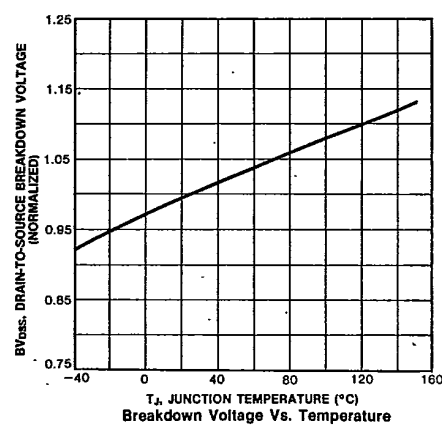
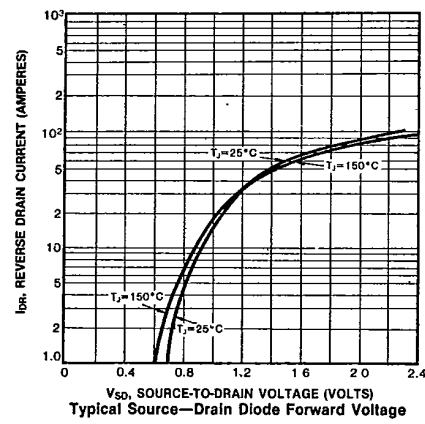
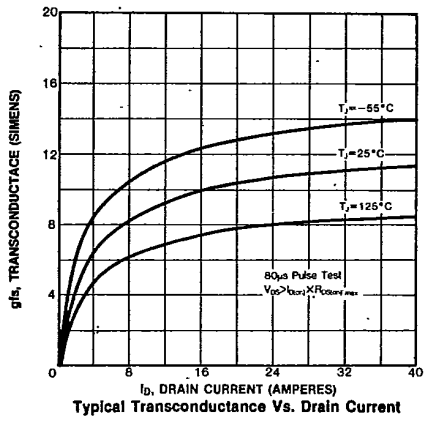
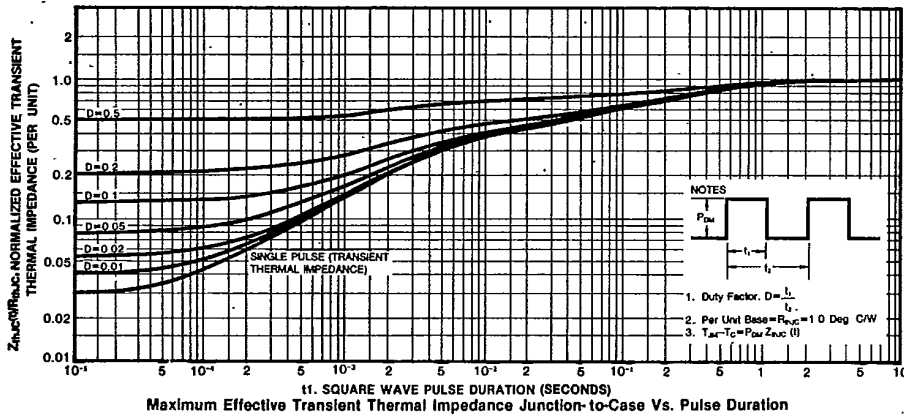

IRF240/241/242/243

N-CHANNEL  
POWER MOSFETS

