

N-CHANNEL POWER MOSFETS

IRF230/231/232/233

FEATURES

- Low $R_{DS(on)}$
- Improved inductive ruggedness
- Fast switching times
- Rugged polysilicon gate cell structure
- Low input capacitance
- Extended safe operating area
- Improved high temperature reliability
- TO-3 package (Standard)

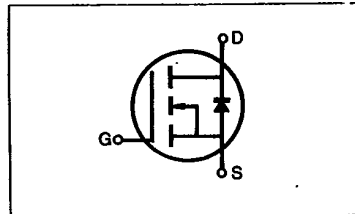
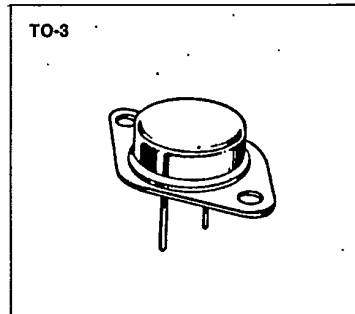

PRODUCT SUMMARY

Part Number	V_{DS}	$R_{DS(on)}$	I_D
IRF230	200V	0.4 Ω	9.0A
IRF231	150V	0.4 Ω	9.0A
IRF232	200V	0.6 Ω	8.0A
IRF233	150V	0.6 Ω	8.0A

MAXIMUM RATINGS

Characteristic	Symbol	IRF230	IRF231	IRF232	IRF233	Unit
Drain-Source Voltage (1)	V_{DSS}	200	150	200	150	Vdc
Drain-Gate Voltage ($R_{GS}=1.0M\Omega$) (1)	V_{DGR}	200	150	200	150	Vdc
Gate-Source Voltage	V_{GS}	± 20				Vdc
Continuous Drain Current $T_C=25^\circ C$	I_D	9.0	9.0	8.0	8.0	Adc
Continuous Drain Current $T_C=100^\circ C$	I_D	6.0	6.0	5.0	5.0	Adc
Drain Current—Pulsed (3)	I_{DM}	36	36	32	32	Adc
Gate Current—Pulsed	I_{GM}	± 1.5				Adc
Total Power Dissipation @ $T_C=25^\circ C$ Derate above $25^\circ C$	P_D	75 0.6				Watts W/ $^\circ C$
Operating and Storage Junction Temperature Range	T_J, T_{stg}	-55 to 150				$^\circ C$
Maximum Lead Temp. for Soldering Purposes, 1/8" from case for 5 seconds	T_L	300				$^\circ C$

Notes: (1) $T_J=25^\circ C$ to $150^\circ C$

(2) Pulse test: Pulse width $\leq 300\mu s$, Duty Cycle $\leq 2\%$

(3) Repetitive rating: Pulse width limited by max. junction temperature

**N-CHANNEL
POWER MOSFETS****IRF230/231/232/233****ELECTRICAL CHARACTERISTICS** ($T_C=25^\circ\text{C}$ unless otherwise specified)

Characteristic	Symbol	Type	Min	Typ	Max	Units	Test Conditions
Drain-Source Breakdown Voltage	BV_{DSS}	IRF230	200	—	—	V	$V_{GS}=0V$
		IRF232	—	—	—	V	
		IRF231 IRF233	150	—	—	V	$I_D=250\mu A$
Gate Threshold Voltage	$V_{GS(th)}$	ALL	2.0	—	4.0	V	$V_{DS}=V_{GS}$, $I_D=250\mu A$
Gate-Source Leakage Forward	I_{GSS}	ALL	—	—	100	nA	$V_{GS}=20V$
Gate-Source Leakage Reverse	I_{GSS}	ALL	—	—	-100	nA	$V_{GS}=-20V$
Zero Gate Voltage Drain Current	I_{DSS}	ALL	—	—	250	μA	$V_{DS}=\text{Max. Rating}$, $V_{GS}=0V$
			—	—	1000	μA	$V_{DS}=\text{Max. Rating}\times 0.8$, $V_{GS}=0V$, $T_C=125^\circ\text{C}$
On-State Drain-Source Current (2)	$I_{D(on)}$	IRF230	9.0	—	—	A	$V_{DS}>I_{D(on)}\times R_{DS(on) \text{ max.}}$, $V_{GS}=10V$
		IRF231	—	—	—	A	
		IRF232 IRF233	8.0	—	—	A	
Static Drain-Source On-State Resistance (2)	$R_{DS(on)}$	IRF230	—	0.25	0.4	Ω	$V_{GS}=10V$, $I_D=5.0A$
		IRF231	—	—	—	Ω	
		IRF232 IRF233	—	0.4	0.6	Ω	
Forward Transconductance (2)	g_{fs}	ALL	3.0	4.6	—	Ω	$V_{DS}>I_{D(on)}\times R_{DS(on) \text{ max.}}$, $I_D=5.0A$
Input Capacitance	C_{iss}	ALL	—	720	800	pF	$V_{GS}=0V$, $V_{DS}=25V$, $f=1.0\text{MHz}$
Output Capacitance	C_{oss}	ALL	—	250	450	pF	
Reverse Transfer Capacitance	C_{rss}	ALL	—	60	150	pF	
Turn-On Delay Time	$t_{d(on)}$	ALL	—	—	30	ns	$V_{DD}=0.5BV_{DSS}$, $I_D=5.0A$, $Z_\theta=15\Omega$ (MOSFET switching times are essentially independent of operating temperature.)
Rise Time	t_r	ALL	—	—	50	ns	
Turn-Off Delay Time	$t_{d(off)}$	ALL	—	—	50	ns	
Fall Time	t_f	ALL	—	—	40	ns	
Total Gate Charge (Gate-Source Plus Gate-Drain)	Q_g	ALL	—	19	30	nC	
Gate-Source Charge	Q_{gs}	ALL	—	5.0	—	nC	$V_{GS}=10V$, $I_D=12A$, $V_{DS}=0.8 \text{ Max. Rating}$ (Gate charge is essentially independent of operating temperature.)
Gate-Drain ("Miller") Charge	Q_{gd}	ALL	—	14	—	nC	

THERMAL RESISTANCE

Junction-to-Case	R_{thJC}	ALL	—	—	1.67	K/W	
Case-to-Sink	R_{thCS}	ALL	—	0.1	—	K/W	Mounting surface flat, smooth, and greased
Junction-to-Ambient	R_{thJA}	ALL	—	—	30	K/W	Free Air Operation

Notes: (1) $T_J=25^\circ\text{C}$ to 150°C (2) Pulse test: Pulse width $\leq 300\mu s$, Duty Cycle $\leq 2\%$

(3) Repetitive rating: Pulse width limited by max. junction temperature



IRF230/231/232/233

**N-CHANNEL
POWER MOSFETS**

SOURCE-DRAIN DIODE RATINGS AND CHARACTERISTICS

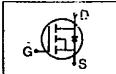
Characteristic	Symbol	Type	Min	Typ	Max	Units	Test Conditions
Continuous Source Current (Body Diode)	I_S	IRF230	—	—	9.0	A	Modified MOSFET symbol showing the integral reverse P-N junction rectifier 
		IRF231	—	—	8.0	A	
		IRF232 IRF233	—	—	8.0	A	
Pulse Source Current (Body Diode) (3)	I_{SM}	IRF230	—	—	36	A	
		IRF231	—	—	32	A	
		IRF232 IRF233	—	—	32	A	
Diode Forward Voltage (2)	V_{SD}	IRF230	—	—	2.0	V	$T_C=25^\circ\text{C}$, $I_S=9.0\text{A}$, $V_{GS}=0\text{V}$
		IRF231	—	—	2.0	V	$T_C=25^\circ\text{C}$, $I_S=8.0\text{A}$, $V_{GS}=0\text{V}$
		IRF232 IRF233	—	—	1.8	V	$T_C=25^\circ\text{C}$, $I_S=8.0\text{A}$, $V_{GS}=0\text{V}$
Reverse Recovery Time	t_{rr}	ALL	—	450	—	ns	$T_J=150^\circ\text{C}$, $I_F=9.0\text{A}$, $di/dt=100\text{A}/\mu\text{s}$

Notes: (1) $T_J=25^\circ\text{C}$ to 150°C (2) Pulse test: Pulse width $\leq 300\mu\text{s}$, Duty Cycle $\leq 2\%$
 (3) Repetitive rating: Pulse width limited by max. junction temperature

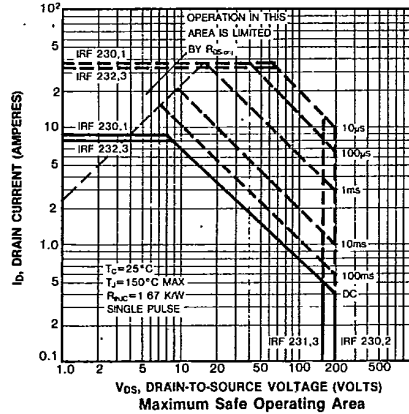
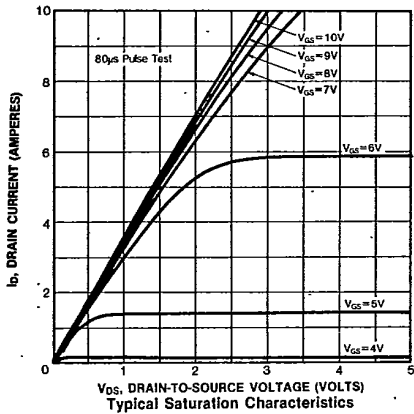
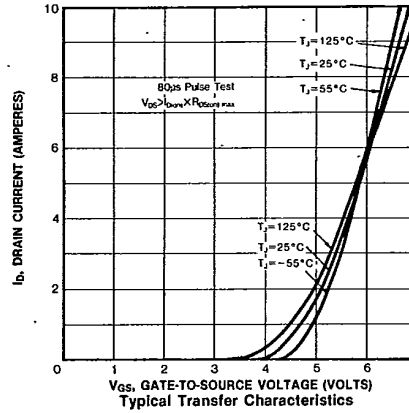
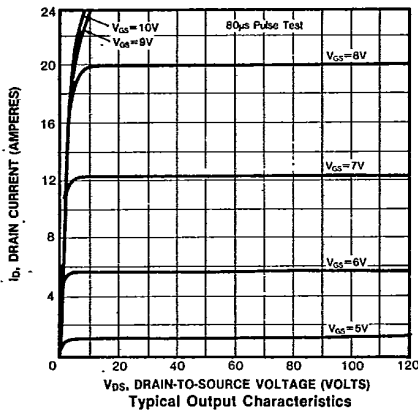

IRF230/231/232/233

**N-CHANNEL
POWER MOSFETS**

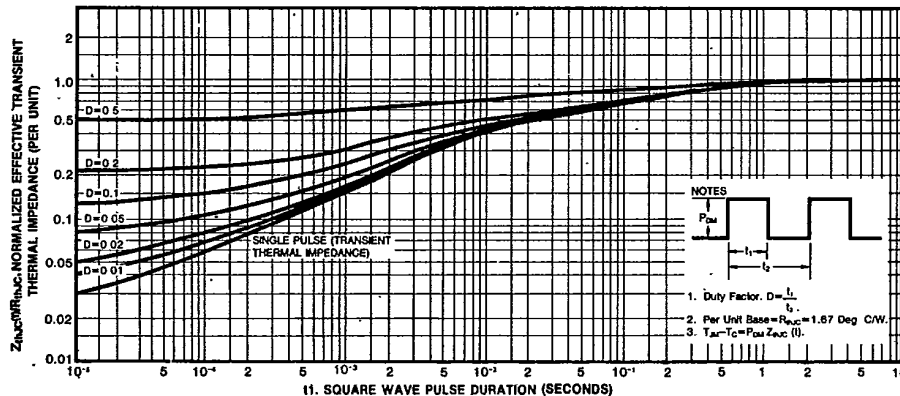

Maximum Effective Transient Thermal Impedance Junction-to-Case Vs. Pulse Duration

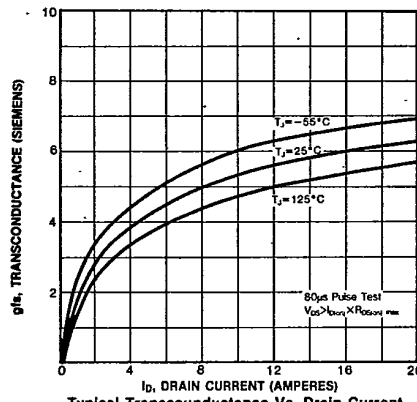

Typical Transconductance Vs. Drain Current

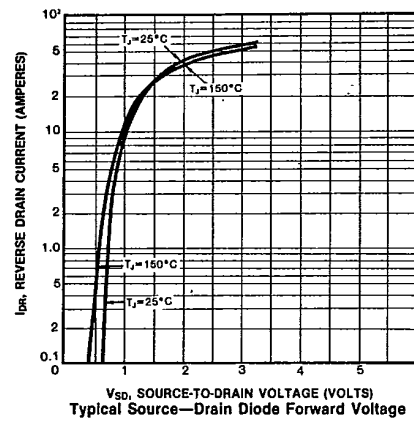

Typical Source-Drain Diode Forward Voltage

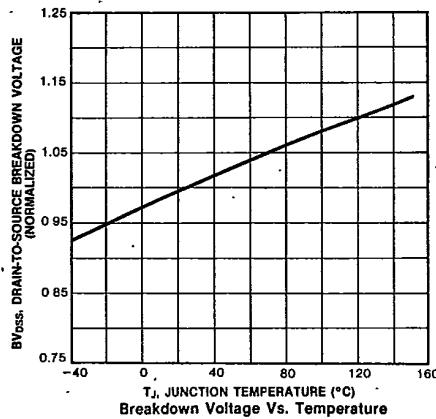

Breakdown Voltage Vs. Temperature

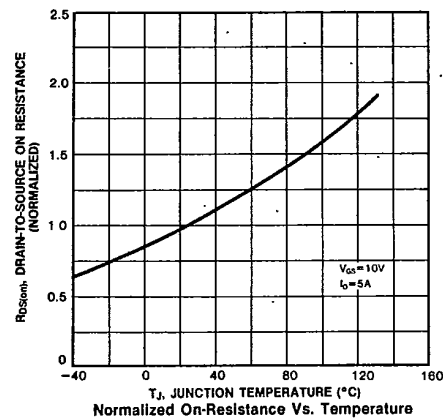

Normalized On-Resistance Vs. Temperature

IRF230/231/232/233

**N-CHANNEL
POWER MOSFETS**

