

FAIRCHILD

A Schlumberger Company

IRF230-233/IRF630-633 *T-39-11*
MTP12N18/12N20 *T-39-13*
N-Channel Power MOSFETs,
12 A, 150-200 V

Power And Discrete Division

Description

These devices are n-channel, enhancement mode, power MOSFETs designed especially for high power, high speed applications, such as switching power supplies, UPS, AC and DC motor controls, relay and solenoid drivers and high energy pulse circuits.

- Low $R_{DS(on)}$
- V_{GS} Rated at ± 20 V
- Silicon Gate for Fast Switching Speeds
- I_{DSS} , $V_{DS(on)}$, Specified at Elevated Temperature
- Rugged
- Low Drive Requirements
- Ease of Paralleling

TO-204AA

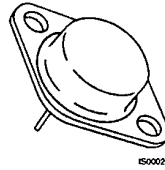

IRF230
 IRF231
 IRF232
 IRF233

TO-220AB

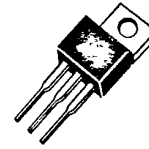

IRF630
 IRF631
 IRF632
 IRF633
 MTP12N18
 MTP12N20

Product Summary

Part Number	V_{DSS}	$R_{DS(on)}$	I_D at $T_C = 25^\circ C$	I_D at $T_C = 100^\circ C$	Case Style
IRF230	200 V	0.40 Ω	9.0 A	6.0 A	TO-204AA
IRF231	150 V	0.40 Ω	9.0 A	6.0 A	
IRF232	200 V	0.50 Ω	8.0 A	5.0 A	
IRF233	150 V	0.50 Ω	8.0 A	5.0 A	
IRF630	200 V	0.40 Ω	9.0 A	6.0 A	TO-220AB
IRF631	150 V	0.40 Ω	9.0 A	6.0 A	
IRF632	200 V	0.50 Ω	8.0 A	5.0 A	
IRF633	150 V	0.50 Ω	8.0 A	5.0 A	
MTP12N18	180 V	0.35 Ω	12 A	8.5 A	
MTP12N20	200 V	0.35 Ω	12 A	8.5 A	

Notes

For information concerning connection diagram and package outline, refer to Section 7.

IRF230-233/IRF630-633
MTP12N18/12N20

T-39-11
 T-39-13

Maximum Ratings

Symbol	Characteristic	Rating IRF220/222 IRF620/622 MTP7N20	Rating MTP7N18	Rating IRF222/223 IRF622/623	Unit
V _{DSS}	Drain to Source Voltage ¹	200	180	150	V
V _{DGR}	Drain to Gate Voltage ¹ R _{GS} = 20 kΩ	200	180	150	V
V _{GS}	Gate to Source Voltage	± 20	± 20	± 20	V
T _J , T _{stg}	Operating Junction and Storage Temperatures	-55 to +150	-55 to +150	-55 to +150	°C
T _L	Maximum Lead Temperature for Soldering Purposes, 1/8" From Case for 5 s	275	275	275	°C

Maximum Thermal Characteristics

		IRF220 - 233 IRF630 - 633	MTP12N18/20	
R _{θJC}	Thermal Resistance, Junction to Case	1.67	1.25	°C/W
P _D	Total Power Dissipation at T _C = 25°C	75	100	W
I _{DM}	Pulsed Drain Current ²	40	40	A

Electrical Characteristics (T_C = 25°C unless otherwise noted)

Symbol	Characteristic	Min	Max	Unit	Test Conditions
Off Characteristics					
V _{(BR)DSS}	Drain Source Breakdown Voltage IRF230/232/630/632/ MTP12N20 MTP12N18 IRF231/233/631/633	200		V	V _{GS} = 0 V, I _D = 250 μA
		180			
		150			
I _{DSS}	Zero Gate Voltage Drain Current		250	μA	V _{DS} = Rated V _{DSS} , V _{GS} = 0 V
			1000	μA	V _{DS} = 0.8 x Rated V _{DSS} , V _{GS} = 0 V, T _C = 125°C
I _{GSS}	Gate-Body Leakage Current IRF230-233 IRF630-633/ MTP12N18/12N20			nA	V _{GS} = ± 20 V, V _{DS} = 0 V
			± 100		
			± 500		

IRF230-233/IRF630-633

MTP12N18/12N20

T-39-11

T-39-13

Electrical Characteristics (Cont.) ($T_C = 25^\circ\text{C}$ unless otherwise noted)

Symbol	Characteristic	Min	Max	Unit	Test Conditions
On Characteristics					
$V_{GS(th)}$	Gate Threshold Voltage			V	$I_D = 250 \mu\text{A}$, $V_{DS} = V_{GS}$ $I_D = 1 \text{ mA}$, $V_{DS} = V_{GS}$
	IRF230/233/630/633	2.0	4.0		
	MTP12N18/12N20	2.0	4.5		
$R_{DS(on)}$	Static Drain-Source On-Resistance ²			Ω	$V_{GS} = 10 \text{ V}$, $I_D = 5.0 \text{ A}$ $I_D = 6.0 \text{ A}$
	IRF230/231/630/631		0.40		
	IRF232/233/632/633		0.50		
	MTP12N18/12N20		0.35		
$V_{DS(on)}$	Drain-Source On-Voltage ²		2.1	V	$V_{GS} = 10 \text{ V}$; $I_D = 6.0 \text{ A}$
	MTP12N18/12N20		5.0	V	$V_{GS} = 10 \text{ V}$; $I_D = 12.0 \text{ A}$;
			4.2	V	$V_{GS} = 10 \text{ V}$; $I_D = 6.0 \text{ A}$ $T_C = 100^\circ\text{C}$
g_{fs}	Forward Transconductance	3.0		S (Ω)	$V_{DS} = 10 \text{ V}$, $I_D = 5.0 \text{ A}$
Dynamic Characteristics					
C_{iss}	Input Capacitance		800	pF	$V_{DS} = 25 \text{ V}$, $V_{GS} = 0 \text{ V}$ $f = 1.0 \text{ MHz}$
C_{oss}	Output Capacitance		450	pF	
C_{rss}	Reverse Transfer Capacitance		150	pF	
Switching Characteristics ($T_C = 25^\circ\text{C}$, Figures 1, 2)¹					
$t_{d(on)}$	Turn-On Delay Time		30	ns	$V_{DD} = 90 \text{ V}$, $I_D = 5.0 \text{ A}$ $V_{GS} = 10 \text{ V}$, $R_{GEN} = 15 \Omega$ $R_{GS} = 15 \Omega$
t_r	Rise Time		50	ns	
$t_{d(off)}$	Turn-Off Delay Time		50	ns	
t_f	Fall Time		40	ns	
$t_{d(on)}$	Turn-On Delay Time		50	ns	$V_{DD} = 25 \text{ V}$, $I_D = 6.0 \text{ A}$ $V_{GS} = 10 \text{ V}$, $R_{GEN} = 50 \Omega$ $R_{GS} = 50 \Omega$
t_r	Rise Time		250	ns	
$t_{d(off)}$	Turn-Off Delay Time		100	ns	
t_f	Fall Time		120	ns	
Q_g	Total Gate Charge		30	nC	$V_{GS} = 10 \text{ V}$, $I_D = 12 \text{ A}$ $V_{DD} = 120 \text{ V}$

IRF230-233/IRF630-633
MTP12N18/12N20

T-39-11

T-39-13

Electrical Characteristics (Cont.) ($T_C = 25^\circ\text{C}$ unless otherwise noted)

Symbol	Characteristic	Typ	Max	Unit	Test Conditions
Source-Drain Diode Characteristics					
V_{SD}	Diode Forward Voltage IRF230/231/630/631	1.25	2.0	V	$I_S = 9.0\text{ A}; V_{GS} = 0\text{ V}$
	IRF232/233/632/633	1.25	1.8	V	$I_S = 8.0\text{ A}; V_{GS} = 0\text{ V}$
t_{rr}	Reverse Recovery Time	450		ns	$I_S = 4.0\text{ A}; I_S/dt = 25\text{ A}/\mu\text{S}$

Notes

- $T_J = +25^\circ\text{C}$ to $+150^\circ\text{C}$
- Pulse width limited by T_J .
- Switching time measurements performed on LEM TR-58 test equipment.

Typical Electrical Characteristics

Figure 1 Switching Test Circuit

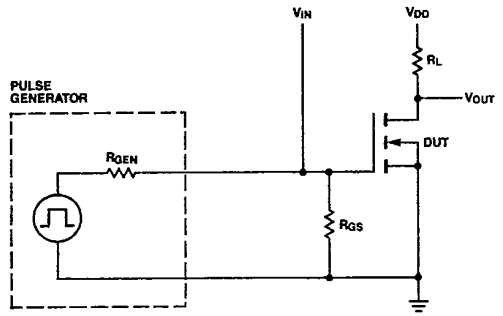

CP04450F

Figure 2 Switching Waveforms

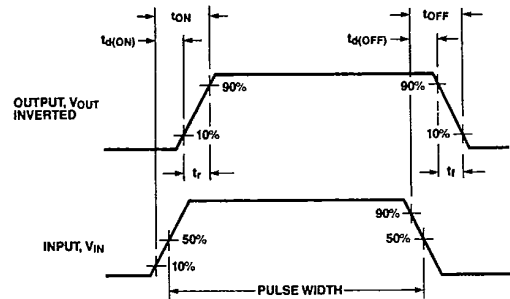

WF00660F

Typical Performance Curves

Figure 3 Output Characteristics

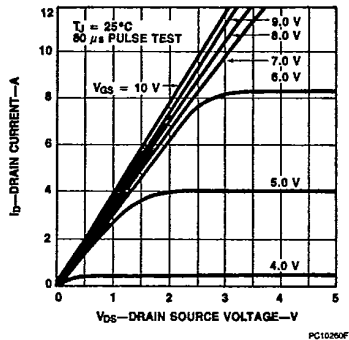

PC10260F

Figure 4 Static Drain to Source Resistance vs Drain Current

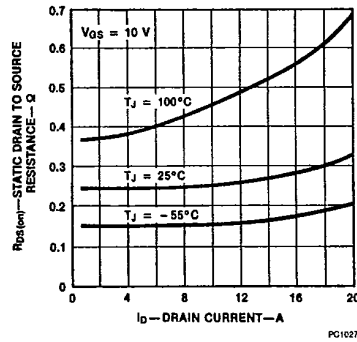

PC10270F

IRF230-233/IRF630-633
MTP12N18/12N20

T-39-11
T-39-13

Typical Performance Curves (Cont.)

Figure 5 Transfer Characteristics

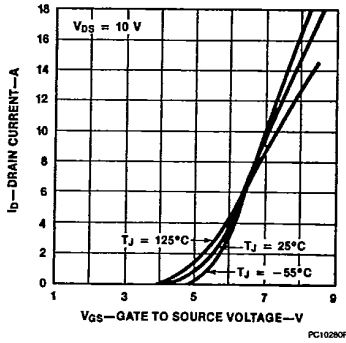

Figure 6 Temperature Variation of Gate to Source Threshold Voltage

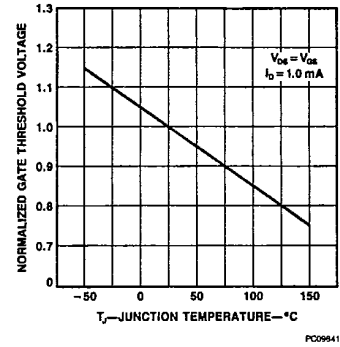

Figure 7 Capacitance vs Drain to Source Voltage

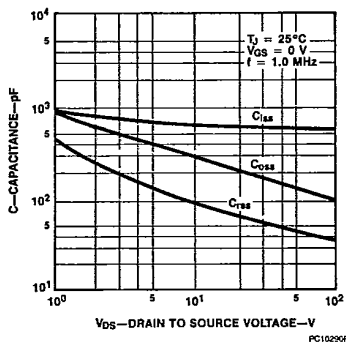

Figure 8 Gate to Source Voltage vs Total Gate Charge

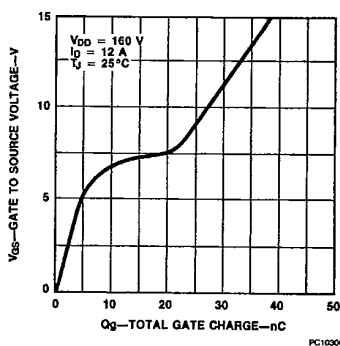

Figure 9 Forward Biased Safe Operating Area for IRF230-233 and IRF630-633

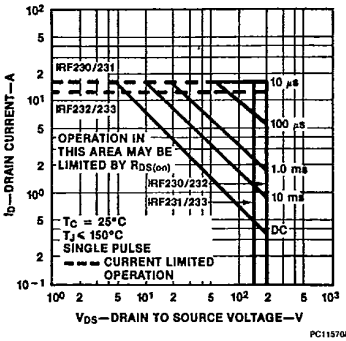
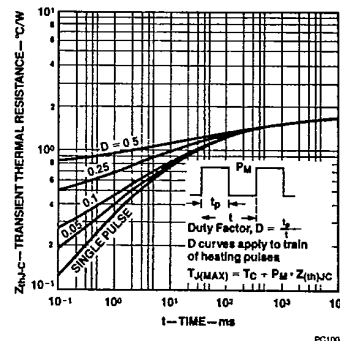

Figure 10 Transient Thermal Resistance vs Time for IRF230-233 and IRF630-633



IRF230-233/IRF630-633
MTP12N18/12N20

T-39-11

T-39-13

Typical Performance Curves (Cont.)

Figure 11 Forward Biased Safe Operating Area for MTP12N18/12N20

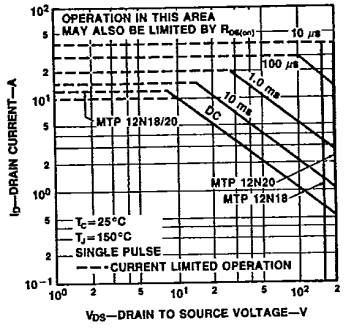

Figure 12 Transient Thermal Resistance vs Time for MTP12N18/12N20

