

OptiMOS™3 Power-Transistor
Features

- N-channel, normal level
- Excellent gate charge x $R_{DS(on)}$ product (FOM)
- Very low on-resistance $R_{DS(on)}$
- 175 °C operating temperature
- Pb-free lead plating; RoHS compliant; halogen free
- Qualified according to JEDEC¹⁾ for target application
- Ideal for high-frequency switching and synchronous rectification

Product Summary

V_{DS}	120	V
$R_{DS(on),max}$	11	mΩ
I_D	75	A

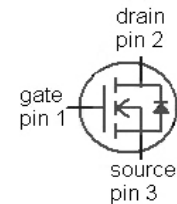

Type	IPS110N12N3 G	IPD110N12N3 G
Package	PG-TO251-3	PG-TO252-3
Marking	110N12N	110N12N

Maximum ratings, at $T_j=25\text{ °C}$, unless otherwise specified

Parameter	Symbol	Conditions	Value	Unit
Continuous drain current	I_D	$T_C=25\text{ °C}$	75	A
		$T_C=100\text{ °C}$	54	
Pulsed drain current ²⁾	$I_{D,pulse}$	$T_C=25\text{ °C}$	300	
Avalanche energy, single pulse	E_{AS}	$I_D=75\text{ A}$, $R_{GS}=25\text{ Ω}$	120	mJ
Gate source voltage ³⁾	V_{GS}		±20	V
Power dissipation	P_{tot}	$T_C=25\text{ °C}$	136	W
Operating and storage temperature	T_j , T_{stg}		-55 ... 175	°C
IEC climatic category; DIN IEC 68-1			55/175/56	

¹⁾J-STD20 and JESD22

²⁾ see figure 3

³⁾ $T_{jmax}=150\text{ °C}$ and duty cycle $D=0.01$ for $V_{gs}<-5\text{ V}$

Parameter	Symbol	Conditions	Values			Unit
			min.	typ.	max.	

Thermal characteristics

Thermal resistance, junction - case	R_{thJC}		-	-	1.1	K/W
Thermal resistance, junction - ambient	R_{thJA}	minimal footprint	-	-	75	
		6 cm ² cooling area ⁴⁾	-	-	50	

Electrical characteristics, at $T_j=25\text{ }^\circ\text{C}$, unless otherwise specified

Static characteristics

Drain-source breakdown voltage	$V_{(BR)DSS}$	$V_{GS}=0\text{ V}, I_D=1\text{ mA}$	120	-	-	V
Gate threshold voltage	$V_{GS(th)}$	$V_{DS}=V_{GS}, I_D=83\text{ }\mu\text{A}$	2	3	4	
Zero gate voltage drain current	I_{DSS}	$V_{DS}=100\text{ V}, V_{GS}=0\text{ V}, T_j=25\text{ }^\circ\text{C}$	-	0.1	1	μA
		$V_{DS}=100\text{ V}, V_{GS}=0\text{ V}, T_j=125\text{ }^\circ\text{C}$	-	10	100	
Gate-source leakage current	I_{GSS}	$V_{GS}=20\text{ V}, V_{DS}=0\text{ V}$	-	1	100	nA
Drain-source on-state resistance	$R_{DS(on)}$	$V_{GS}=10\text{ V}, I_D=75\text{ A}$	-	9.2	11	m Ω
Gate resistance	R_G		-	1.5	-	Ω
Transconductance	g_{fs}	$ V_{DS} >2 I_D R_{DS(on)max}, I_D=75\text{ A}$	42	83	-	S

⁴⁾ Device on 40 mm x 40 mm x 1.5 mm epoxy PCB FR4 with 6 cm² (one layer, 70 μm thick) copper area for drain connection. PCB is vertical in still air.

Parameter	Symbol	Conditions	Values			Unit
			min.	typ.	max.	

Dynamic characteristics

Input capacitance	C_{iss}	$V_{GS}=0\text{ V}, V_{DS}=60\text{ V},$ $f=1\text{ MHz}$	-	3240	4310	pF
Output capacitance	C_{oss}		-	408	543	
Reverse transfer capacitance	C_{rss}		-	22	-	
Turn-on delay time	$t_{d(on)}$	$V_{DD}=60\text{ V}, V_{GS}=10\text{ V},$ $I_D=75\text{ A}, R_G=1.6\ \Omega$	-	16	-	ns
Rise time	t_r		-	16	-	
Turn-off delay time	$t_{d(off)}$		-	24	-	
Fall time	t_f		-	8	-	

Gate Charge Characteristics⁵⁾

Gate to source charge	Q_{gs}	$V_{DD}=60\text{ V}, I_D=75\text{ A},$ $V_{GS}=0\text{ to }10\text{ V}$	-	18	-	nC
Gate to drain charge	Q_{gd}		-	12	-	
Switching charge	Q_{sw}		-	20	-	
Gate charge total	Q_g		-	49	65	
Gate plateau voltage	$V_{plateau}$		-	5.6	-	V
Output charge	Q_{oss}	$V_{DD}=60\text{ V}, V_{GS}=0\text{ V}$	-	56	75	nC

Reverse Diode

Diode continuous forward current	I_S	$T_C=25\text{ }^\circ\text{C}$	-	-	75	A
Diode pulse current	$I_{S,pulse}$		-	-	300	
Diode forward voltage	V_{SD}	$V_{GS}=0\text{ V}, I_F=75\text{ A},$ $T_j=25\text{ }^\circ\text{C}$	-	1	1.2	V
Reverse recovery time	t_{rr}	$V_R=60\text{ V}, I_F=I_S,$ $di_F/dt=100\text{ A}/\mu\text{s}$	-	90	-	ns
Reverse recovery charge	Q_{rr}		-	249	-	nC

⁵⁾ See figure 16 for gate charge parameter definition

1 Power dissipation

$$P_{tot} = f(T_C)$$

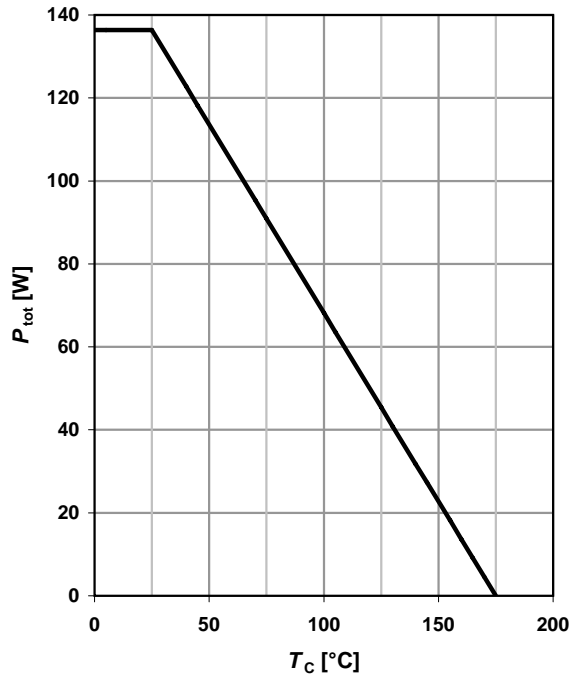

2 Drain current

$$I_D = f(T_C); V_{GS} \geq 10 \text{ V}$$

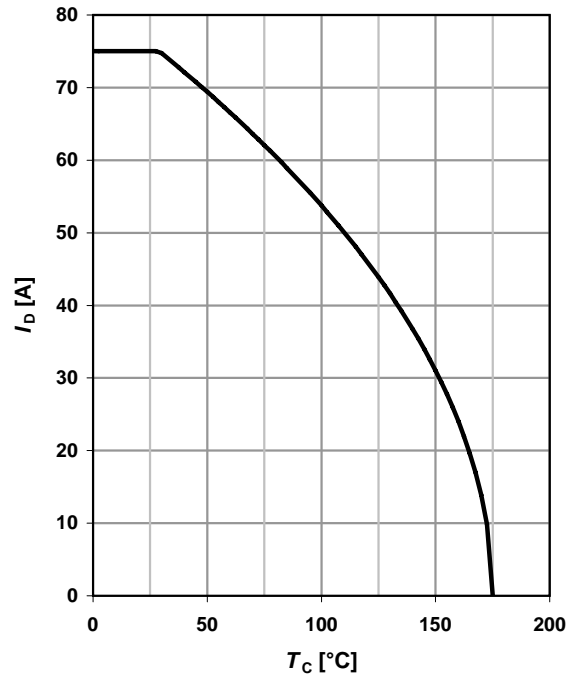

3 Safe operating area

$$I_D = f(V_{DS}); T_C = 25 \text{ °C}; D = 0$$

parameter: t_p

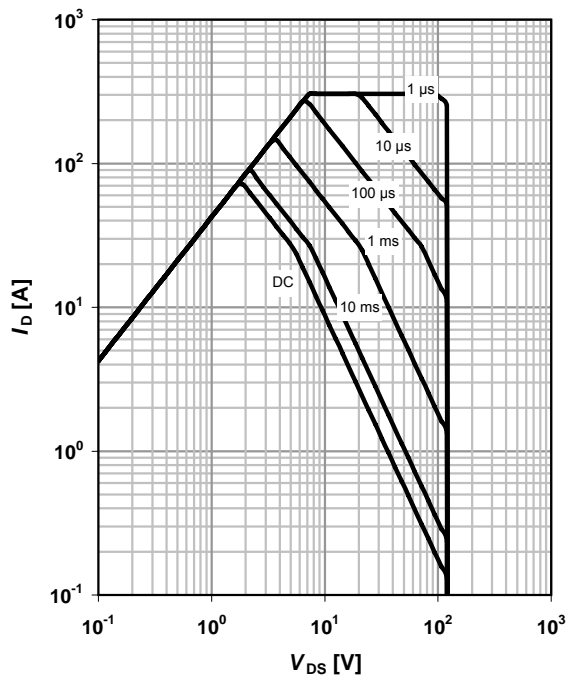

4 Max. transient thermal impedance

$$Z_{thJC} = f(t_p)$$

parameter: $D = t_p / T$

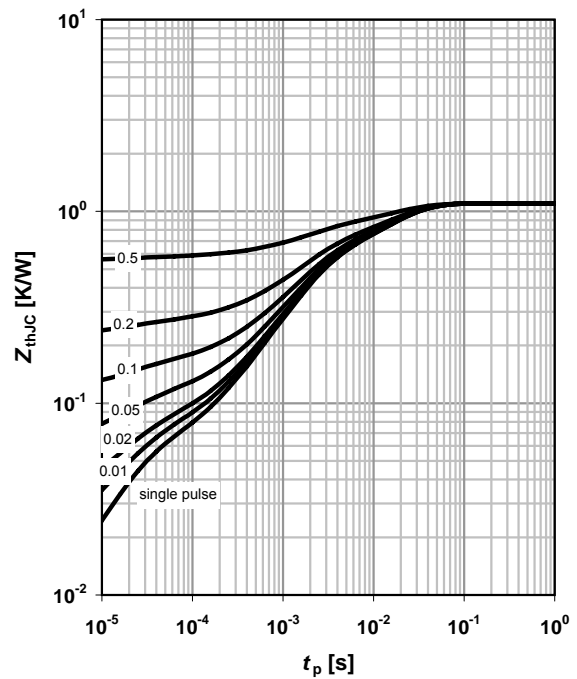

5 Typ. output characteristics

$$I_D = f(V_{DS}); T_j = 25\text{ }^\circ\text{C}$$

parameter: V_{GS}

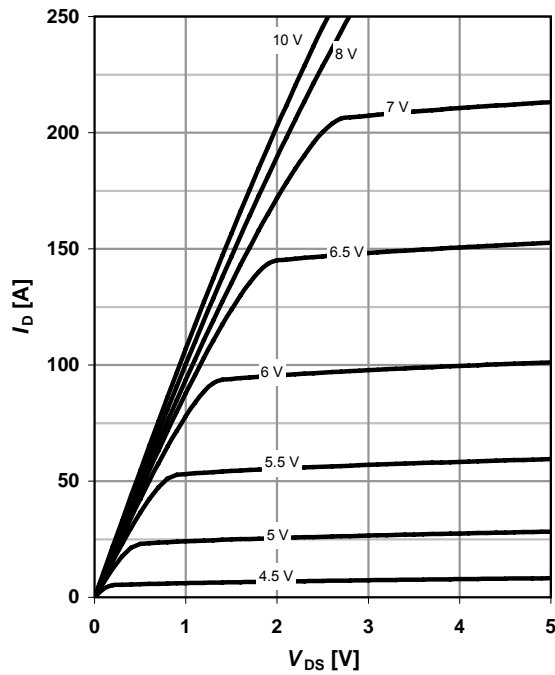

6 Typ. drain-source on resistance

$$R_{DS(on)} = f(I_D); T_j = 25\text{ }^\circ\text{C}$$

parameter: V_{GS}

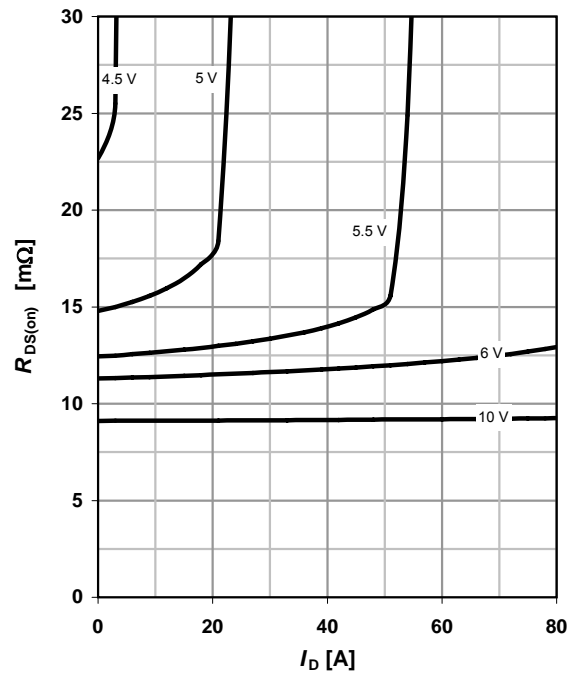

7 Typ. transfer characteristics

$$I_D = f(V_{GS}); |V_{DS}| > 2|I_D|R_{DS(on)max}$$

parameter: T_j

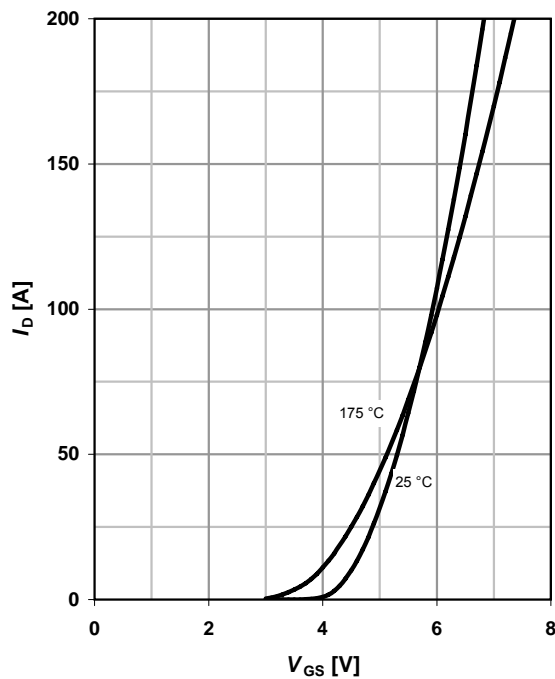

8 Typ. forward transconductance

$$g_{fs} = f(I_D); T_j = 25\text{ }^\circ\text{C}$$

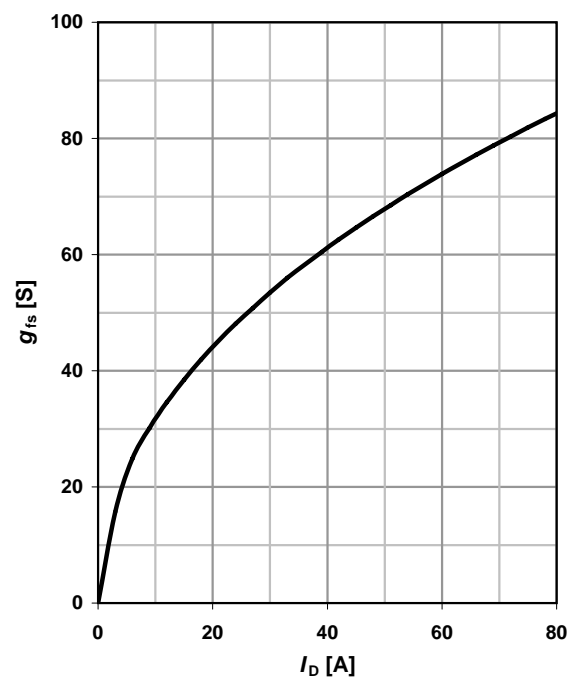

9 Drain-source on-state resistance

$$R_{DS(on)} = f(T_j); I_D = 75 \text{ A}; V_{GS} = 10 \text{ V}$$

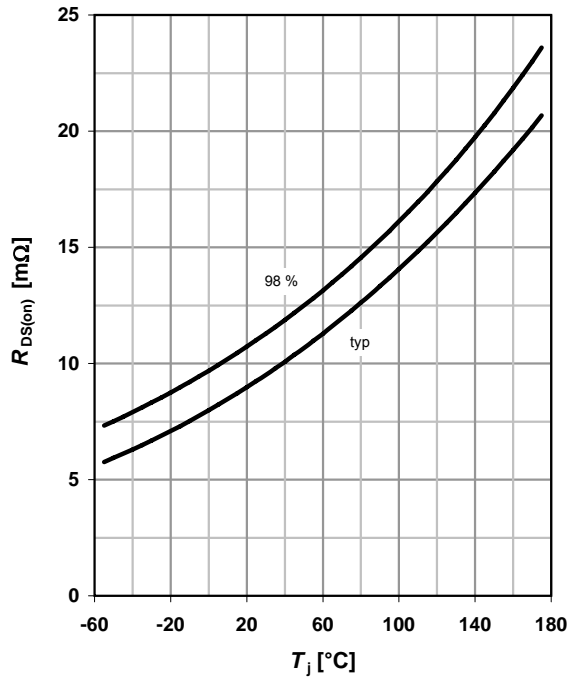

10 Typ. gate threshold voltage

$$V_{GS(th)} = f(T_j); V_{GS} = V_{DS}$$

parameter: I_D

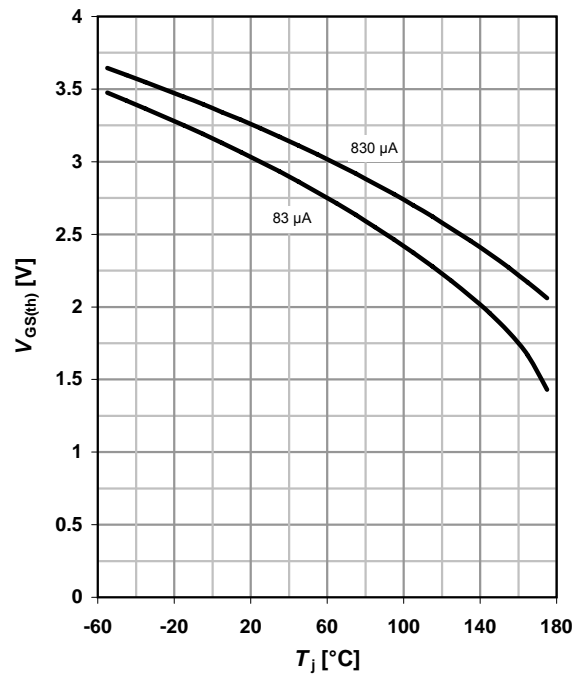

11 Typ. capacitances

$$C = f(V_{DS}); V_{GS} = 0 \text{ V}; f = 1 \text{ MHz}$$

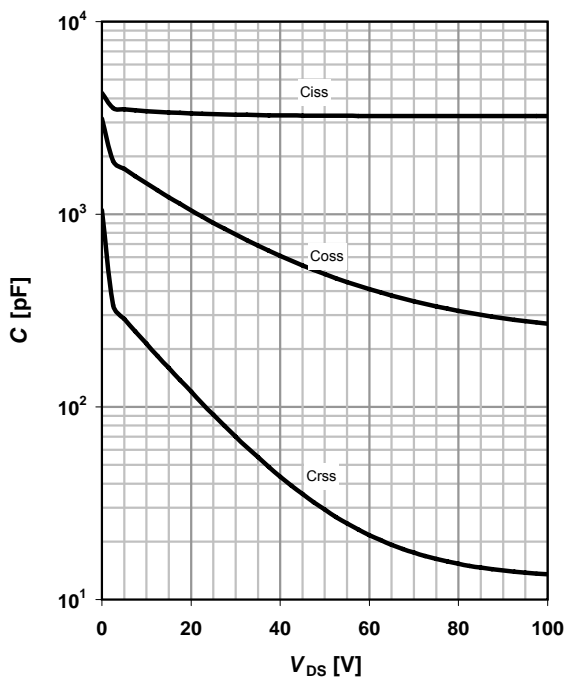

12 Forward characteristics of reverse diode

$$I_F = f(V_{SD})$$

parameter: T_j

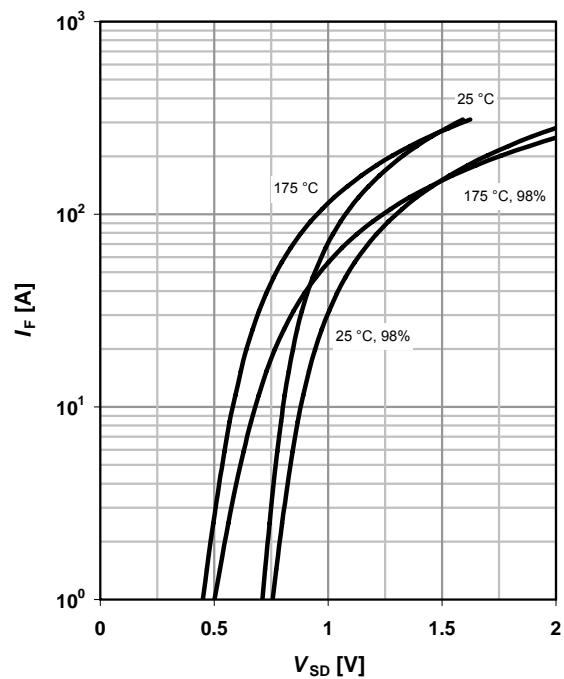

13 Avalanche characteristics

$I_{AS}=f(t_{AV}); R_{GS}=25 \Omega$

parameter: $T_{j(start)}$

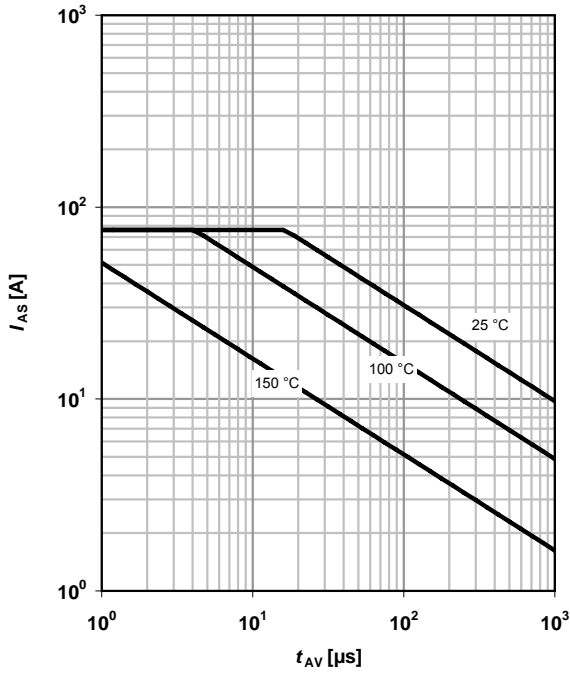

14 Typ. gate charge

$V_{GS}=f(Q_{gate}); I_D=67 \text{ A pulsed}$

parameter: V_{DD}

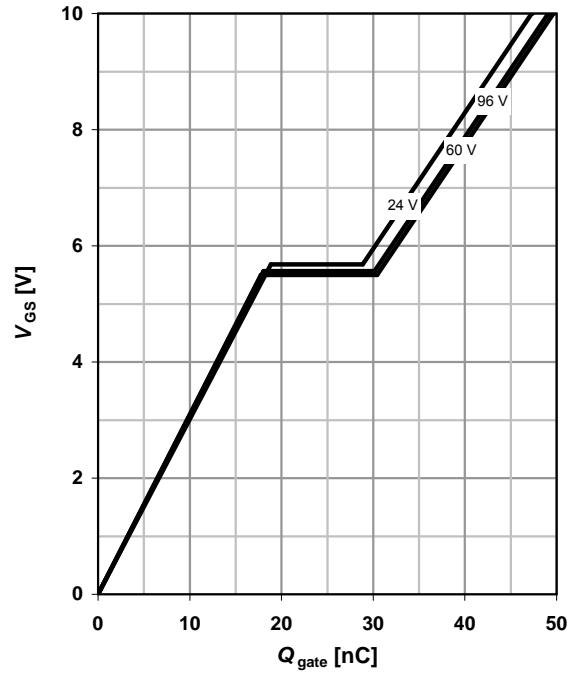

15 Drain-source breakdown voltage

$V_{BR(DSS)}=f(T_j); I_D=1 \text{ mA}$

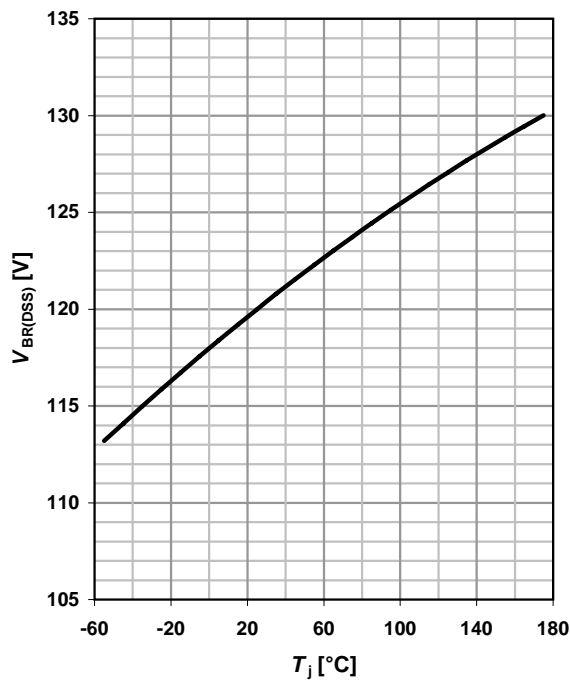

16 Gate charge waveforms

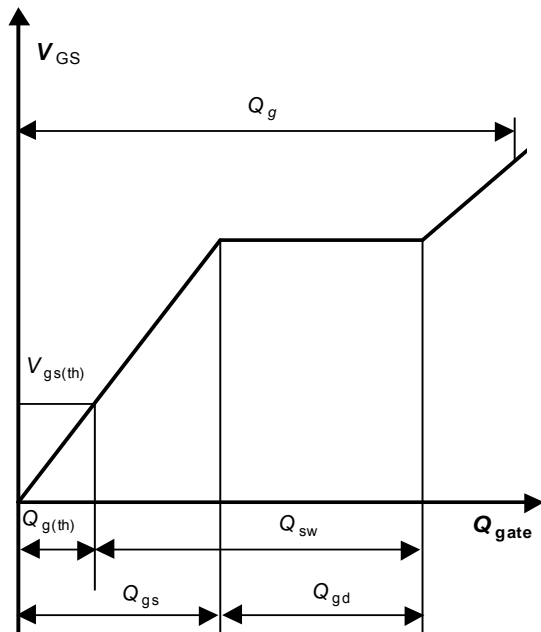

PG-TO-251SL : Outline

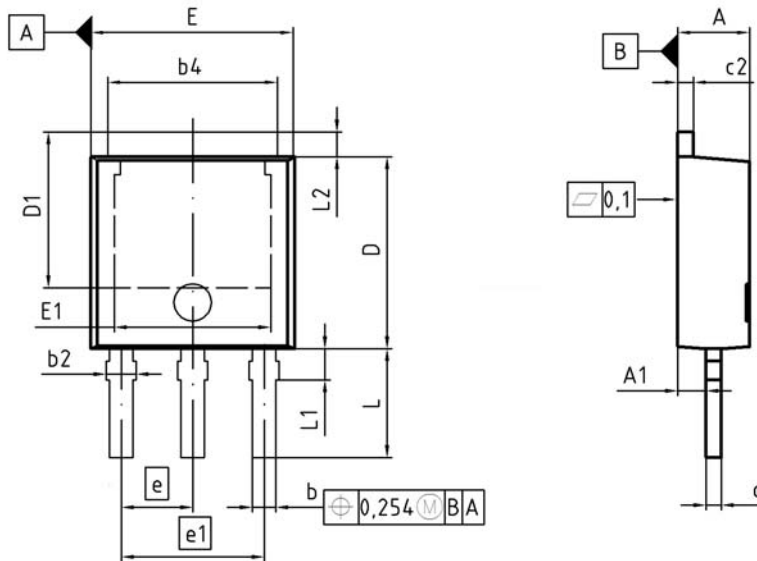

DIM	MILLIMETERS		INCHES	
	MIN	MAX	MIN	MAX
A	2.18	2.39	0.086	0.094
A1	0.80	1.14	0.031	0.045
b	0.64	0.89	0.025	0.035
b2	0.65	1.15	0.026	0.045
b4	4.95	5.50	0.195	0.217
c	0.46	0.58	0.018	0.023
c2	0.46	0.89	0.018	0.035
D	5.97	6.22	0.235	0.245
D1	5.04	5.44	0.198	0.214
E	6.35	6.73	0.250	0.265
E1	4.90	5.10	0.193	0.201
e	2.29		0.090	
e1	4.57		0.180	
N	3		3	
L	3.40	3.60	0.134	0.142
L1	0.90	1.10	0.035	0.043
L2	0.90	1.10	0.035	0.043

DOCUMENT NO.
Z8B00003329

SCALE

EUROPEAN PROJECTION

ISSUE DATE
17-01-2008

REVISION
03

PG-TO252-3: Outline

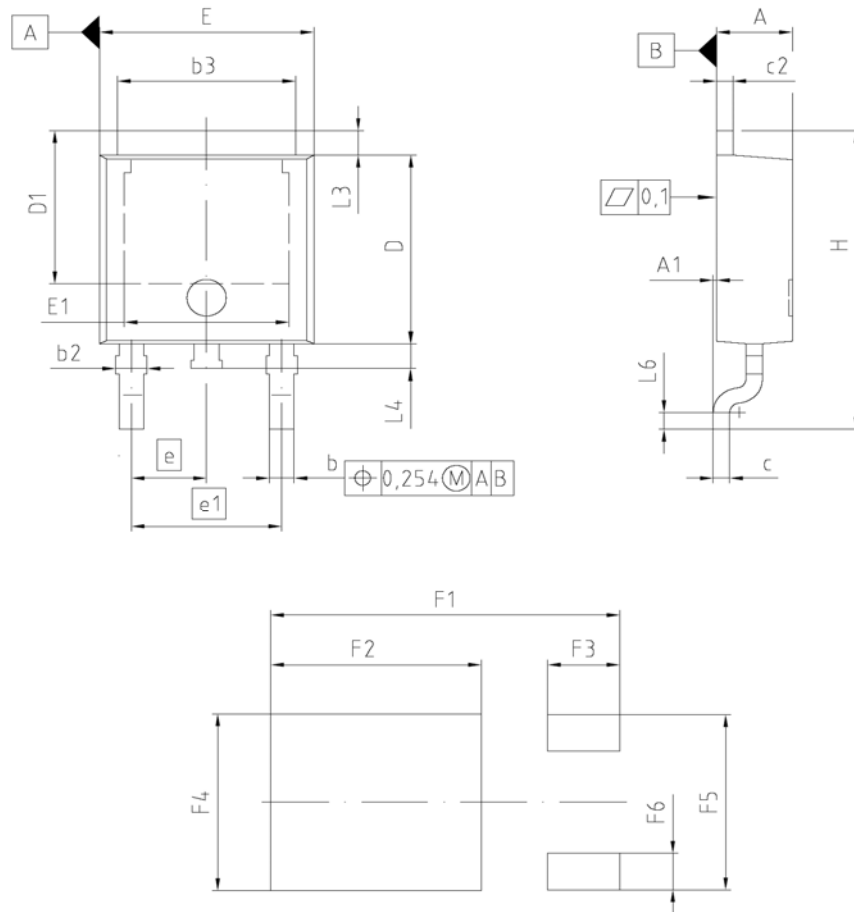

DIM	MILLIMETERS		INCHES	
	MIN	MAX	MIN	MAX
A	2.159	2.413	0.085	0.095
A1	0.000	0.150	0.000	0.006
b	0.635	0.889	0.025	0.035
b2	0.650	1.150	0.026	0.045
b3	5.004	5.500	0.197	0.217
c	0.457	0.580	0.018	0.023
c2	0.460	0.980	0.018	0.039
D	5.969	6.223	0.235	0.245
D1	5.020	5.842	0.198	0.230
E	6.400	6.731	0.252	0.265
E1	4.850	5.207	0.191	0.205
e	2.286		0.090	
e1	4.572		0.180	
N	3		3	
H	9.400	10.480	0.370	0.413
L3	0.900	1.143	0.035	0.045
L4	0.584	0.950	0.023	0.037
L6	0.510	0.686	0.020	0.027
F1	10.500	10.700	0.413	0.421
F2	6.300	6.500	0.248	0.256
F3	2.100	2.300	0.083	0.091
F4	5.700	5.900	0.224	0.232
F5	5.660	5.860	0.222	0.231
F6	1.100	1.300	0.043	0.051

REFERENCE
JEDEC TO252

SCALE
0 2.0 4mm

EUROPEAN PROJECTION

ISSUE DATE
21-09-2005

FILE
TO252_1

Published by**Infineon Technologies AG****81726 Munich, Germany****© 2009 Infineon Technologies AG****All Rights Reserved.****Legal Disclaimer**

The information given in this document shall in no event be regarded as a guarantee of conditions or characteristics. With respect to any examples or hints given herein, any typical values stated herein and/or any information regarding the application of the device, Infineon Technologies hereby disclaims any and all warranties and liabilities of any kind, including without limitation, warranties of non-infringement of intellectual property rights of any third party.

Information

For further information on technology, delivery terms and conditions and prices, please contact the nearest Infineon Technologies Office (www.infineon.com).

Warnings

Due to technical requirements, components may contain dangerous substances. For information on the types in question, please contact the nearest Infineon Technologies Office.

Infineon Technologies components may be used in life-support devices or systems only with the express written approval of Infineon Technologies, if a failure of such components can reasonably be expected to cause the failure of that life-support device or system or to affect the safety or effectiveness of that device or system. Life support devices or systems are intended to be implanted in the human body or to support and/or maintain and sustain and/or protect human life. If they fail, it is reasonable to assume that the health of the user or other persons may be endangered.