

**IN74HCT573A**

**Octal 3-State Noninverting  
Transparent Latch  
High-Performance Silicon-Gate CMOS**

The IN74HCT573A is identical in pinout to the LS/ALS573. This device may be used as a level converter for interfacing TTL or NMOS outputs to High-Speed CMOS inputs.

These latches appear transparent to data (i.e., the outputs change asynchronously) when Latch Enable is high. When Latch Enable goes low, data meeting the setup and hold time becomes latched.

The Output Enable input does not affect the state of the latches, but when Output Enable is high, all device outputs are forced to the high-impedance state. Thus, data may be latched even when the outputs are not enabled.

- TTL/NMOS-Compatible Input Levels
- Outputs Directly Interface to CMOS, NMOS, and TTL
- Operating Voltage Range: 4.5 to 5.5 V
- Low Input Current: 1.0  $\mu$ A

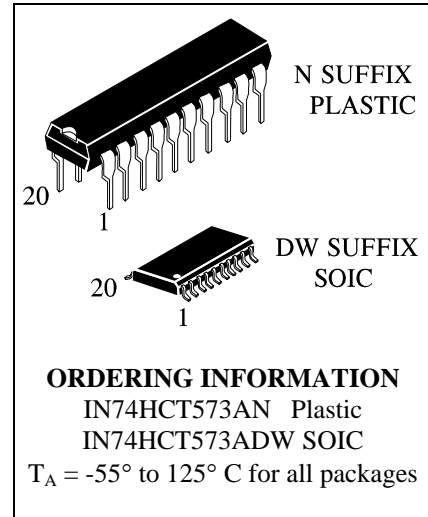

**LOGIC DIAGRAM**

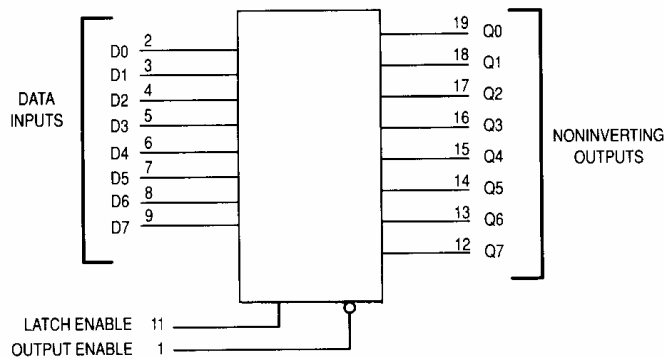

PIN 20 =  $V_{CC}$   
 PIN 10 = GND

**PIN ASSIGNMENT**

OUTPUT ENABLE	1	20	$V_{CC}$
D0	2	19	Q0
D1	3	18	Q1
D2	4	17	Q2
D3	5	16	Q3
D4	6	15	Q4
D5	7	14	Q5
D6	8	13	Q6
D7	9	12	Q7
GND	10	11	LATCH ENABLE

**FUNCTION TABLE**

Inputs			Output
Output Enable	Latch Enable	D	Q
L	H	H	H
L	H	L	L
L	L	X	no change
H	X	X	Z

X = don't care  
 Z = high impedance

**MAXIMUM RATINGS\***

Symbol	Parameter	Value	Unit
V <sub>CC</sub>	DC Supply Voltage (Referenced to GND)	-0.5 to +7.0	V
V <sub>IN</sub>	DC Input Voltage (Referenced to GND)	-1.5 to V <sub>CC</sub> +1.5	V
V <sub>OUT</sub>	DC Output Voltage (Referenced to GND)	-0.5 to V <sub>CC</sub> +0.5	V
I <sub>IN</sub>	DC Input Current, per Pin	±20	mA
I <sub>OUT</sub>	DC Output Current, per Pin	±35	mA
I <sub>CC</sub>	DC Supply Current, V <sub>CC</sub> and GND Pins	±75	mA
P <sub>D</sub>	Power Dissipation in Still Air, Plastic DIP+ SOIC Package+	750 500	mW
T <sub>stg</sub>	Storage Temperature	-65 to +150	°C
T <sub>L</sub>	Lead Temperature, 1 mm from Case for 10 Seconds (Plastic DIP or SOIC Package)	260	°C

\*Maximum Ratings are those values beyond which damage to the device may occur. Functional operation should be restricted to the Recommended Operating Conditions.

+Derating - Plastic DIP: - 10 mW/°C from 65° to 125°C  
SOIC Package: : - 7 mW/°C from 65° to 125°C

**RECOMMENDED OPERATING CONDITIONS**

Symbol	Parameter	Min	Max	Unit
V <sub>CC</sub>	DC Supply Voltage (Referenced to GND)	4.5	5.5	V
V <sub>IN</sub> , V <sub>OUT</sub>	DC Input Voltage, Output Voltage (Referenced to GND)	0	V <sub>CC</sub>	V
T <sub>A</sub>	Operating Temperature, All Package Types	-55	+125	°C
t <sub>r</sub> , t <sub>f</sub>	Input Rise and Fall Time (Figure 1)	0	500	ns

This device contains protection circuitry to guard against damage due to high static voltages or electric fields. However, precautions must be taken to avoid applications of any voltage higher than maximum rated voltages to this high-impedance circuit. For proper operation, V<sub>IN</sub> and V<sub>OUT</sub> should be constrained to the range GND ≤ (V<sub>IN</sub> or V<sub>OUT</sub>) ≤ V<sub>CC</sub>.

Unused inputs must always be tied to an appropriate logic voltage level (e.g., either GND or V<sub>CC</sub>). Unused outputs must be left open.

**DC ELECTRICAL CHARACTERISTICS** (Voltages Referenced to GND)

Symbol	Parameter	Test Conditions	V <sub>CC</sub> V	Guaranteed Limit			Unit
				25 °C to -55°C	≤85 °C	≤125 °C	
V <sub>IH</sub>	Minimum High-Level Input Voltage	V <sub>OUT</sub> =0.1 V or V <sub>CC</sub> -0.1 V  I <sub>OUT</sub>   ≤ 20 μA	4.5	2.0	2.0	2.0	V
			5.5	2.0	2.0	2.0	
V <sub>IL</sub>	Maximum Low - Level Input Voltage	V <sub>OUT</sub> =0.1 V or V <sub>CC</sub> -0.1 V  I <sub>OUT</sub>   ≤ 20 μA	4.5	0.8	0.8	0.8	V
			5.5	0.8	0.8	0.8	
V <sub>OH</sub>	Minimum High-Level Output Voltage	V <sub>IN</sub> =V <sub>IH</sub> or V <sub>IL</sub>  I <sub>OUT</sub>   ≤ 20 μA	4.5	4.4	4.4	4.4	V
		5.5	5.4	5.4	5.4		
V <sub>OL</sub>	Maximum Low-Level Output Voltage	V <sub>IN</sub> =V <sub>IH</sub> or V <sub>IL</sub>  I <sub>OUT</sub>   ≤ 6.0 mA	4.5	3.98	3.84	3.7	V
		5.5	0.1	0.1	0.1		
I <sub>IN</sub>	Maximum Input Leakage Current	V <sub>IN</sub> =V <sub>IL</sub> or V <sub>IH</sub>  I <sub>OUT</sub>   ≤ 20 μA	4.5	0.1	0.1	0.1	V
		5.5	0.1	0.1	0.1		
I <sub>IN</sub>	Maximum Input Leakage Current	V <sub>IN</sub> =V <sub>CC</sub> or GND	5.5	±0.1	±1.0	±1.0	μA
		5.5	±0.1	±1.0	±1.0		
I <sub>OZ</sub>	Maximum Three State Leakage Current	Output in High-Impedance State V <sub>IN</sub> =V <sub>IH</sub> or V <sub>IL</sub> V <sub>OUT</sub> =V <sub>CC</sub> or GND	5.5	±0.5	±5.0	±10	μA
I <sub>CC</sub>	Maximum Quiescent Supply Current (per Package)	V <sub>IN</sub> =V <sub>CC</sub> or GND I <sub>OUT</sub> =0μA	5.5	4.0	40	160	μA
ΔI <sub>CC</sub>	Additional Quiescent Supply Current	V <sub>IN</sub> =2.4 V, Any One Input V <sub>IN</sub> =V <sub>CC</sub> or GND, Other Inputs I <sub>OUT</sub> =0μA	5.5	≥-55°C	25°C to 125°C		mA
				2.9	2.4		

**AC ELECTRICAL CHARACTERISTICS** ( $V_{CC} = 5.0 \text{ V} \pm 10\%$ ,  $C_L = 50\text{pF}$ , Input  $t_r = t_f = 6.0 \text{ ns}$ )

Symbol	Parameter	Guaranteed Limit			Unit
		25 °C to -55°C	≤85°C	≤125°C	
$t_{PLH}, t_{PHL}$	Maximum Propagation Delay, Input D to Q (Figures 1 and 5)	30	38	45	ns
$t_{PLH}, t_{PHL}$	Maximum Propagation Delay, Latch Enable to Q (Figures 2 and 5)	30	38	45	ns
$t_{PLZ}, t_{PHZ}$	Maximum Propagation Delay, Output Enable to Q (Figures 3 and 6)	28	35	42	ns
$t_{PZH}, t_{PZL}$	Maximum Propagation Delay, Output Enable to Q (Figures 3 and 6)	28	35	42	ns
$t_{TLH}, t_{THL}$	Maximum Output Transition Time, Any Output (Figures 1 and 5)	12	15	18	ns
$C_{IN}$	Maximum Input Capacitance	10	10	10	pF
$C_{OUT}$	Maximum Three-State Output Capacitance (Output in High-Impedance State)	15	15	15	pF

$C_{PD}$	Power Dissipation Capacitance (Per Enabled Output)	Typical @ 25°C, $V_{CC} = 5.0 \text{ V}$			pF
	Used to determine the no-load dynamic power consumption: $P_D = C_{PD} V_{CC}^2 f + I_{CC} V_{CC}$	48			

**TIMING REQUIREMENTS** ( $V_{CC} = 5.0 \text{ V} \pm 10\%$ ,  $C_L = 50\text{pF}$ , Input  $t_r = t_f = 6.0 \text{ ns}$ )

Symbol	Parameter	Guaranteed Limit			Unit
		25 °C to -55°C	≤85°C	≤125°C	
$t_{SU}$	Minimum Setup Time, Input D to Latch Enable (Figure 4)	10	13	15	ns
$t_H$	Minimum Hold Time, Latch Enable to Input D (Figure 4)	5	5	5	ns
$t_W$	Minimum Pulse Width, Latch Enable (Figure 2)	15	19	22	ns
$t_r, t_f$	Maximum Input Rise and Fall Times (Figure 1)	500	500	500	ns

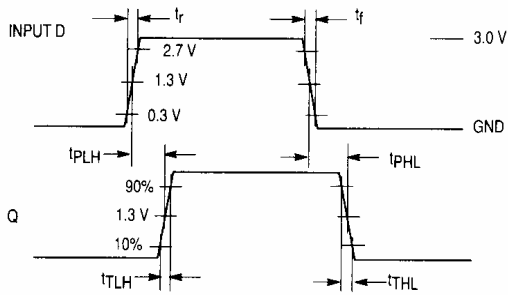

Figure 1. Switching Waveforms

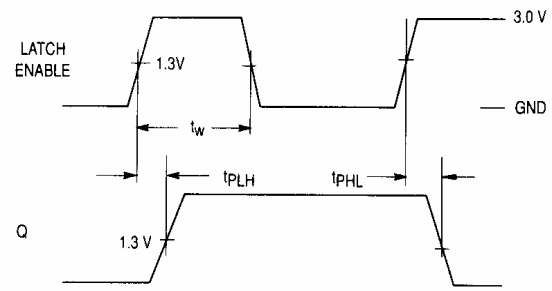

Figure 2. Switching Waveforms

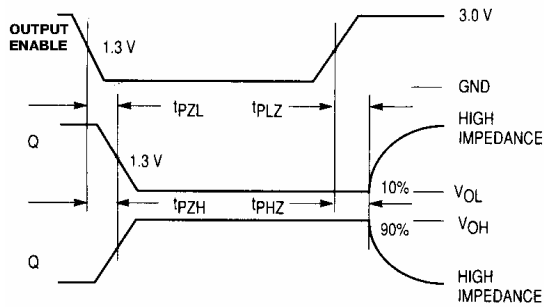

Figure 3. Switching Waveforms

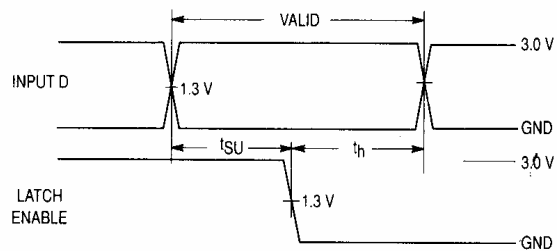
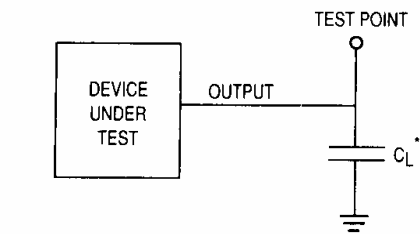
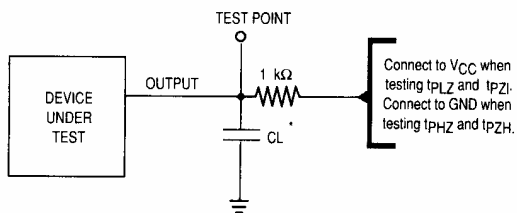

Figure 4. Switching Waveforms



\* Includes all probe and jig capacitance

Figure 5. Test Circuit



\* Includes all probe and jig capacitance

Figure 6. Test Circuit

EXPANDED LOGIC DIAGRAM

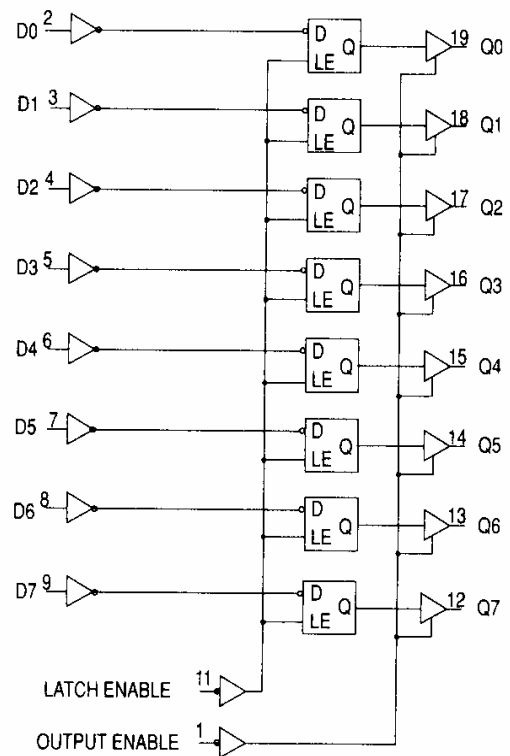

**N SUFFIX PLASTIC DIP**  
(MS - 001AD)

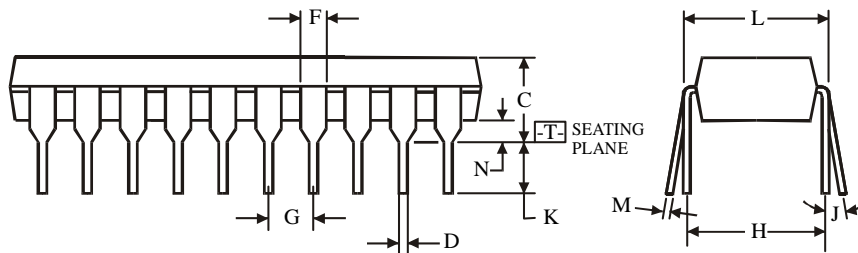
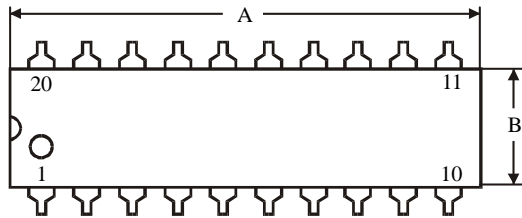
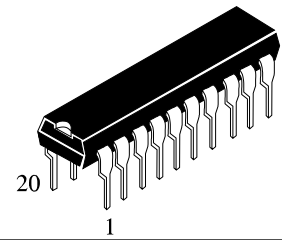

$\oplus 0.25 (0.010) \text{M} \text{ T}$

**NOTES:**

- Dimensions "A", "B" do not include mold flash or protrusions.  
Maximum mold flash or protrusions 0.25 mm (0.010) per side.

Symbol	Dimension, mm	
	MIN	MAX
A	24.89	26.92
B	6.1	7.11
C		5.33
D	0.36	0.56
F	1.14	1.78
G	2.54	
H	7.62	
J	0°	10°
K	2.92	3.81
L	7.62	8.26
M	0.2	0.36
N	0.38	

**D SUFFIX SOIC**  
(MS - 013AC)

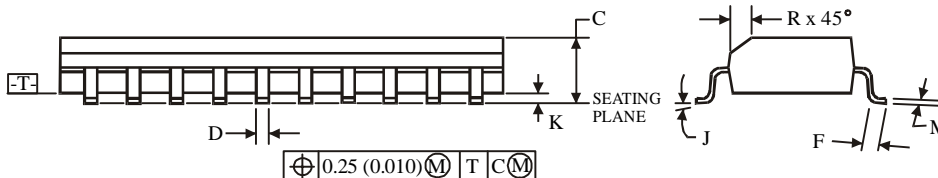
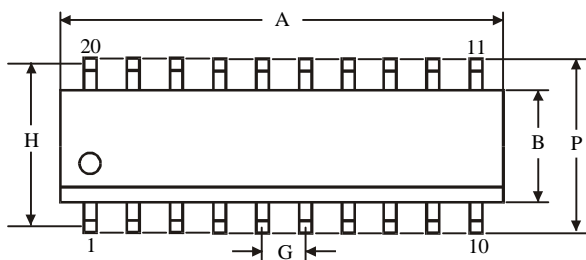
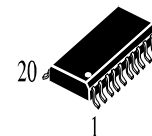

$\oplus 0.25 (0.010) \text{M} \text{ T} \text{ C} \text{ M}$

**NOTES:**

- Dimensions A and B do not include mold flash or protrusion.
- Maximum mold flash or protrusion 0.15 mm (0.006) per side  
for A; for B - 0.25 mm (0.010) per side.

Symbol	Dimension, mm	
	MIN	MAX
A	12.6	13
B	7.4	7.6
C	2.35	2.65
D	0.33	0.51
F	0.4	1.27
G	1.27	
H	9.53	
J	0°	8°
K	0.1	0.3
M	0.23	0.32
P	10	10.65
R	0.25	0.75