

**IN74HCT08A**

**Quad 2-Input AND Gate**  
**High-Performance Silicon-Gate CMOS**

The IN74HCT08A may be used as a level converter for intertacing TTL or NMOS outputs to high-speed CMOS inputs.

The IN74HCT08A is identical in pinout to the LS/ALS08.

- TTL/NMOS-Compatible Input Levels.
- Outputs Directly Interface to CMOS, NMOS, and TTL
- Operating Voltage Range: 4.5 to 5.5 V
- Low Input Current: 1.0  $\mu$ A

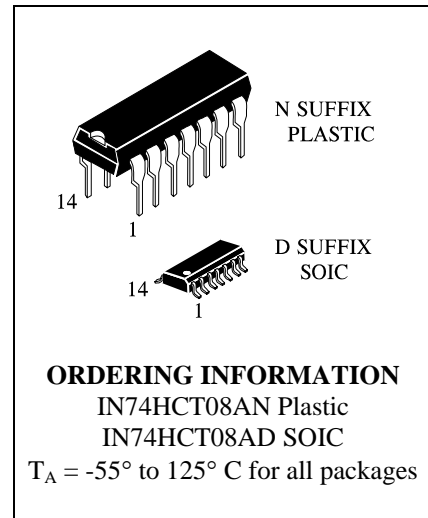

**LOGIC DIAGRAM**

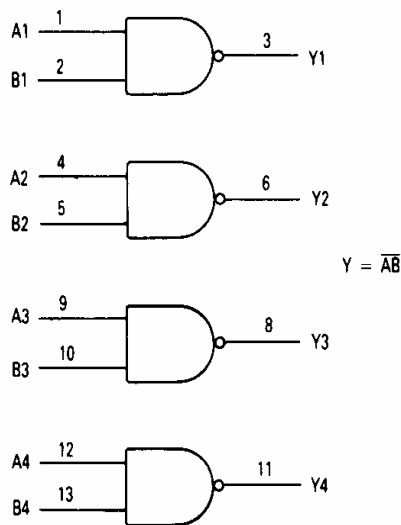

PIN 14 =  $V_{CC}$   
 PIN 7 = GND

**PIN ASSIGNMENT**

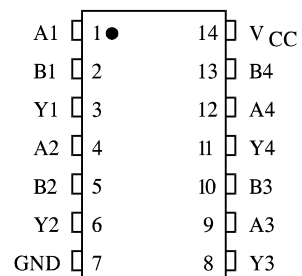

**FUNCTION TABLE**

| Inputs |   | Output |
|--------|---|--------|
| A      | B | Y      |
| L      | L | L      |
| L      | H | L      |
| H      | L | L      |
| H      | H | H      |

**MAXIMUM RATINGS\***

| Symbol           | Parameter  | Value                        | Unit |
|------------------|--|------------------------------|------|
| V <sub>CC</sub>  | DC Supply Voltage (Referenced to GND)  | -0.5 to +7.0                 | V    |
| V <sub>IN</sub>  | DC Input Voltage (Referenced to GND)   | -1.5 to V <sub>CC</sub> +1.5 | V    |
| V <sub>OUT</sub> | DC Output Voltage (Referenced to GND)  | -0.5 to V <sub>CC</sub> +0.5 | V    |
| I <sub>IN</sub>  | DC Input Current, per Pin  | ±20                          | mA   |
| I <sub>OUT</sub> | DC Output Current, per Pin   | ±25                          | mA   |
| I <sub>CC</sub>  | DC Supply Current, V <sub>CC</sub> and GND Pins                                  | ±50                          | mA   |
| P <sub>D</sub>   | Power Dissipation in Still Air, Plastic DIP+<br>SOIC Package+                    | 750<br>500                   | mW   |
| T <sub>stg</sub> | Storage Temperature  | -65 to +150                  | °C   |
| T <sub>L</sub>   | Lead Temperature, 1 mm from Case for 10 Seconds<br>(Plastic DIP or SOIC Package) | 260                          | °C   |

\*Maximum Ratings are those values beyond which damage to the device may occur. Functional operation should be restricted to the Recommended Operating Conditions.

+Derating - Plastic DIP: - 10 mW/°C from 65° to 125°C

SOIC Package: : - 7 mW/°C from 65° to 125°C

**RECOMMENDED OPERATING CONDITIONS**

| Symbol                             | Parameter  | Min | Max             | Unit |
|------------------------------------|--|-----|-----------------|------|
| V <sub>CC</sub>                    | DC Supply Voltage (Referenced to GND)                | 4.5 | 5.5             | V    |
| V <sub>IN</sub> , V <sub>OUT</sub> | DC Input Voltage, Output Voltage (Referenced to GND) | 0   | V <sub>CC</sub> | V    |
| T <sub>A</sub>                     | Operating Temperature, All Package Types             | -55 | +125            | °C   |
| t <sub>r</sub> , t <sub>f</sub>    | Input Rise and Fall Time (Figure 1)                  | 0   | 500             | ns   |

This device contains protection circuitry to guard against damage due to high static voltages or electric fields. However, precautions must be taken to avoid applications of any voltage higher than maximum rated voltages to this high-impedance circuit. For proper operation, V<sub>IN</sub> and V<sub>OUT</sub> should be constrained to the range GND ≤ (V<sub>IN</sub> or V<sub>OUT</sub>) ≤ V<sub>CC</sub>.

Unused inputs must always be tied to an appropriate logic voltage level (e.g., either GND or V<sub>CC</sub>). Unused outputs must be left open.

**DC ELECTRICAL CHARACTERISTICS** (Voltages Referenced to GND)

| Symbol           | Parameter                                      | Test Conditions   | V <sub>CC</sub><br>V | Guaranteed Limit     |                  |            | Unit |
|------------------|--|---|----------------------|----------------------|------------------|------------|------|
|                  |  |   |                      | 25 °C<br>to<br>-55°C | ≤85<br>°C        | ≤125<br>°C |      |
| V <sub>IH</sub>  | Minimum High-Level Input Voltage               | V <sub>OUT</sub> =0.1 V or V <sub>CC</sub> -0.1 V<br>  I <sub>OUT</sub>   ≤ 20 μA   | 4.5                  | 2.0                  | 2.0              | 2.0        | V    |
|                  |  |   | 5.5                  | 2.0                  | 2.0              | 2.0        |      |
| V <sub>IL</sub>  | Maximum Low - Level Input Voltage              | V <sub>OUT</sub> =0.1 V<br>  I <sub>OUT</sub>   ≤ 20 μA   | 4.5                  | 0.8                  | 0.8              | 0.8        | V    |
|                  |  |   | 5.5                  | 0.8                  | 0.8              | 0.8        |      |
| V <sub>OH</sub>  | Minimum High-Level Output Voltage              | V <sub>IN</sub> =V <sub>IH</sub><br>  I <sub>OUT</sub>   ≤ 20 μA  | 4.5                  | 4.4                  | 4.4              | 4.4        | V    |
|                  |  | V <sub>IN</sub> =V <sub>IH</sub><br>  I <sub>OUT</sub>   ≤ 4.0 mA   | 5.5                  | 5.4                  | 5.4              | 5.4        |      |
| V <sub>OL</sub>  | Maximum Low-Level Output Voltage               | V <sub>IN</sub> =V <sub>IH</sub> or V <sub>IL</sub><br>  I <sub>OUT</sub>   ≤ 20 μA   | 4.5                  | 0.1                  | 0.1              | 0.1        | V    |
|                  |  | V <sub>IN</sub> =V <sub>IH</sub> or V <sub>IL</sub><br>  I <sub>OUT</sub>   ≤ 4.0 mA  | 5.5                  | 0.1                  | 0.1              | 0.1        |      |
| I <sub>IN</sub>  | Maximum Input Leakage Current                  | V <sub>IN</sub> =V <sub>CC</sub> or GND   | 5.5                  | ±0.1                 | ±1.0             | ±1.0       | μA   |
| I <sub>CC</sub>  | Maximum Quiescent Supply Current (per Package) | V <sub>IN</sub> =V <sub>CC</sub> or GND<br>I <sub>OUT</sub> =0μA  | 5.5                  | 1.0                  | 10               | 40         | μA   |
| ΔI <sub>CC</sub> | Additional Quiescent Supply Current            | V <sub>IN</sub> = 2.4 V, Any One Input<br>V <sub>IN</sub> =V <sub>CC</sub> or GND, Other<br>Inputs<br>I <sub>OUT</sub> =0μA | 5.5                  | ≥-55°C               | 25°C to<br>125°C |            | mA   |
|                  |  |   |                      | 2.9                  | 2.4              |            |      |

**AC ELECTRICAL CHARACTERISTICS** ( $V_{CC}=5.0\text{ V} \pm 10\%$ ,  $C_L=50\text{pF}$ , Input  $t_r=t_f=6.0\text{ ns}$ )

| Symbol             | Parameter   | Guaranteed Limits |       |        | Unit |
|--------------------|---|-------------------|-------|--------|------|
|                    |   | 25 °C to -55°C    | ≤85°C | ≤125°C |      |
| $t_{PLH}, t_{PHL}$ | Maximum Propagation Delay, Input A or B to Output Y (Figures 1 and 2) | 19                | 24    | 28     | ns   |
| $t_{TLH}, t_{THL}$ | Maximum Output Transition Time, Any Output (Figures 1 and 2)          | 15                | 19    | 22     | ns   |
| $C_{IN}$           | Maximum Input Capacitance   | 10                | 10    | 10     | pF   |

|          |  |                                       |  |  |    |
|----------|--|---------------------------------------|--|--|----|
| $C_{PD}$ | Power Dissipation Capacitance (Per Gate)   | Typical @ 25°C, $V_{CC}=5.0\text{ V}$ |  |  | pF |
|          | Used to determine the no-load dynamic power consumption:<br>$P_D=C_{PD}V_{CC}^2f+I_{CC}V_{CC}$ | 20                                    |  |  |    |

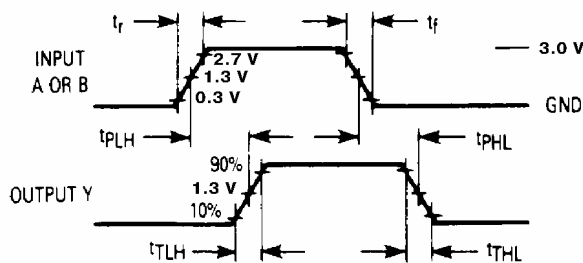
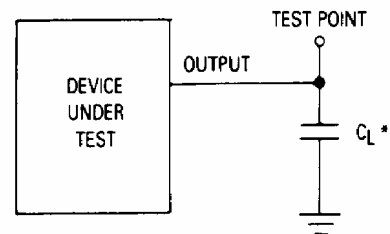

Figure 1. Switching Waveforms.



\*Includes all probe and jig capacitance.

Figure 2. Test Circuit

**EXPANDED LOGIC DIAGRAM**  
(1/4 of the Device)

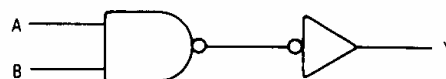

**N SUFFIX PLASTIC DIP  
(MS - 001AA)**

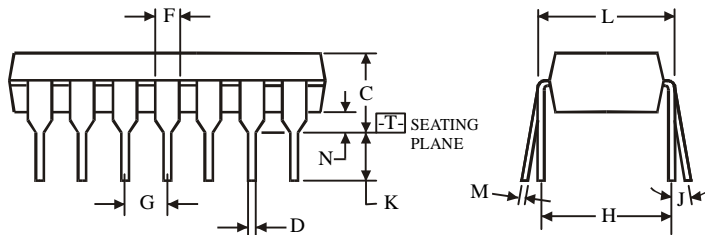
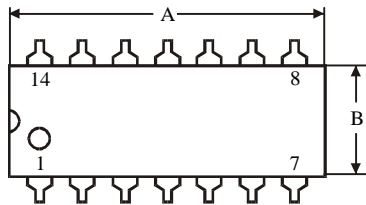
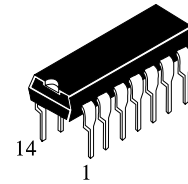

$\oplus 0.25 (0.010) \text{ (M) T}$

**NOTES:**

- Dimensions "A", "B" do not include mold flash or protrusions.  
Maximum mold flash or protrusions 0.25 mm (0.010) per side.

| Symbol | Dimension, mm |       |
|--------|---------------|-------|
|        | MIN           | MAX   |
| A      | 18.67         | 19.69 |
| B      | 6.1           | 7.11  |
| C      |               | 5.33  |
| D      | 0.36          | 0.56  |
| F      | 1.14          | 1.78  |
| G      | 2.54          |       |
| H      | 7.62          |       |
| J      | 0°            | 10°   |
| K      | 2.92          | 3.81  |
| L      | 7.62          | 8.26  |
| M      | 0.2           | 0.36  |
| N      | 0.38          |       |

**D SUFFIX SOIC  
(MS - 012AB)**

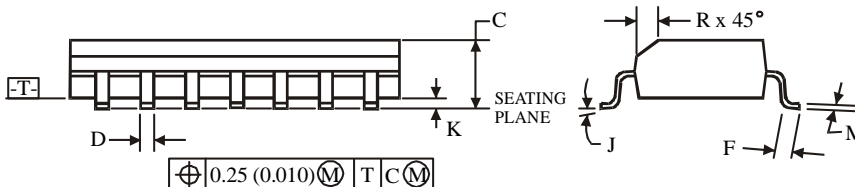
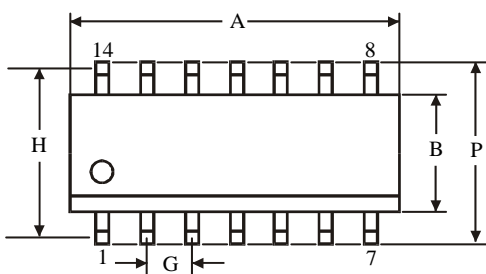
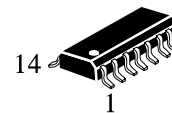

$\oplus 0.25 (0.010) \text{ (M) T C (M)}$

**NOTES:**

- Dimensions A and B do not include mold flash or protrusion.
- Maximum mold flash or protrusion 0.15 mm (0.006) per side for A; for B - 0.25 mm (0.010) per side.

| Symbol | Dimension, mm |      |
|--------|---------------|------|
|        | MIN           | MAX  |
| A      | 8.55          | 8.75 |
| B      | 3.8           | 4    |
| C      | 1.35          | 1.75 |
| D      | 0.33          | 0.51 |
| F      | 0.4           | 1.27 |
| G      | 1.27          |      |
| H      | 5.27          |      |
| J      | 0°            | 8°   |
| K      | 0.1           | 0.25 |
| M      | 0.19          | 0.25 |
| P      | 5.8           | 6.2  |
| R      | 0.25          | 0.5  |