

# IN74HC365

## HEX 3-STATE NONINVERTING BUFFER WITH COMMON ENABLES High-Performance Silicon-Gate CMOS

The IN74HC365 is identical in pinout to the LS/ALS365. The device inputs are compatible with standard CMOS outputs; with pullup resistors, they are compatible with LS/ALSTTL outputs.

This device is a high-speed hex buffer with 3-state outputs and two common active-low Output Enables. When either of the enables is high, the buffer outputs are placed into high-impedance states. The IN74HC365 has noninverting outputs.

- Outputs Directly Interface to CMOS, NMOS, and TTL
- Operating Voltage Range: 2.0 to 6.0 V
- Low Input Current: 1.0  $\mu$ A
- High Noise Immunity Characteristic of CMOS Devices

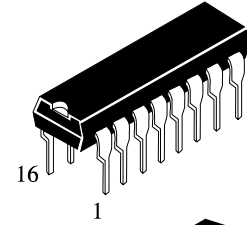

N SUFFIX  
PLASTIC

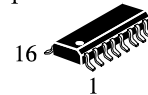

D SUFFIX  
SOIC

### ORDERING INFORMATION

IN74HC365N Plastic

IN74HC365D SOIC

$T_A = -55^\circ$  to  $125^\circ$  C for all packages

### PIN ASSIGNMENT

OUTPUT ENABLE 1	1 ●	16	$V_{CC}$
A0	2	15	OUTPUT ENABLE 2
Y0	3	14	A5
A1	4	13	Y5
Y1	5	12	A4
A2	6	11	Y4
Y2	7	10	A3
GND	8	9	Y3

### LOGIC DIAGRAM

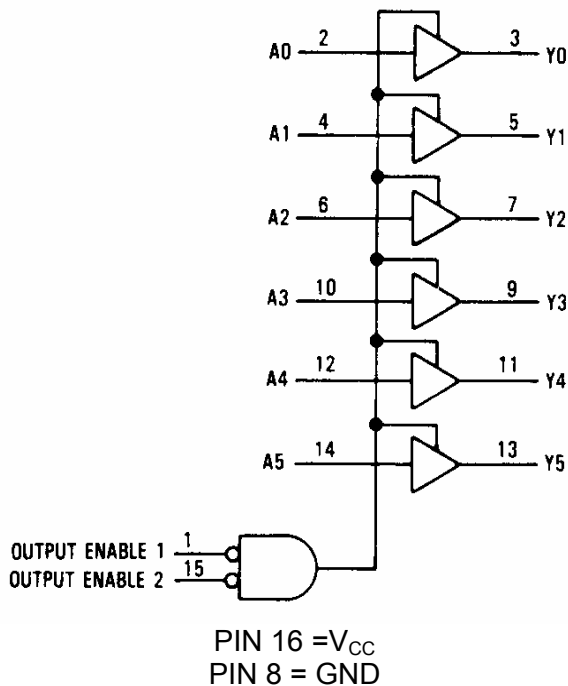

### FUNCTION TABLE

Inputs			Output
Enable 1	Enable 2	A	Y
L	L	L	L
L	L	H	H
H	X	X	Z
X	H	X	Z

Z = high impedance

X = don't care

# IN74HC365

## MAXIMUM RATINGS\*

Symbol	Parameter	Value	Unit
$V_{CC}$	DC Supply Voltage (Referenced to GND)	-0.5 to +7.0	V
$V_{IN}$	DC Input Voltage (Referenced to GND)	-1.5 to $V_{CC} + 1.5$	V
$V_{OUT}$	DC Output Voltage (Referenced to GND)	-0.5 to $V_{CC} + 0.5$	V
$I_{IN}$	DC Input Current, per Pin	$\pm 20$	mA
$I_{OUT}$	DC Output Current, per Pin	$\pm 35$	mA
$I_{CC}$	DC Supply Current, $V_{CC}$ and GND Pins	$\pm 75$	mA
$P_D$	Power Dissipation in Still Air, Plastic DIP+ SOIC Package+	750 500	mW
Tstg	Storage Temperature	-65 to +150	$^{\circ}\text{C}$
$T_L$	Lead Temperature, 1 mm from Case for 10 Seconds (Plastic DIP or SOIC Package)	260	$^{\circ}\text{C}$

\*Maximum Ratings are those values beyond which damage to the device may occur. Functional operation should be restricted to the Recommended Operating Conditions.

+Derating - Plastic DIP: - 10 mW/ $^{\circ}\text{C}$  from 65 $^{\circ}$  to 125 $^{\circ}\text{C}$

SOIC Package: : - 7 mW/ $^{\circ}\text{C}$  from 65 $^{\circ}$  to 125 $^{\circ}\text{C}$

## RECOMMENDED OPERATING CONDITIONS

Symbol	Parameter	Min	Max	Unit
$V_{CC}$	DC Supply Voltage (Referenced to GND)	2.0	6.0	V
$V_{IN}, V_{OUT}$	DC Input Voltage, Output Voltage (Referenced to GND)	0	$V_{CC}$	V
$T_A$	Operating Temperature, All Package Types	-55	+125	$^{\circ}\text{C}$
$t_r, t_f$	Input Rise and Fall Time (Figure 1)			ns
	$V_{CC} = 2.0 \text{ V}$	0	1000	
	$V_{CC} = 4.5 \text{ V}$	0	500	
	$V_{CC} = 6.0 \text{ V}$	0	400	

This device contains protection circuitry to guard against damage due to high static voltages or electric fields. However, precautions must be taken to avoid applications of any voltage higher than maximum rated voltages to this high-impedance circuit. For proper operation,  $V_{IN}$  and  $V_{OUT}$  should be constrained to the range  $\text{GND} \leq (V_{IN} \text{ or } V_{OUT}) \leq V_{CC}$ .

Unused inputs must always be tied to an appropriate logic voltage level (e.g., either GND or  $V_{CC}$ ). Unused outputs must be left open.

## IN74HC365

### DC ELECTRICAL CHARACTERISTICS (Voltages Referenced to GND)

Symbol	Parameter	Test Conditions	V <sub>CC</sub> V	Guaranteed Limit			Unit
				25 °C to -55°C	≤85 °C	≤125 °C	
V <sub>IH</sub>	Minimum High-Level Input Voltage	V <sub>OUT</sub> = V <sub>CC</sub> -0.1 V  I <sub>OUT</sub>   ≤ 20 μA	2.0	1.5	1.5	1.5	V
			4.5	3.15	3.15	3.15	
			6.0	4.2	4.2	4.2	
V <sub>IL</sub>	Maximum Low-Level Input Voltage	V <sub>OUT</sub> =0.1 V  I <sub>OUT</sub>   ≤ 20 μA	2.0	0.3	0.3	0.3	V
			4.5	0.9	0.9	0.9	
			6.0	1.2	1.2	1.2	
V <sub>OH</sub>	Minimum High-Level Output Voltage	V <sub>IN</sub> =V <sub>IH</sub>  I <sub>OUT</sub>   ≤ 20 μA	2.0	1.9	1.9	1.9	V
			4.5	4.4	4.4	4.4	
		6.0	5.9	5.9	5.9		
		V <sub>IN</sub> =V <sub>IH</sub>  I <sub>OUT</sub>   ≤ 6.0 mA  I <sub>OUT</sub>   ≤ 7.8 mA	4.5	3.98	3.84	3.7	
6.0	5.48	5.34	5.2				
V <sub>OL</sub>	Maximum Low-Level Output Voltage	V <sub>IN</sub> = V <sub>IL</sub>  I <sub>OUT</sub>   ≤ 20 μA	2.0	0.1	0.1	0.1	V
			4.5	0.1	0.1	0.1	
		6.0	0.1	0.1	0.1		
		V <sub>IN</sub> = V <sub>IL</sub>  I <sub>OUT</sub>   ≤ 6.0 mA  I <sub>OUT</sub>   ≤ 7.8 mA	4.5	0.26	0.33	0.4	
6.0	0.26	0.33	0.4				
I <sub>IN</sub>	Maximum Input Leakage Current	V <sub>IN</sub> =V <sub>CC</sub> or GND	6.0	±0.1	±1.0	±1.0	μA
I <sub>OZ</sub>	Maximum Three-State Leakage Current	Output in High-State Impedance V <sub>IN</sub> = V <sub>IL</sub> or V <sub>IH</sub> V <sub>OUT</sub> =V <sub>CC</sub> or GND	6.0	±0.5	±5.0	±10	μA
I <sub>CC</sub>	Maximum Quiescent Supply Current (per Package)	V <sub>IN</sub> =V <sub>CC</sub> or GND I <sub>OUT</sub> =0μA	6.0	8.0	80	160	μA

# IN74HC365

## AC ELECTRICAL CHARACTERISTICS ( $C_L=50\text{pF}$ , Input $t_r=t_f=6.0\text{ ns}$ )

Symbol	Parameter	$V_{CC}$ V	Guaranteed Limit			Unit
			25 °C to -55°C	≤85°C	≤125 °C	
$t_{PLH}$ , $t_{PHL}$	Maximum Propagation Delay, Input A to Output Y (Figures 1 and 3)	2.0 4.5 6.0	120 24 20	150 30 26	180 36 31	ns
$t_{PLZ}$ , $t_{PHZ}$	Maximum Propagation Delay, Output Enable to Output Y (Figures 2 and 4)	2.0 4.5 6.0	220 44 37	275 55 47	330 66 56	ns
$t_{PZL}$ , $t_{PZH}$	Maximum Propagation Delay, Output Enable to Output Y (Figures 2 and 4)	2.0 4.5 6.0	220 44 37	275 55 47	330 66 56	ns
$t_{TLH}$ , $t_{THL}$	Maximum Output Transition Time, Any Output (Figures 1 and 3)	2.0 4.5 6.0	60 12 10	75 15 13	90 18 15	ns
$C_{IN}$	Maximum Input Capacitance	-	10	10	10	pF
$C_{OUT}$	Maximum Three-State Output Capacitance (Output in High-Impedance State)	-	15	15	15	pF

$C_{PD}$	Power Dissipation Capacitance (Per Buffer) Used to determine the no-load dynamic power $P_D=C_{PD}V_{CC}^2f+I_{CC}V_{CC}$	Typical @25°C, $V_{CC}=5.0\text{ V}$			pF
		40			

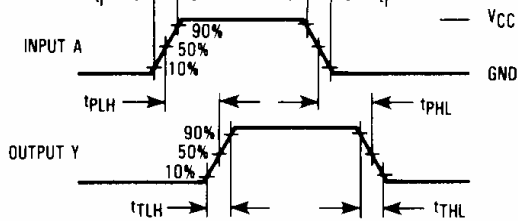

Figure 1. Switching Waveforms

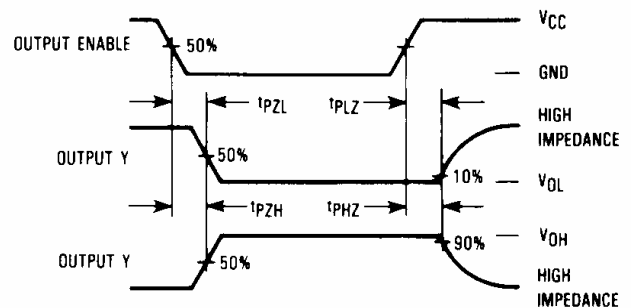
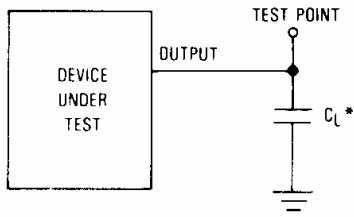
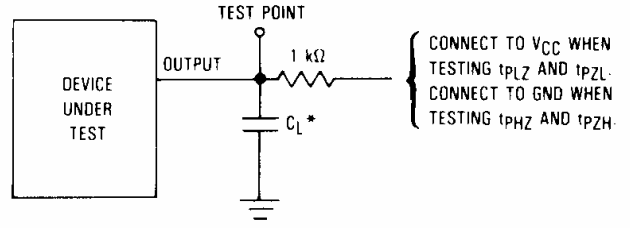

Figure 2. Switching Waveforms



\*Includes all probe and jig capacitance.

**Figure 3. Test Circuit**



\*Includes all probe and jig capacitance.

**Figure 4. Test Circuit**

## EXPANDED LOGIC DIAGRAM (1/6 of the Device)

