

IN74ACT257

QUAD 2-INPUT DATA SELECTOR/MULTIPLEXER WITH 3-STATE OUTPUTS High-Speed Silicon-Gate CMOS

The IN74ACT257 is identical in pinout to the LS/ALS257, HC/HCT257. The IN74ACT257 may be used as a level converter for interfacing TTL or NMOS outputs to High Speed CMOS inputs.

This device selects a (4-bit) nibble from either the A or B inputs as determined by the Select input. The nibble is presented at the outputs in noninverted form when the Output Enable pin is at a low level. A high level on the Output Enable pin switches the outputs into the high-impedance state.

- TTL/NMOS Compatible Input Levels
- Outputs Directly Interface to CMOS, NMOS, and TTL
- Operating Voltage Range: 4.5 to 5.5 V
- Low Input Current: 1.0 μ A; 0.1 μ A @ 25°C
- Outputs Source/Sink 24 mA

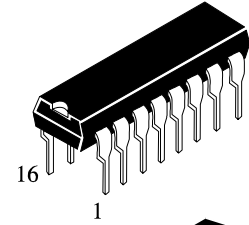

N SUFFIX
PLASTIC

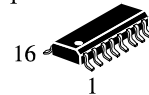

D SUFFIX
SOIC

ORDERING INFORMATION

IN74ACT257N Plastic
IN74ACT257D SOIC

$T_A = -40^\circ$ to 85° C for all packages

PIN ASSIGNMENT

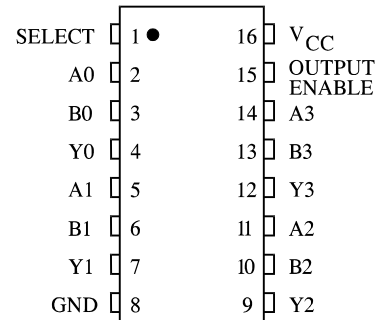

LOGIC DIAGRAM

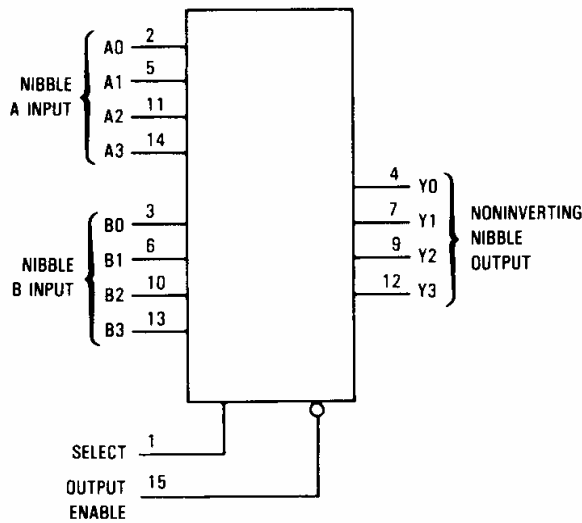

PIN 16 = V_{CC}
PIN 8 = GND

FUNCTION TABLE

Inputs		Outputs
Output Enable	Select	Y0-Y3
H	X	Z
L	L	A0-A3
L	H	B0-B3

X=don't care
Z = high-impedance state
A0-A3,B0-B3=the levels of the respective Nibble Inputs

IN74ACT257

MAXIMUM RATINGS*

Symbol	Parameter	Value	Unit
V _{CC}	DC Supply Voltage (Referenced to GND)	-0.5 to +7.0	V
V _{IN}	DC Input Voltage (Referenced to GND)	-0.5 to V _{CC} +0.5	V
V _{OUT}	DC Output Voltage (Referenced to GND)	-0.5 to V _{CC} +0.5	V
I _{IN}	DC Input Current, per Pin	±20	mA
I _{OUT}	DC Output Sink/Source Current, per Pin	±50	mA
I _{CC}	DC Supply Current, V _{CC} and GND Pins	±50	mA
P _D	Power Dissipation in Still Air, Plastic DIP+ SOIC Package+	750 500	mW
T _{stg}	Storage Temperature	-65 to +150	°C
T _L	Lead Temperature, 1 mm from Case for 10 Seconds (Plastic DIP or SOIC Package)	260	°C

Maximum Ratings are those values beyond which damage to the device may occur. Functional operation should be restricted to the Recommended Operating Conditions.

+Derating - Plastic DIP: - 10 mW/°C from 65° to 125°C
SOIC Package: - 7 mW/°C from 65° to 125°C

RECOMMENDED OPERATING CONDITIONS

Symbol	Parameter	Min	Max	Unit
V _{CC}	DC Supply Voltage (Referenced to GND)	4.5	5.5	V
V _{IN} , V _{OUT}	DC Input Voltage, Output Voltage (Referenced to GND)	0	V _{CC}	V
T _J	Junction Temperature (PDIP)		140	°C
T _A	Operating Temperature, All Package Types	-40	+85	°C
I _{OH}	Output Current - High		-24	mA
I _{OL}	Output Current - Low		24	mA
t _r , t _f	Input Rise and Fall Time * (except Schmitt Inputs)	V _{CC} =4.5 V 0	10	ns/V
		V _{CC} =5.5 V 0	8.0	

*V_{IN} from 0.8 V to 2.0 V

This device contains protection circuitry to guard against damage due to high static voltages or electric fields. However, precautions must be taken to avoid applications of any voltage higher than maximum rated voltages to this high-impedance circuit. For proper operation, V_{IN} and V_{OUT} should be constrained to the range GND ≤ (V_{IN} or V_{OUT}) ≤ V_{CC}.

Unused inputs must always be tied to an appropriate logic voltage level (e.g., either GND or V_{CC}). Unused outputs must be left open.

IN74ACT257

DC ELECTRICAL CHARACTERISTICS (Voltages Referenced to GND)

Symbol	Parameter	Test Conditions	V _{CC} V	Guaranteed Limits		Unit
				25 °C	-40°C to 85°C	
V _{IH}	Minimum High-Level Input Voltage	V _{OUT} =0.1 V or V _{CC} -0.1 V	4.5 5.5	2.0 2.0	2.0 2.0	V
V _{IL}	Maximum Low-Level Input Voltage	V _{OUT} =0.1 V or V _{CC} -0.1 V	4.5 5.5	0.8 0.8	0.8 0.8	V
V _{OH}	Minimum High-Level Output Voltage	I _{OUT} ≤ -50 μA	4.5 5.5	4.4 5.4	4.4 5.4	V
		V _{IN} =V _{IH} or V _{IL} I _{OH} =-24 mA I _{OH} =-24 mA	4.5 5.5	3.86 4.86	3.76 4.76	
V _{OL}	Maximum Low-Level Output Voltage	I _{OUT} ≤ 50 μA	4.5 5.5	0.1 0.1	0.1 0.1	V
		V _{IN} =V _{IH} or V _{IL} I _{OL} =24 mA I _{OL} =24 mA	4.5 5.5	0.36 0.36	0.44 0.44	
I _{IN}	Maximum Input Leakage Current	V _{IN} =V _{CC} or GND	5.5	±0.1	±1.0	μA
ΔI _{CCCT}	Additional Max. I _{CC} /Input	V _{IN} =V _{CC} - 2.1 V	5.5		1.5	mA
I _{OZ}	Maximum Three-State Leakage Current	V _{IN} (OE)= V _{IH} or V _{IL} V _{IN} =V _{CC} or GND V _{OUT} =V _{CC} or GND	5.5	±0.5	±5.0	μA
I _{OLD}	+Minimum Dynamic Output Current	V _{OLD} =1.65 V Max	5.5		75	mA
I _{OHD}	+Minimum Dynamic Output Current	V _{OHD} =3.85 V Min	5.5		-75	mA
I _{CC}	Maximum Quiescent Supply Current (per Package)	V _{IN} =V _{CC} or GND	5.5	8.0	80	μA

All outputs loaded; thresholds on input associated with output under test.

+Maximum test duration 2.0 ms, one output loaded at a time.

IN74ACT257

AC ELECTRICAL CHARACTERISTICS ($V_{CC}=5.0\text{ V} \pm 10\%$, $C_L=50\text{ pF}$, Input $t_r=t_f=3.0\text{ ns}$)

Symbol	Parameter	Guaranteed Limits				Unit
		25 °C		-40°C to 85°C		
		Min	Max	Min	Max	
t_{PLH}	Propagation Delay, Nibble A or B to Output Y (Figure 1)	1.5	7.0	1.0	7.5	ns
t_{PHL}	Propagation Delay, Nibble A or B to Output Y (Figure 1)	2.0	7.5	1.5	8.5	ns
t_{PLH}	Propagation Delay, Select to Output Y (Figure 2)	2.0	9.5	1.5	10.5	ns
t_{PHL}	Propagation Delay, Select to Output Y (Figure 2)	2.5	10.5	2.0	11.5	ns
t_{PZH}	Propagation Delay, Output Enable to Output Y (Figure 3)	2.0	8.0	1.5	9.0	ns
t_{PZL}	Propagation Delay, Output Enable to Output Y (Figure 3)	2.0	8.0	1.5	9.0	ns
t_{PHZ}	Propagation Delay, Output Enable to Output Y (Figure 3)	2.5	9.0	1.5	10.0	ns
t_{PLZ}	Propagation Delay, Output Enable to Output Y (Figure 3)	2.0	7.5	1.5	8.5	ns
C_{IN}	Maximum Input Capacitance	4.5		4.5		pF

C_{PD}	Power Dissipation Capacitance	Typical @25°C, $V_{CC}=5.0\text{ V}$		pF
		50		

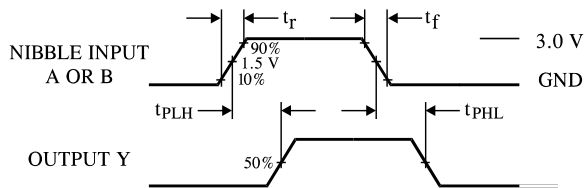

Figure 1. Switching Waveforms

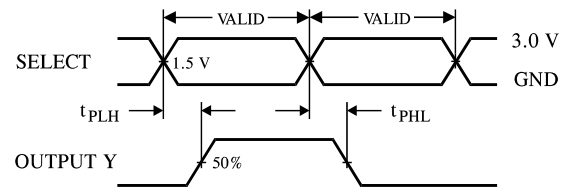

Figure 2. Switching Waveforms

IN74ACT257

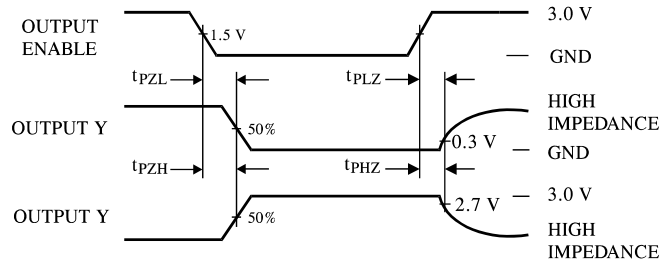

Figure 3. Switching Waveforms

EXPANDED LOGIC DIAGRAM

