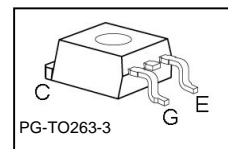
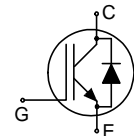


Low Loss DuoPack : IGBT in TRENCHSTOP™ and Fieldstop technology with soft, fast recovery anti-parallel Emitter Controlled HE diode



### Features:

- Very low  $V_{CE(sat)}$  1.5V (typ.)
- Maximum Junction Temperature 175°C
- Short circuit withstand time 5 $\mu$ s
- Designed for frequency inverters for washing machines, fans, pumps and vacuum cleaners
- TRENCHSTOP™ and Fieldstop technology for 600V applications offers :
  - very tight parameter distribution
  - high ruggedness, temperature stable behavior
  - very high switching speed
- Positive temperature coefficient in  $V_{CE(sat)}$
- Low EMI
- Low Gate Charge
- Qualified according to JEDEC<sup>1</sup> for target applications
- Pb-free lead plating; RoHS compliant
- Complete product spectrum and PSpice Models : <http://www.infineon.com/igbt/>



Type	$V_{CE}$	$I_C$	$V_{CE(sat), T_j=25^\circ C}$	$T_{j,max}$	Marking	Package
IKB20N60T	600V	20A	1.5V	175°C	K20T60	PG-T0263-3

### Maximum Ratings

Parameter	Symbol	Value	Unit
Collector-emitter voltage, $T_j \geq 25^\circ C$	$V_{CE}$	600	V
DC collector current, limited by $T_{j,max}$	$I_C$	$T_C = 25^\circ C$	40
$T_C = 100^\circ C$		20	
Pulsed collector current, $t_p$ limited by $T_{j,max}$		$I_{C,puls}$	60
Turn off safe operating area, $V_{CE} = 600V$ , $T_j = 175^\circ C$ , $t_p = 1\mu s$	-	60	
Diode forward current, limited by $T_{j,max}$	$I_F$	$T_C = 25^\circ C$	40
		$T_C = 100^\circ C$	20
Diode pulsed current, $t_p$ limited by $T_{j,max}$	$I_{F,puls}$	60	
Gate-emitter voltage	$V_{GE}$	$\pm 20$	V
Short circuit withstand time <sup>2)</sup>	$t_{SC}$	5	$\mu s$
$V_{GE} = 15V$ , $V_{CC} \leq 400V$ , $T_j \leq 150^\circ C$			
Power dissipation $T_C = 25^\circ C$	$P_{tot}$	166	W
Operating junction temperature	$T_j$	-40...+175	
Storage temperature	$T_{stg}$	-55...+150	$^\circ C$
Soldering temperature (reflow soldering, MSL1)	-	260	

<sup>1</sup> J-STD-020 and JESD-022

<sup>2)</sup> Allowed number of short circuits: <1000; time between short circuits: >1s.

### Thermal Resistance

Parameter	Symbol	Conditions	Max. Value	Unit
<b>Characteristic</b>				
IGBT thermal resistance, junction – case	$R_{thJC}$		0.9	K/W
Diode thermal resistance, junction – case	$R_{thJCD}$		1.5	
Thermal resistance, junction – ambient	$R_{thJA}$	6cm <sup>2</sup> Cu	40	

### Electrical Characteristic, at $T_j = 25^\circ\text{C}$ , unless otherwise specified

Parameter	Symbol	Conditions	Value			Unit
			min.	Typ.	max.	
<b>Static Characteristic</b>						
Collector-emitter breakdown voltage	$V_{(BR)CES}$	$V_{GE}=0V, I_C=0.2mA$	600	-	-	V
Collector-emitter saturation voltage	$V_{CE(sat)}$	$V_{GE} = 15V, I_C=20A$ $T_j=25^\circ\text{C}$ $T_j=175^\circ\text{C}$	-	1.5	2.05	
Diode forward voltage	$V_F$	$V_{GE}=0V, I_F=20A$ $T_j=25^\circ\text{C}$ $T_j=175^\circ\text{C}$	-	1.65	2.05	
Gate-emitter threshold voltage	$V_{GE(th)}$	$I_C=290\mu A, V_{CE}=V_{GE}$	4.1	4.9	5.7	
Zero gate voltage collector current	$I_{CES}$	$V_{CE}=600V,$ $V_{GE}=0V$ $T_j=25^\circ\text{C}$ $T_j=175^\circ\text{C}$	-	-	40	$\mu A$
Gate-emitter leakage current	$I_{GES}$	$V_{CE}=0V, V_{GE}=20V$	-	-	100	
Transconductance	$g_{fs}$	$V_{CE}=20V, I_C=20A$	-	11	-	S
Integrated gate resistor	$R_{Gint}$			-		$\Omega$

### Dynamic Characteristic

Input capacitance	$C_{iss}$	$V_{CE}=25V,$ $V_{GE}=0V,$ $f=1MHz$	-	1100	-	pF
Output capacitance	$C_{oss}$		-	71	-	
Reverse transfer capacitance	$C_{riss}$		-	32	-	
Gate charge	$Q_{Gate}$	$V_{CC}=480V, I_C=20A$ $V_{GE}=15V$	-	120	-	nC
Internal emitter inductance measured 5mm (0.197 in.) from case	$L_E$		-	7	-	nH
Short circuit collector current <sup>1)</sup>	$I_{C(SC)}$	$V_{GE}=15V, t_{SC}\leq 5\mu s$ $V_{CC} = 400V,$ $T_j \leq 150^\circ\text{C}$	-	183.3	-	A

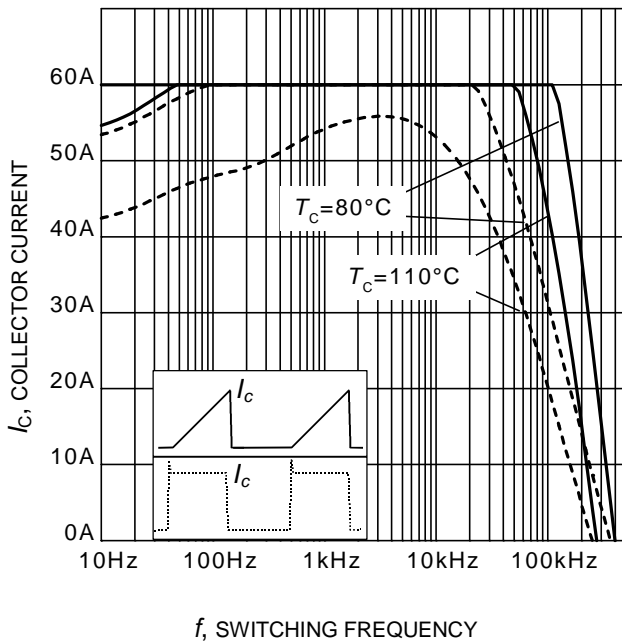
<sup>1)</sup> Allowed number of short circuits: <1000; time between short circuits: >1s.

### Switching Characteristic, Inductive Load, at $T_j=25^\circ\text{C}$

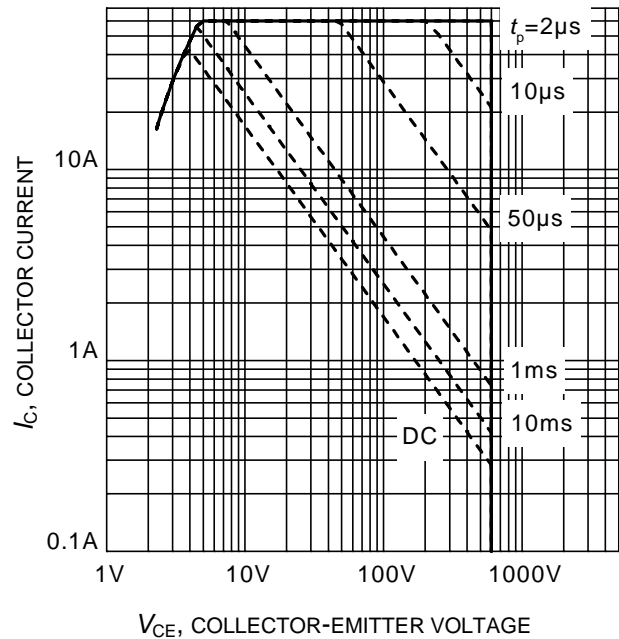
Parameter	Symbol	Conditions	Value			Unit	
			min.	Typ.	max.		
<b>IGBT Characteristic</b>							
Turn-on delay time	$t_{d(on)}$	$T_j=25^\circ\text{C}$ , $V_{CC}=400\text{V}$ , $I_C=20\text{A}$ , $V_{GE}=0/15\text{V}$ , $r_G=12\Omega$ , $L_\sigma=131\text{nH}$ , $C_\sigma=31\text{pF}$	-	18	-	ns	
Rise time	$t_r$		-	14	-		
Turn-off delay time	$t_{d(off)}$		-	199	-		
Fall time	$t_f$		-	42	-		
Turn-on energy	$E_{on}$	$L_\sigma$ , $C_\sigma$ from Fig. E Energy losses include "tail" and diode reverse recovery.	-	0.31	-	mJ	
Turn-off energy	$E_{off}$		-	0.46	-		
Total switching energy	$E_{ts}$		-	0.77	-		
<b>Anti-Parallel Diode Characteristic</b>							
Diode reverse recovery time	$t_{rr}$	$T_j=25^\circ\text{C}$ , $V_R=400\text{V}$ , $I_F=20\text{A}$ , $di_F/dt=880\text{A}/\mu\text{s}$	-	41	-	ns	
Diode reverse recovery charge	$Q_{rr}$		-	0.31	-		$\mu\text{C}$
Diode peak reverse recovery current	$I_{rrm}$		-	13.3	-		
Diode peak rate of fall of reverse recovery current during $t_b$	$di_{rr}/dt$		-	711	-		$\text{A}/\mu\text{s}$

### Switching Characteristic, Inductive Load, at $T_j=175^\circ\text{C}$

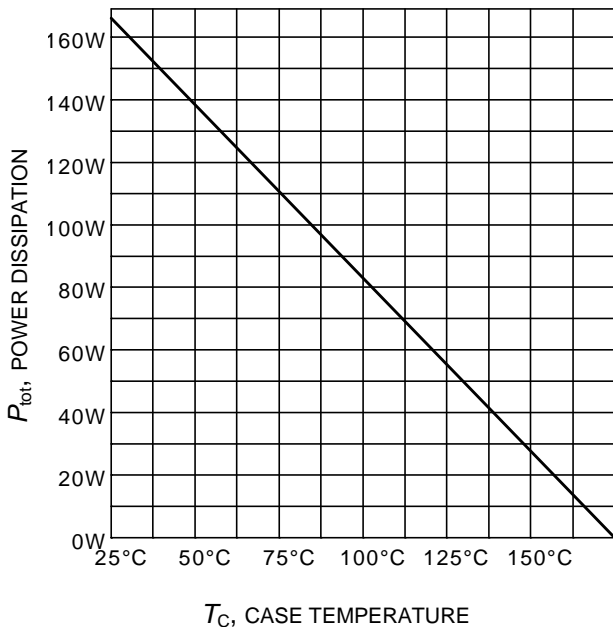
Parameter	Symbol	Conditions	Value			Unit	
			min.	Typ.	max.		
<b>IGBT Characteristic</b>							
Turn-on delay time	$t_{d(on)}$	$T_j=175^\circ\text{C}$ , $V_{CC}=400\text{V}$ , $I_C=20\text{A}$ , $V_{GE}=0/15\text{V}$ , $r_G=12\Omega$ , $L_\sigma=131\text{nH}$ , $C_\sigma=31\text{pF}$	-	18	-	ns	
Rise time	$t_r$		-	18	-		
Turn-off delay time	$t_{d(off)}$		-	223	-		
Fall time	$t_f$		-	76	-		
Turn-on energy	$E_{on}$	$L_\sigma$ , $C_\sigma$ from Fig. E Energy losses include "tail" and diode reverse recovery.	-	0.51	-	mJ	
Turn-off energy	$E_{off}$		-	0.64	-		
Total switching energy	$E_{ts}$		-	1.15	-		
<b>Anti-Parallel Diode Characteristic</b>							
Diode reverse recovery time	$t_{rr}$	$T_j=175^\circ\text{C}$ $V_R=400\text{V}$ , $I_F=20\text{A}$ , $di_F/dt=880\text{A}/\mu\text{s}$	-	176	-	ns	
Diode reverse recovery charge	$Q_{rr}$		-	1.46	-		$\mu\text{C}$
Diode peak reverse recovery current	$I_{rrm}$		-	18.9	-		
Diode peak rate of fall of reverse recovery current during $t_b$	$di_{rr}/dt$		-	467	-		$\text{A}/\mu\text{s}$



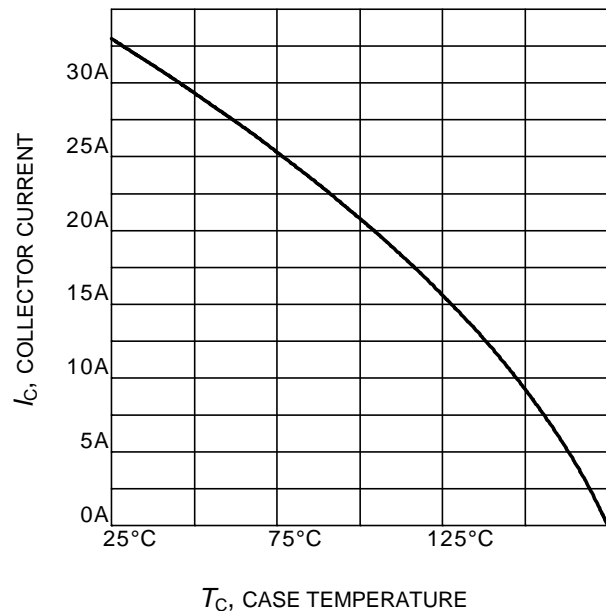
**Figure 1. Collector current as a function of switching frequency**  
 ( $T_j \leq 175^\circ\text{C}$ ,  $D = 0.5$ ,  $V_{CE} = 400\text{V}$ ,  $V_{GE} = 0/15\text{V}$ ,  $r_G = 12\Omega$ )



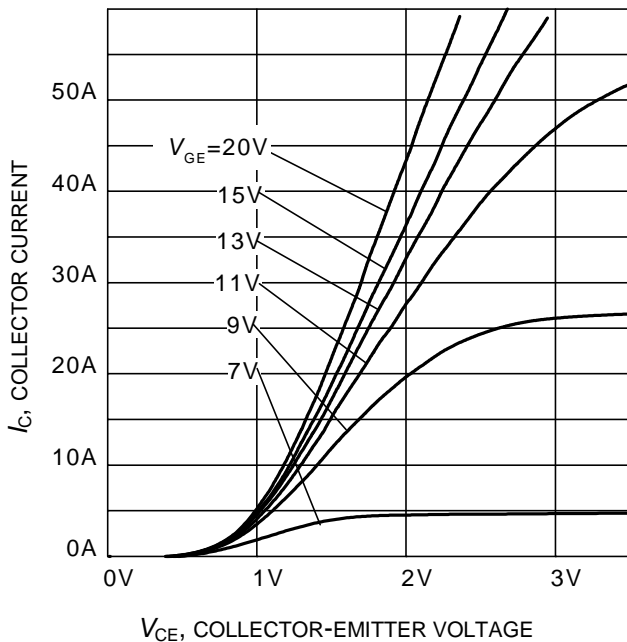
**Figure 2. Safe operating area**  
 ( $D = 0$ ,  $T_C = 25^\circ\text{C}$ ,  $T_j \leq 175^\circ\text{C}$ ;  $V_{GE} = 0/15\text{V}$ )



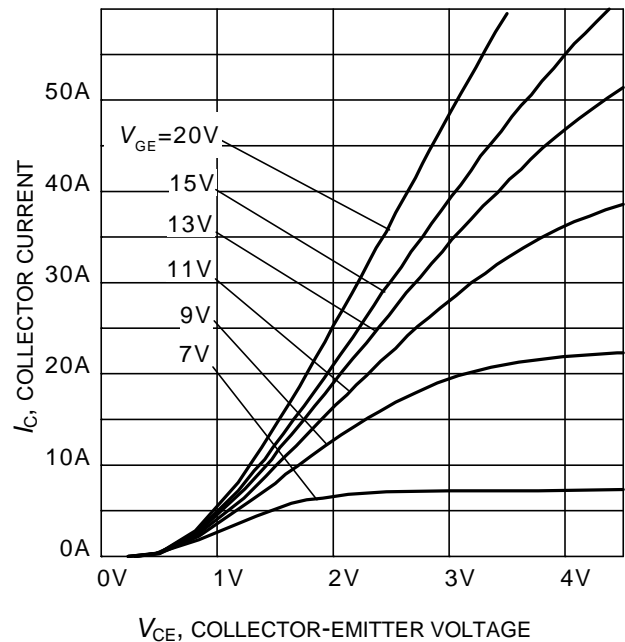
**Figure 3. Power dissipation as a function of case temperature**  
 ( $T_j \leq 175^\circ\text{C}$ )



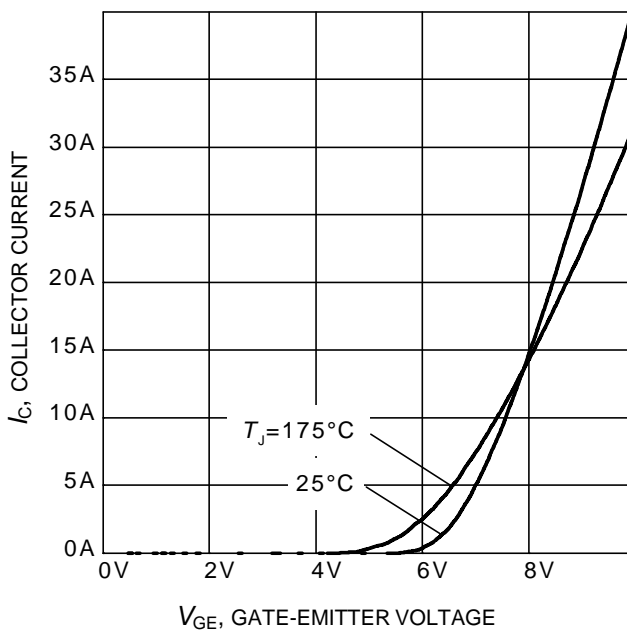
**Figure 4. Collector current as a function of case temperature**  
 ( $V_{GE} \geq 15\text{V}$ ,  $T_j \leq 175^\circ\text{C}$ )



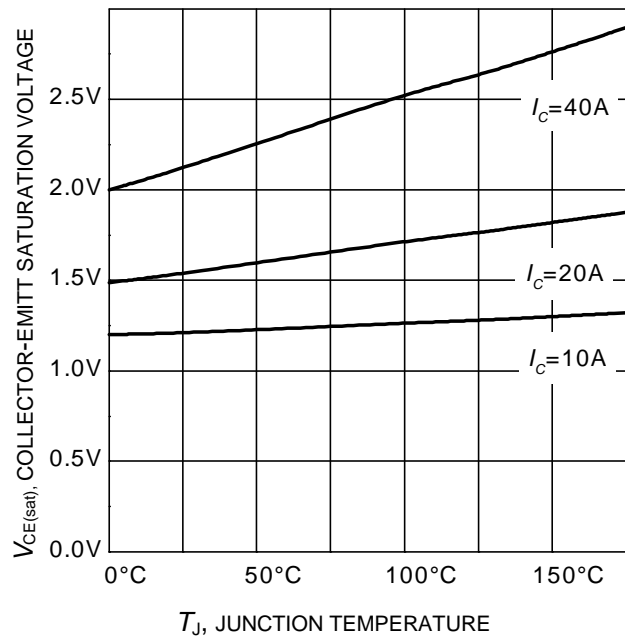
**Figure 5. Typical output characteristic**  
( $T_j = 25^\circ\text{C}$ )



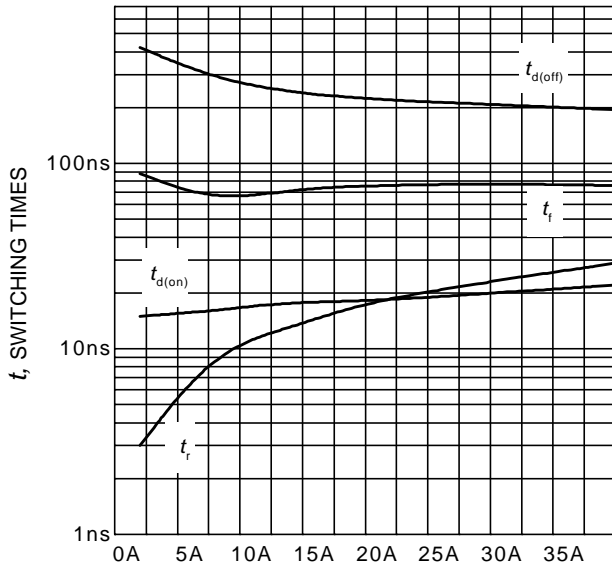
**Figure 6. Typical output characteristic**  
( $T_j = 175^\circ\text{C}$ )



**Figure 7. Typical transfer characteristic**  
( $V_{CE} = 10\text{V}$ )

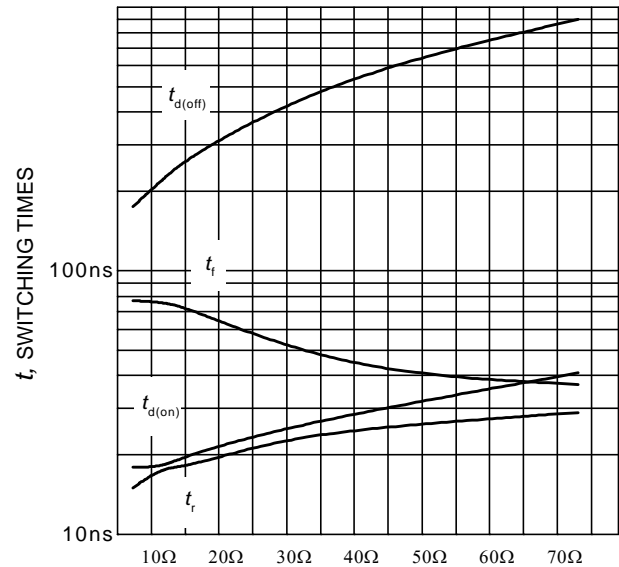


**Figure 8. Typical collector-emitter saturation voltage as a function of junction temperature**  
( $V_{GE} = 15\text{V}$ )



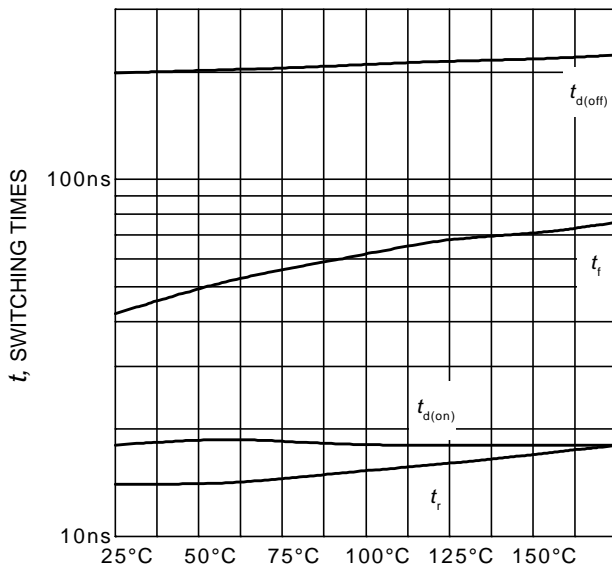
$I_C$ , COLLECTOR CURRENT

**Figure 9. Typical switching times as a function of collector current**  
(inductive load,  $T_J=175^\circ\text{C}$ ,  
 $V_{CE} = 400\text{V}$ ,  $V_{GE} = 0/15\text{V}$ ,  $r_G = 12\Omega$ ,  
Dynamic test circuit in Figure E)



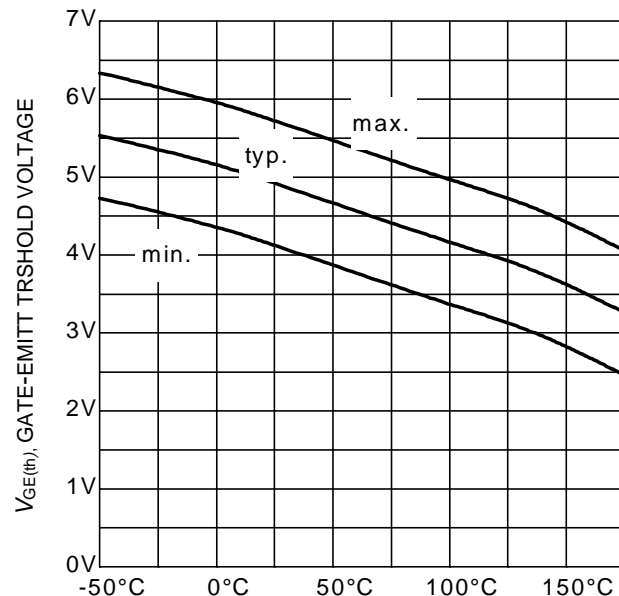
$R_G$ , GATE RESISTOR

**Figure 10. Typical switching times as a function of gate resistor**  
(inductive load,  $T_J = 175^\circ\text{C}$ ,  
 $V_{CE} = 400\text{V}$ ,  $V_{GE} = 0/15\text{V}$ ,  $I_C = 20\text{A}$ ,  
Dynamic test circuit in Figure E)



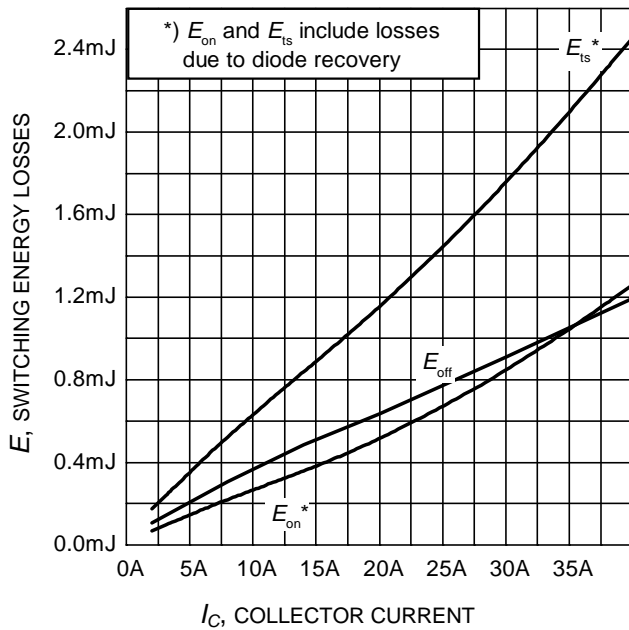
$T_J$ , JUNCTION TEMPERATURE

**Figure 11. Typical switching times as a function of junction temperature**  
(inductive load,  $V_{CE} = 400\text{V}$ ,  
 $V_{GE} = 0/15\text{V}$ ,  $I_C = 20\text{A}$ ,  $r_G=12\Omega$ ,  
Dynamic test circuit in Figure E)

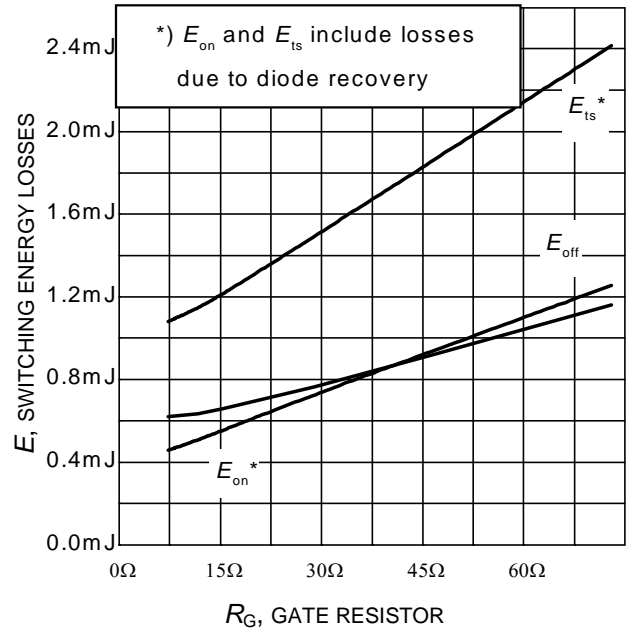


$T_J$ , JUNCTION TEMPERATURE

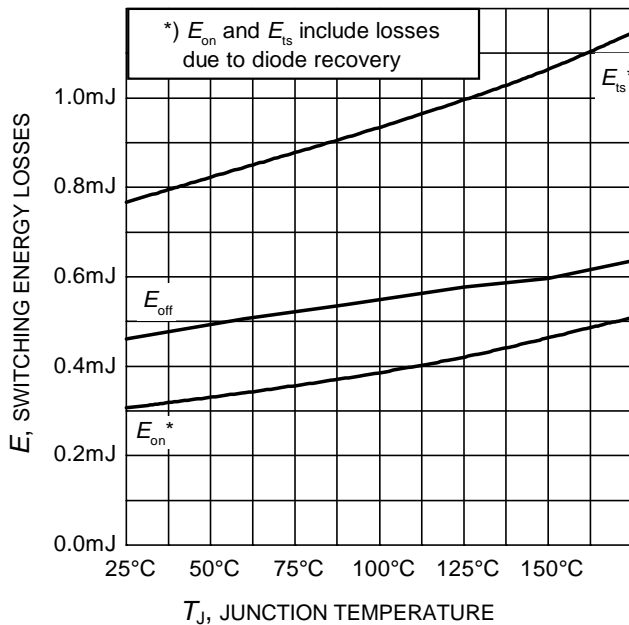
**Figure 12. Gate-emitter threshold voltage as a function of junction temperature**  
( $I_C = 0.29\text{mA}$ )



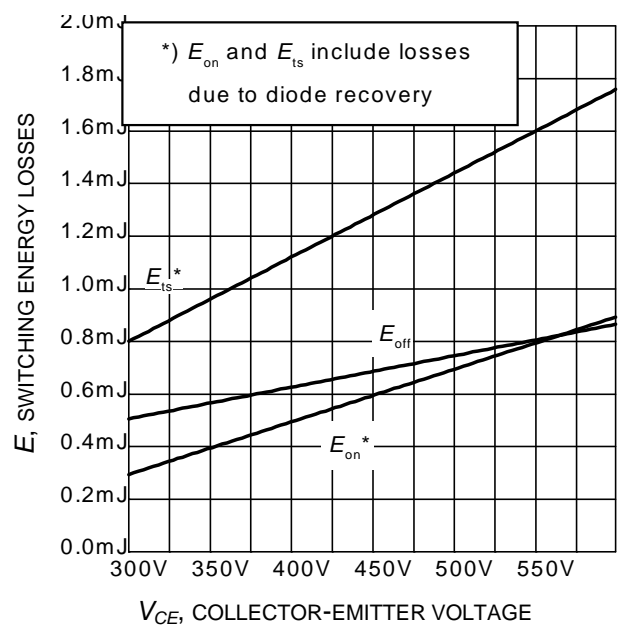
**Figure 13. Typical switching energy losses as a function of collector current**  
(inductive load,  $T_J = 175^\circ\text{C}$ ,  $V_{CE} = 400\text{V}$ ,  $V_{GE} = 0/15\text{V}$ ,  $r_G = 12\Omega$ , Dynamic test circuit in Figure E)



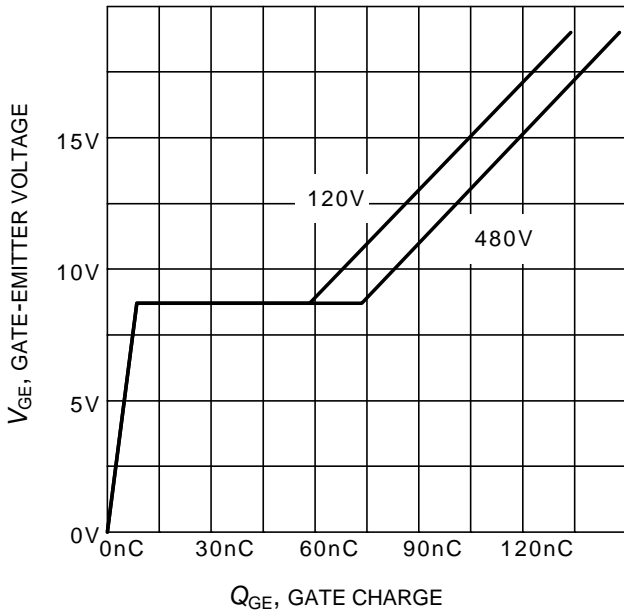
**Figure 14. Typical switching energy losses as a function of gate resistor**  
(inductive load,  $T_J = 175^\circ\text{C}$ ,  $V_{CE} = 400\text{V}$ ,  $V_{GE} = 0/15\text{V}$ ,  $I_C = 20\text{A}$ , Dynamic test circuit in Figure E)



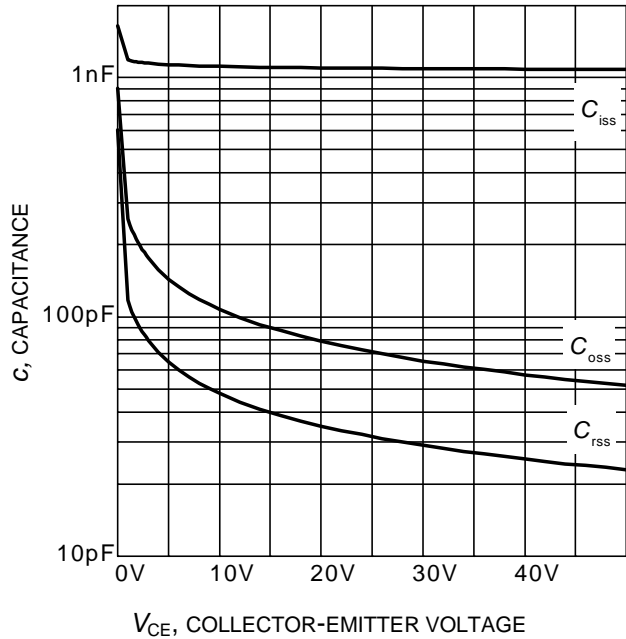
**Figure 15. Typical switching energy losses as a function of junction temperature**  
(inductive load,  $V_{CE} = 400\text{V}$ ,  $V_{GE} = 0/15\text{V}$ ,  $I_C = 20\text{A}$ ,  $r_G = 12\Omega$ , Dynamic test circuit in Figure E)



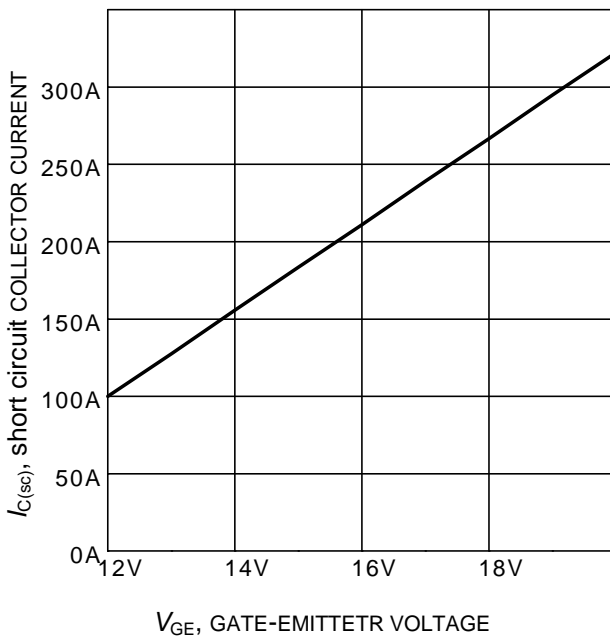
**Figure 16. Typical switching energy losses as a function of collector emitter voltage**  
(inductive load,  $T_J = 175^\circ\text{C}$ ,  $V_{GE} = 0/15\text{V}$ ,  $I_C = 20\text{A}$ ,  $r_G = 12\Omega$ , Dynamic test circuit in Figure E)



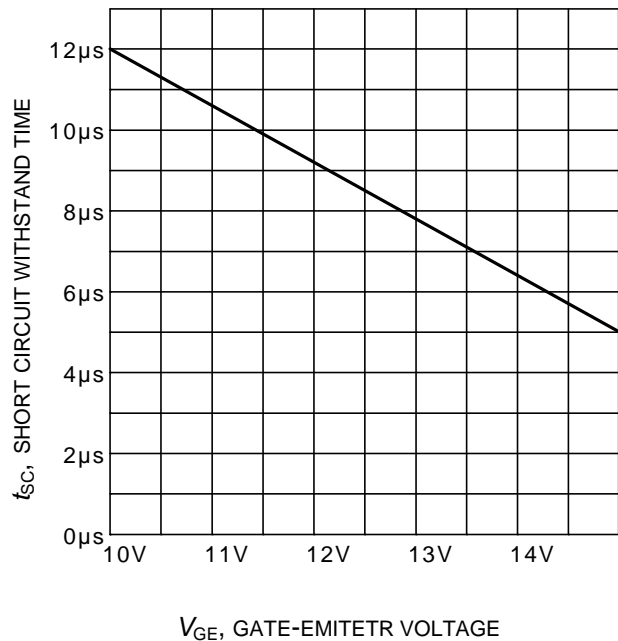
**Figure 17. Typical gate charge**  
( $I_C=20\text{ A}$ )



**Figure 18. Typical capacitance as a function of collector-emitter voltage**  
( $V_{GE}=0\text{V}$ ,  $f = 1\text{ MHz}$ )

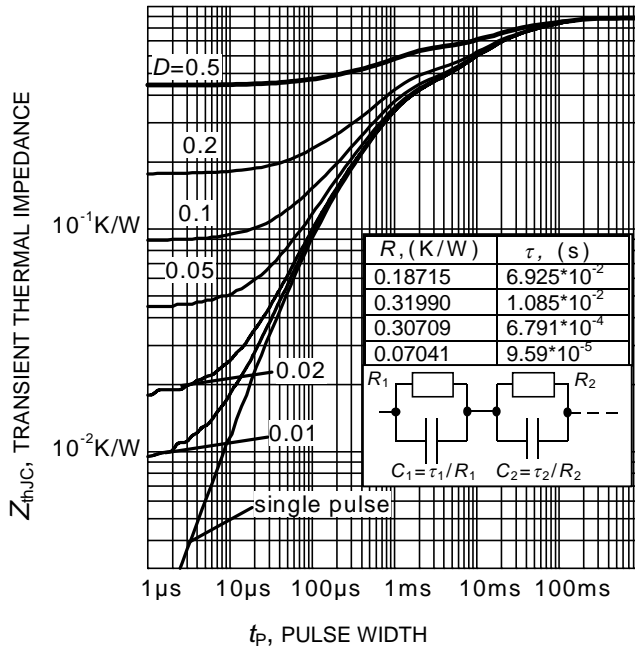


**Figure 19. Typical short circuit collector current as a function of gate-emitter voltage**  
( $V_{CE} \leq 400\text{V}$ ,  $T_j \leq 150^\circ\text{C}$ )

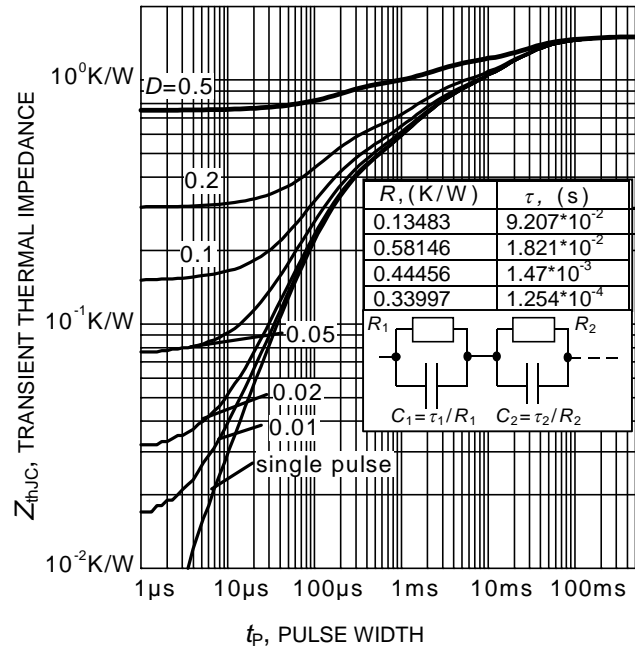


**Figure 20. Short circuit withstand time as a function of gate-emitter voltage**  
( $V_{CE}=400\text{V}$ , start at  $T_j=25^\circ\text{C}$ ,  $T_{jmax}<150^\circ\text{C}$ )

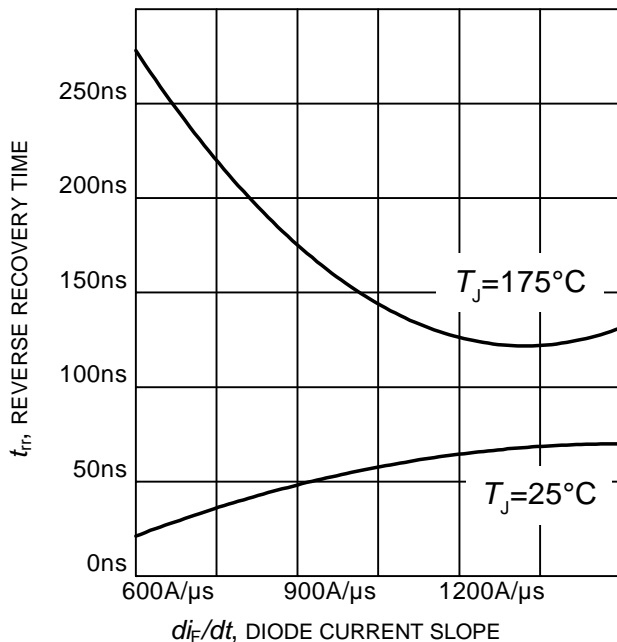




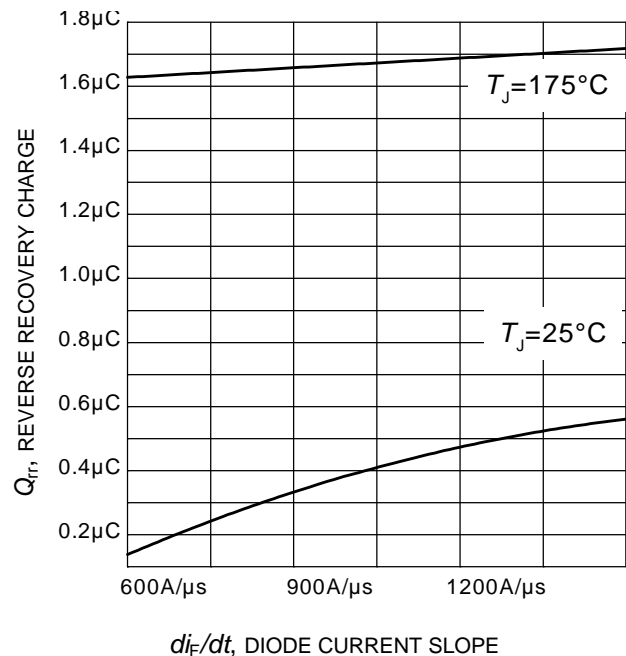
**Figure 21. IGBT transient thermal impedance**  
( $D = t_p / T$ )



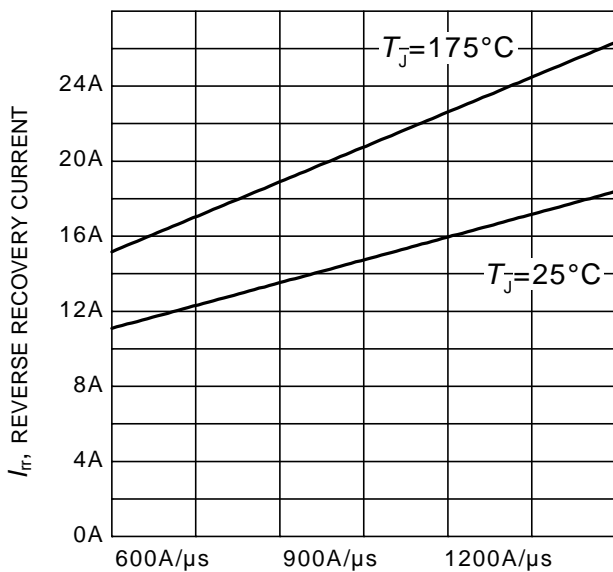
**Figure 22. Diode transient thermal impedance as a function of pulse width**  
( $D = t_p / T$ )



**Figure 23. Typical reverse recovery time as a function of diode current slope**  
( $V_R = 400V$ ,  $I_F = 20A$ ,  
Dynamic test circuit in Figure E)



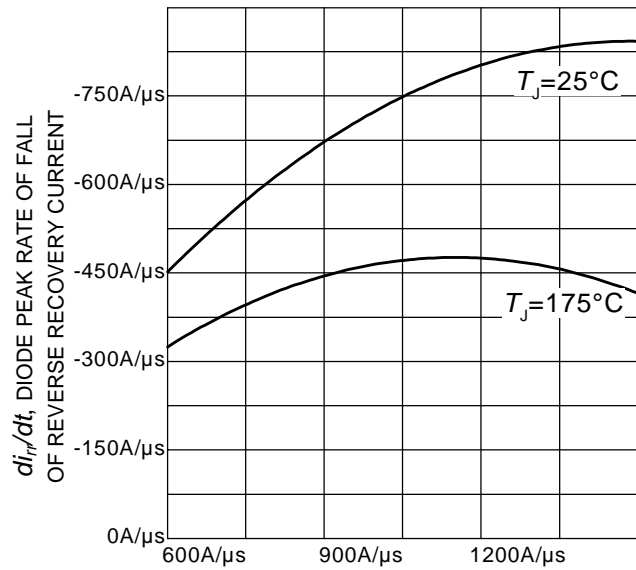
**Figure 24. Typical reverse recovery charge as a function of diode current slope**  
( $V_R = 400V$ ,  $I_F = 20A$ ,  
Dynamic test circuit in Figure E)



$di_F/dt$ , DIODE CURRENT SLOPE

**Figure 25. Typical reverse recovery current as a function of diode current slope**

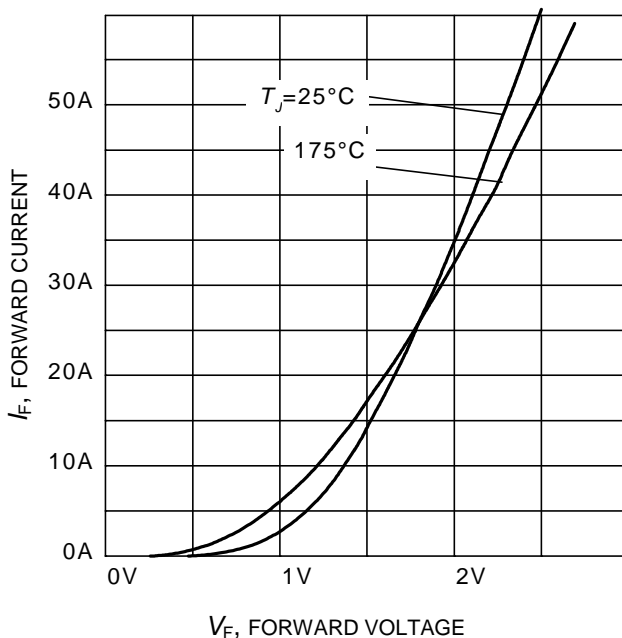
( $V_R = 400V$ ,  $I_F = 20A$ ,  
Dynamic test circuit in Figure E)



$di_F/dt$ , DIODE CURRENT SLOPE

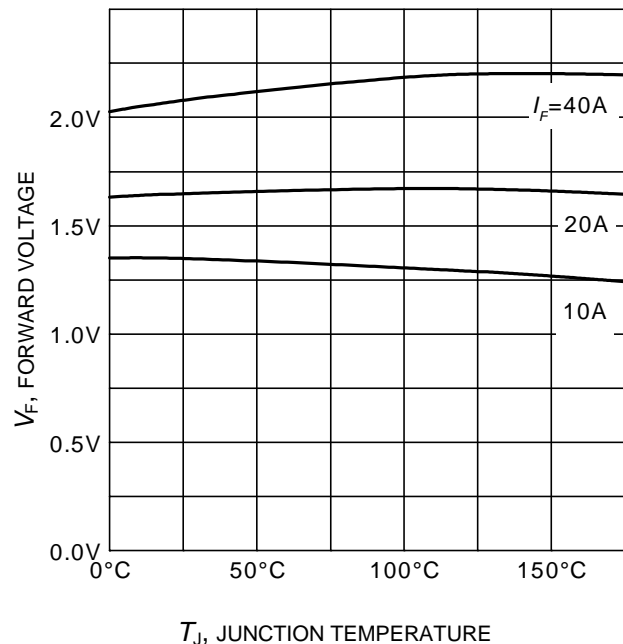
**Figure 26. Typical diode peak rate of fall of reverse recovery current as a function of diode current slope**

( $V_R = 400V$ ,  $I_F = 20A$ ,  
Dynamic test circuit in Figure E)



$V_F$ , FORWARD VOLTAGE

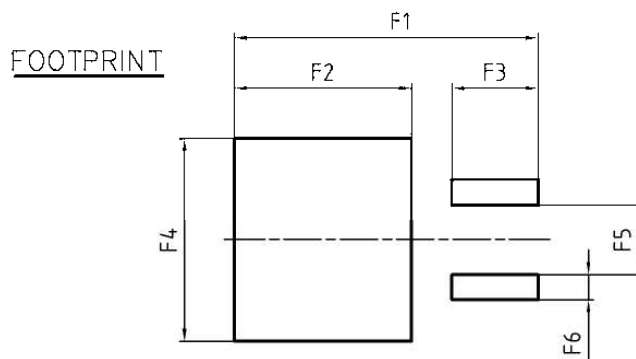
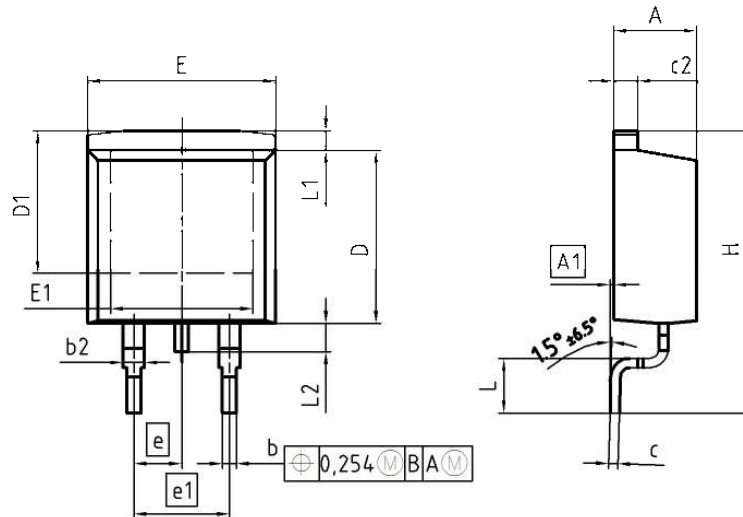
**Figure 27. Typical diode forward current as a function of forward voltage**



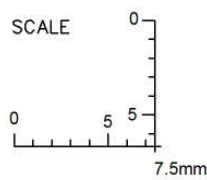
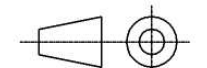
$T_J$ , JUNCTION TEMPERATURE

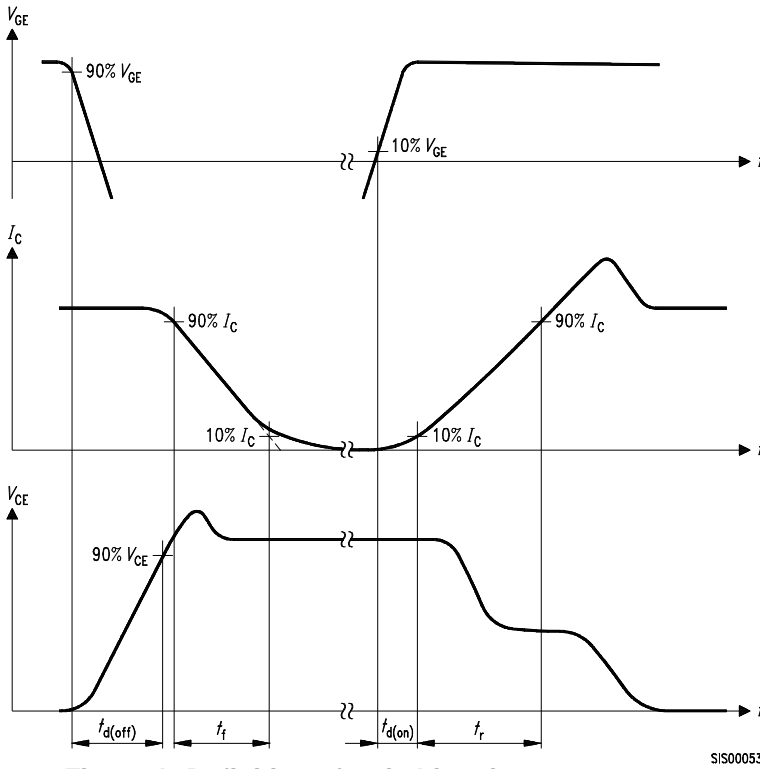
**Figure 28. Typical diode forward voltage as a function of junction temperature**

### PG-TO263-3

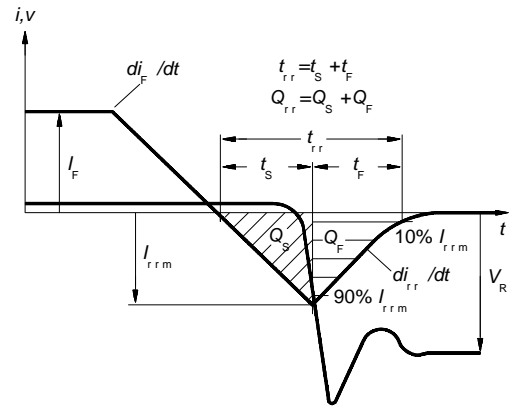


DIM	MILLIMETERS		INCHES	
	MIN	MAX	MIN	MAX
A	4.30	4.57	0.169	0.180
A1	0.00	0.25	0.000	0.010
b	0.65	0.85	0.026	0.033
b2	0.95	1.15	0.037	0.045
c	0.33	0.65	0.013	0.026
c2	1.17	1.40	0.046	0.055
D	8.51	9.45	0.335	0.372
D1	7.10	7.90	0.280	0.311
E	9.80	10.31	0.386	0.406
E1	6.50	8.60	0.256	0.339
e	2.54		0.100	
e1	5.08		0.200	
N	2		2	
H	14.61	15.88	0.575	0.625
L	2.29	3.00	0.090	0.118
L1	0.70	1.60	0.028	0.063
L2	1.00	1.78	0.039	0.070
F1	16.05	16.25	0.632	0.640
F2	9.30	9.50	0.366	0.374
F3	4.50	4.70	0.177	0.185
F4	10.70	10.90	0.421	0.429
F5	3.65	3.85	0.144	0.152
F6	1.25	1.45	0.049	0.057

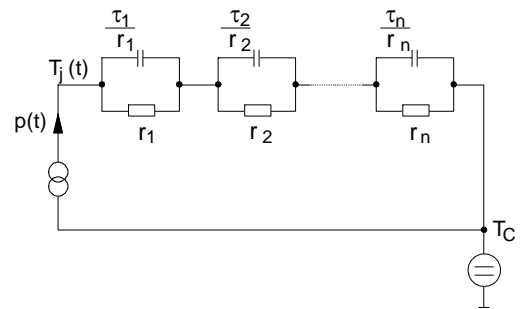
DOCUMENT NO. Z8B00003324
SCALE 
EUROPEAN PROJECTION 
ISSUE DATE 30-08-2007
REVISION 01



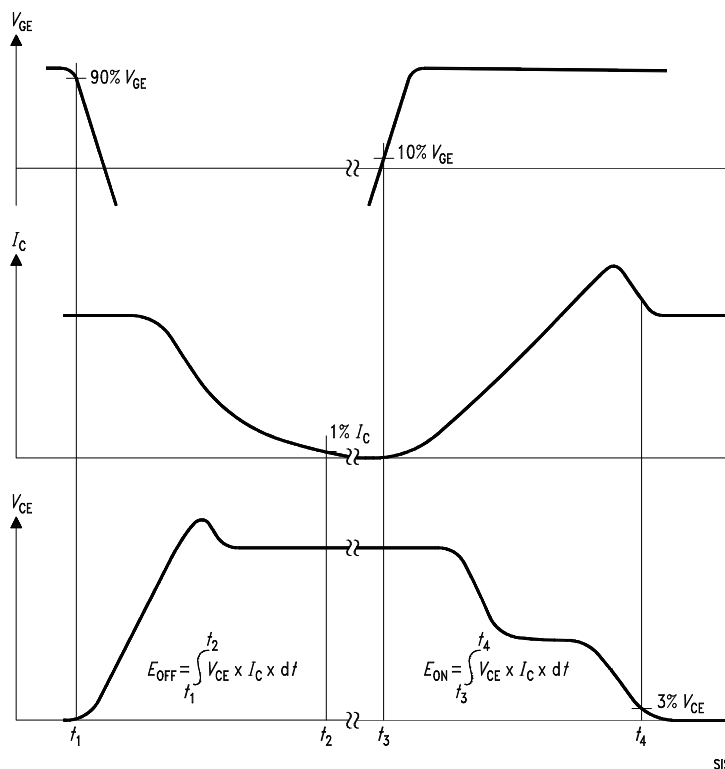
**Figure A. Definition of switching times**



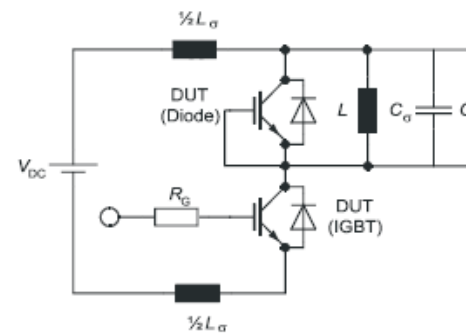
**Figure C. Definition of diodes switching characteristics**



**Figure D. Thermal equivalent circuit**



**Figure B. Definition of switching losses**



**Figure E. Dynamic test circuit**  
Parasitic inductance  $L_{\sigma}$ ,  
Parasitic capacitor  $C_{\sigma}$ ,  
Relief capacitor  $C_r$   
(only for ZVT switching)

**Published by**  
**Infineon Technologies AG**  
**81726 Munich, Germany**  
**© 2013 Infineon Technologies AG**  
**All Rights Reserved.**

### **Legal Disclaimer**

The information given in this document shall in no event be regarded as a guarantee of conditions or characteristics. With respect to any examples or hints given herein, any typical values stated herein and/or any information regarding the application of the device, Infineon Technologies hereby disclaims any and all warranties and liabilities of any kind, including without limitation, warranties of non-infringement of intellectual property rights of any third party.

### **Information**

For further information on technology, delivery terms and conditions and prices, please contact the nearest Infineon Technologies Office ([www.infineon.com](http://www.infineon.com)).

### **Warnings**

Due to technical requirements, components may contain dangerous substances. For information on the types in question, please contact the nearest Infineon Technologies Office.

The Infineon Technologies component described in this Data Sheet may be used in life-support devices or systems and/or automotive, aviation and aerospace applications or systems only with the express written approval of Infineon Technologies, if a failure of such components can reasonably be expected to cause the failure of that life-support, automotive, aviation and aerospace device or system or to affect the safety or effectiveness of that device or system. Life support devices or systems are intended to be implanted in the human body or to support and/or maintain and sustain and/or protect human life. If they fail, it is reasonable to assume that the health of the user or other persons may be endangered.