

HighSpeed 2-Technology

- **Designed for:**
 - SMPS
 - Lamp Ballast
 - ZVS-Converter
 - optimised for soft-switching / resonant topologies
- **2nd generation HighSpeed-Technology for 1200V applications offers:**
 - loss reduction in resonant circuits
 - temperature stable behavior
 - parallel switching capability
 - tight parameter distribution
 - E_{off} optimized for $I_C = 3A$
- Qualified according to JEDEC² for target applications
- Pb-free lead plating; RoHS compliant
- Complete product spectrum and PSpice Models : <http://www.infineon.com/igbt/>

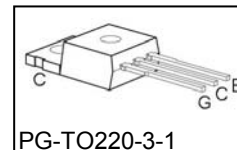
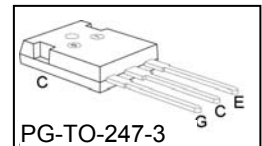
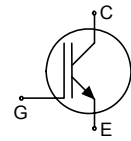

Type	V_{CE}	I_C	E_{off}	T_j	Marking	Package
IGW03N120H2	1200V	3A	0.15mJ	150°C	G03H1202	PG-TO-247-3
IGP03N120H2	1200V	3A	0.15mJ	150°C	G03H1202	PG-TO-220-3-1

Maximum Ratings

Parameter	Symbol	Value	Unit
Collector-emitter voltage	V_{CE}	1200	V
Triangular collector current	I_C	9.6 3.9	A
$T_C = 25^\circ\text{C}, f = 140\text{kHz}$			
$T_C = 100^\circ\text{C}, f = 140\text{kHz}$			
Pulsed collector current, t_p limited by T_{jmax}	I_{Cpuls}	9.9	
Turn off safe operating area	-	9.9	
$V_{CE} \leq 1200\text{V}, T_j \leq 150^\circ\text{C}$			
Gate-emitter voltage	V_{GE}	± 20	V
Power dissipation	P_{tot}	62.5	W
$T_C = 25^\circ\text{C}$			
Operating junction and storage temperature	T_j, T_{stg}	-40...+150	°C
Soldering temperature, 1.6mm (0.063 in.) from case for 10s	-	260	

² J-STD-020 and JESD-022

Thermal Resistance

Parameter	Symbol	Conditions	Max. Value	Unit
Characteristic				
IGBT thermal resistance, junction – case	R_{thJC}		2.0	K/W
Thermal resistance, junction – ambient	R_{thJA}	PG-TO-220-3-1 PG-TO-247-3	62 40	

Electrical Characteristic, at $T_j = 25\text{ }^\circ\text{C}$, unless otherwise specified

Parameter	Symbol	Conditions	Value			Unit
			min.	Typ.	max.	
Static Characteristic						
Collector-emitter breakdown voltage	$V_{(BR)CES}$	$V_{GE}=0V, I_C=300\mu A$	1200	-	-	V
Collector-emitter saturation voltage	$V_{CE(sat)}$	$V_{GE} = 15V, I_C=3A$ $T_j=25^\circ C$ $T_j=150^\circ C$ $V_{GE} = 10V, I_C=3A,$ $T_j=25^\circ C$	- - -	2.2 2.5 2.4	2.8 - -	
Gate-emitter threshold voltage	$V_{GE(th)}$	$I_C=90\mu A, V_{CE}=V_{GE}$	2.1	3	3.9	
Zero gate voltage collector current	I_{CES}	$V_{CE}=1200V, V_{GE}=0V$ $T_j=25^\circ C$ $T_j=150^\circ C$	- -	- -	20 80	μA
Gate-emitter leakage current	I_{GES}	$V_{CE}=0V, V_{GE}=20V$	-	-	100	nA
Transconductance	g_{fs}	$V_{CE}=20V, I_C=3A$	-	2	-	S
Dynamic Characteristic						
Input capacitance	C_{iss}	$V_{CE}=25V,$ $V_{GE}=0V,$ $f=1MHz$	-	205	-	pF
Output capacitance	C_{oss}		-	24	-	
Reverse transfer capacitance	C_{riss}		-	7	-	
Gate charge	Q_{Gate}	$V_{CC}=960V, I_C=3A$ $V_{GE}=15V$	-	22	-	nC
Internal emitter inductance measured 5mm (0.197 in.) from case	L_E	PG-TO-220-3-1 PG-TO-247-3	- -	7 13	- -	nH

Switching Characteristic, Inductive Load, at $T_j=25^\circ\text{C}$

Parameter	Symbol	Conditions	Value			Unit
			min.	typ.	max.	
IGBT Characteristic						
Turn-on delay time	$t_{d(on)}$	$T_j=25^\circ\text{C}$, $V_{CC}=800\text{V}$, $I_C=3\text{A}$, $V_{GE}=15\text{V}/0\text{V}$, $R_G=82\Omega$, $L_\sigma^{2)}=180\text{nH}$, $C_\sigma^{2)}=40\text{pF}$ Energy losses include "tail" and diode ³⁾ reverse recovery.	-	9.2	-	ns
Rise time	t_r		-	5.2	-	
Turn-off delay time	$t_{d(off)}$		-	281	-	
Fall time	t_f		-	29	-	
Turn-on energy	E_{on}		-	0.14	-	mJ
Turn-off energy	E_{off}		-	0.15	-	
Total switching energy	E_{ts}		-	0.29	-	

Switching Characteristic, Inductive Load, at $T_j=150^\circ\text{C}$

Parameter	Symbol	Conditions	Value			Unit
			min.	typ.	max.	
IGBT Characteristic						
Turn-on delay time	$t_{d(on)}$	$T_j=150^\circ\text{C}$ $V_{CC}=800\text{V}$, $I_C=3\text{A}$, $V_{GE}=15\text{V}/0\text{V}$, $R_G=82\Omega$, $L_\sigma^{2)}=180\text{nH}$, $C_\sigma^{2)}=40\text{pF}$ Energy losses include "tail" and diode ³⁾ reverse recovery.	-	9.4	-	ns
Rise time	t_r		-	6.7	-	
Turn-off delay time	$t_{d(off)}$		-	340	-	
Fall time	t_f		-	63	-	
Turn-on energy	E_{on}		-	0.22	-	mJ
Turn-off energy	E_{off}		-	0.26	-	
Total switching energy	E_{ts}		-	0.48	-	

Switching Energy ZVT, Inductive Load

Parameter	Symbol	Conditions	Value			Unit
			min.	typ.	max.	
IGBT Characteristic						
Turn-off energy	E_{off}	$V_{CC}=800\text{V}$, $I_C=3\text{A}$, $V_{GE}=15\text{V}/0\text{V}$, $R_G=82\Omega$, $C_r^{2)}=4\text{nF}$ $T_j=25^\circ\text{C}$ $T_j=150^\circ\text{C}$	-	0.05	-	mJ
			-	0.09	-	

²⁾ Leakage inductance L_σ and stray capacity C_σ due to dynamic test circuit in figure E

³⁾ Commutation diode from device IKP03N120H2

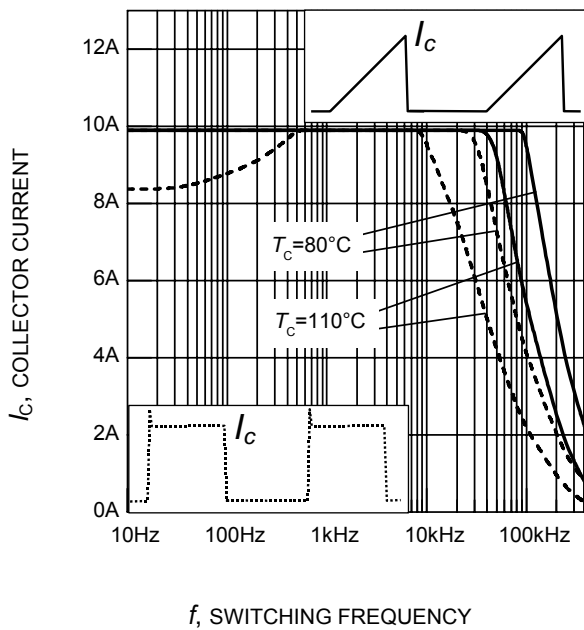

Figure 1. Collector current as a function of switching frequency
($T_j \leq 150^\circ\text{C}$, $D = 0.5$, $V_{CE} = 800\text{V}$, $V_{GE} = +15\text{V}/0\text{V}$, $R_G = 82\Omega$)

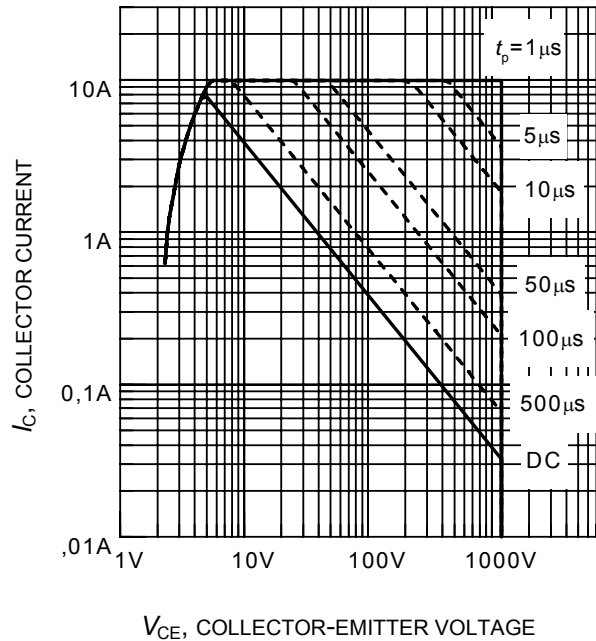

Figure 2. Safe operating area
($D = 0$, $T_C = 25^\circ\text{C}$, $T_j \leq 150^\circ\text{C}$)

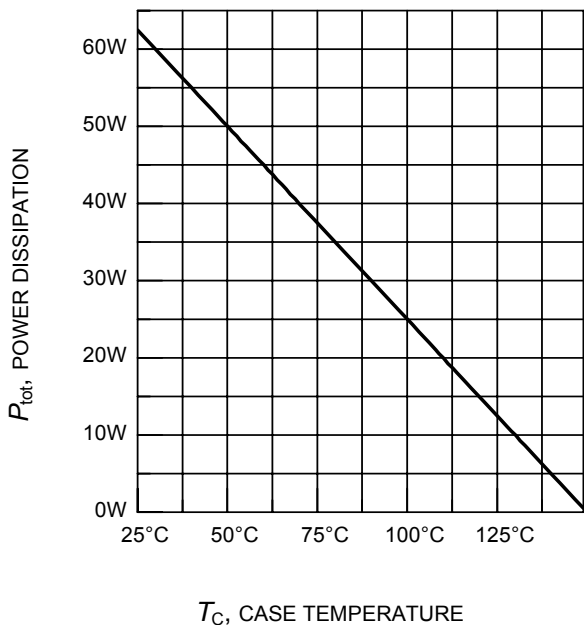

Figure 3. Power dissipation as a function of case temperature
($T_j \leq 150^\circ\text{C}$)

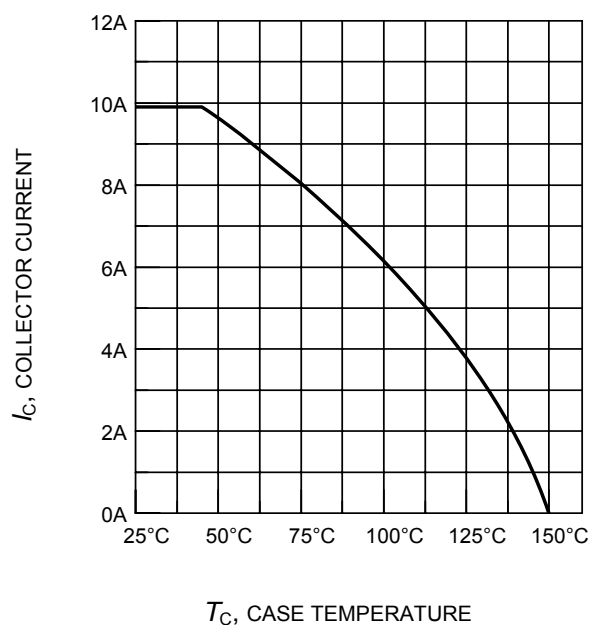
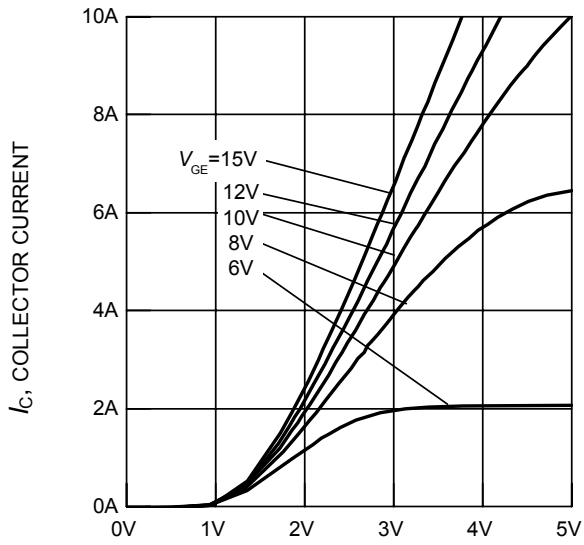
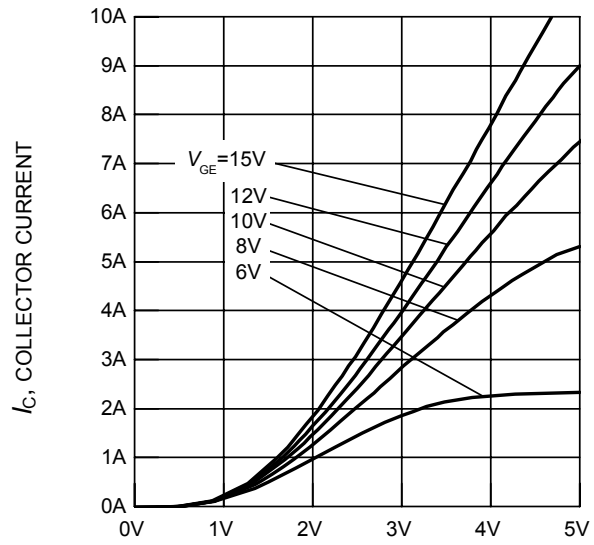

Figure 4. Collector current as a function of case temperature
($V_{GE} \leq 15\text{V}$, $T_j \leq 150^\circ\text{C}$)



V_{CE} , COLLECTOR-EMITTER VOLTAGE

Figure 5. Typical output characteristics
($T_j = 25^\circ\text{C}$)



V_{CE} , COLLECTOR-EMITTER VOLTAGE

Figure 6. Typical output characteristics
($T_j = 150^\circ\text{C}$)

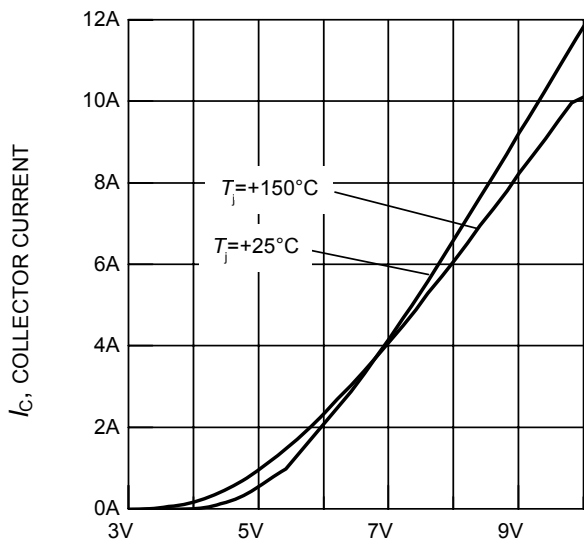

V_{GE} , GATE-EMITTER VOLTAGE

Figure 7. Typical transfer characteristics
($V_{CE} = 20\text{V}$)

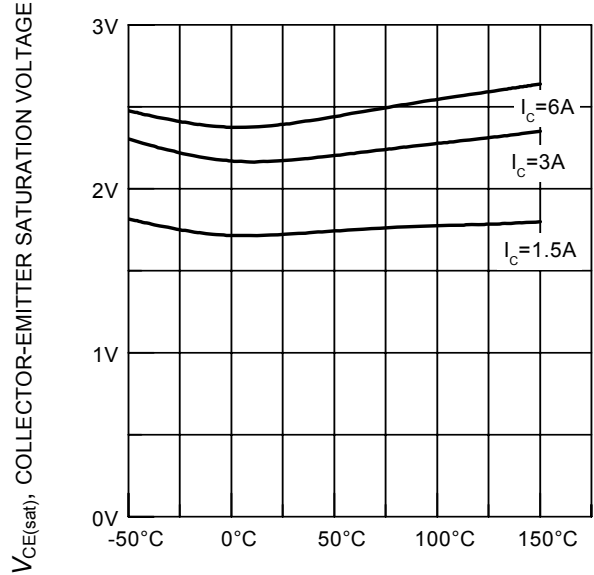

T_j , JUNCTION TEMPERATURE

Figure 8. Typical collector-emitter saturation voltage as a function of junction temperature
($V_{GE} = 15\text{V}$)

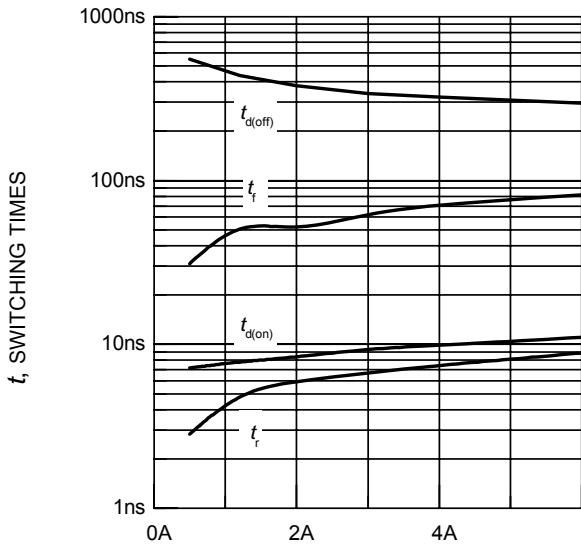

I_C , COLLECTOR CURRENT

Figure 9. Typical switching times as a function of collector current

(inductive load, $T_j = 150^\circ\text{C}$,
 $V_{CE} = 800\text{V}$, $V_{GE} = +15\text{V}/0\text{V}$, $R_G = 82\Omega$,
dynamic test circuit in Fig.E)

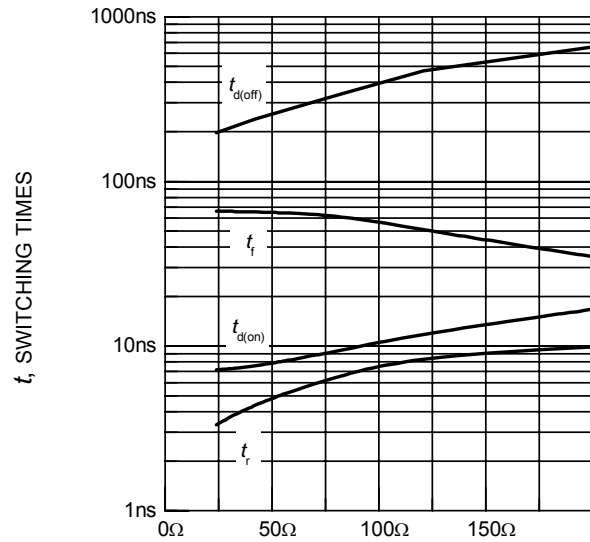

R_G , GATE RESISTOR

Figure 10. Typical switching times as a function of gate resistor

(inductive load, $T_j = 150^\circ\text{C}$,
 $V_{CE} = 800\text{V}$, $V_{GE} = +15\text{V}/0\text{V}$, $I_C = 3\text{A}$,
dynamic test circuit in Fig.E)

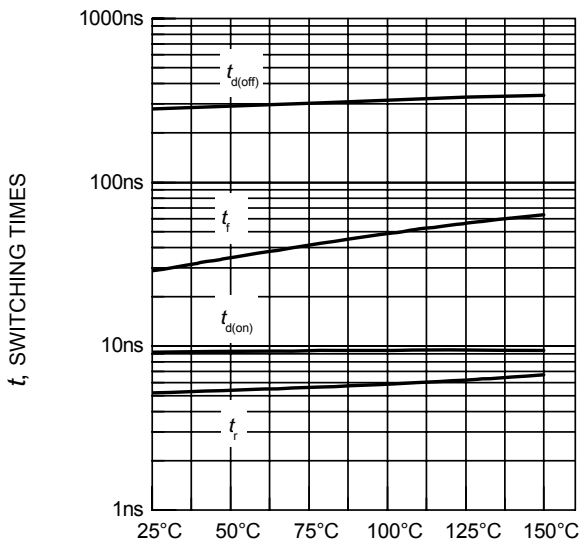

T_j , JUNCTION TEMPERATURE

Figure 11. Typical switching times as a function of junction temperature

(inductive load, $V_{CE} = 800\text{V}$,
 $V_{GE} = +15\text{V}/0\text{V}$, $I_C = 3\text{A}$, $R_G = 82\Omega$,
dynamic test circuit in Fig.E)

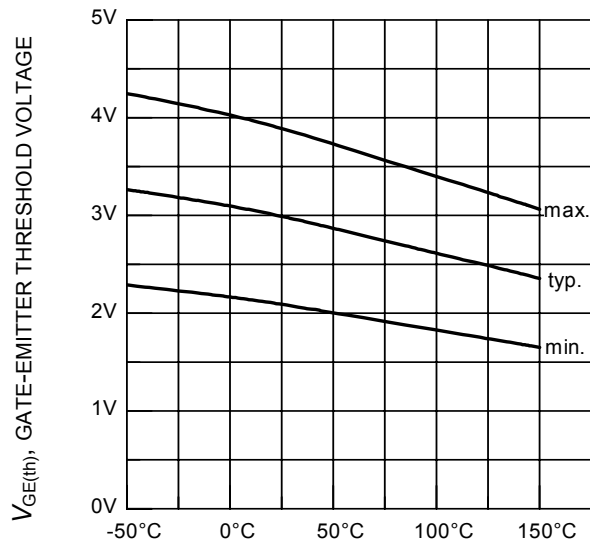

T_j , JUNCTION TEMPERATURE

Figure 12. Gate-emitter threshold voltage as a function of junction temperature

($I_C = 0.09\text{mA}$)

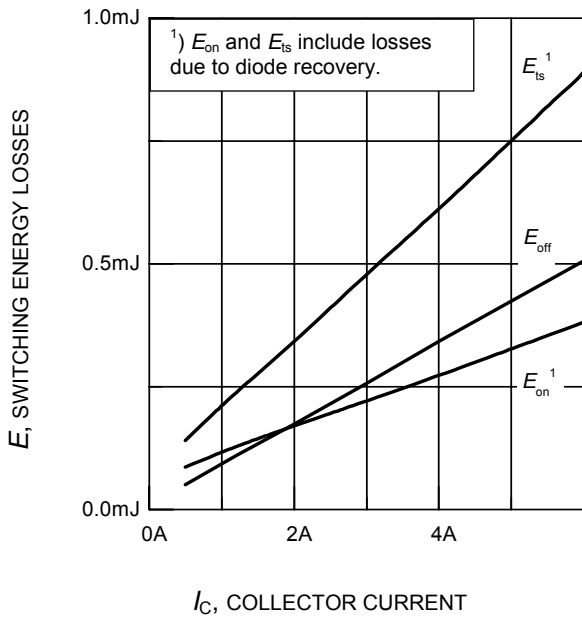

Figure 13. Typical switching energy losses as a function of collector current
(inductive load, $T_j = 150^\circ\text{C}$, $V_{CE} = 800\text{V}$, $V_{GE} = +15\text{V}/0\text{V}$, $R_G = 82\Omega$, dynamic test circuit in Fig.E)

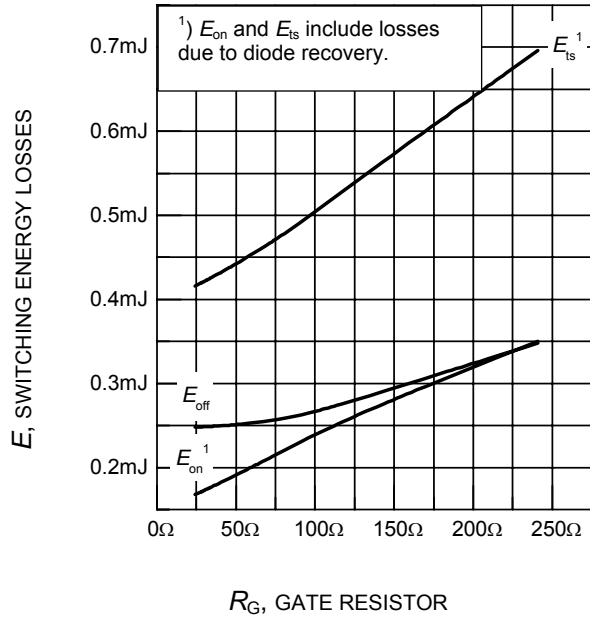

Figure 14. Typical switching energy losses as a function of gate resistor
(inductive load, $T_j = 150^\circ\text{C}$, $V_{CE} = 800\text{V}$, $V_{GE} = +15\text{V}/0\text{V}$, $I_C = 3\text{A}$, dynamic test circuit in Fig.E)

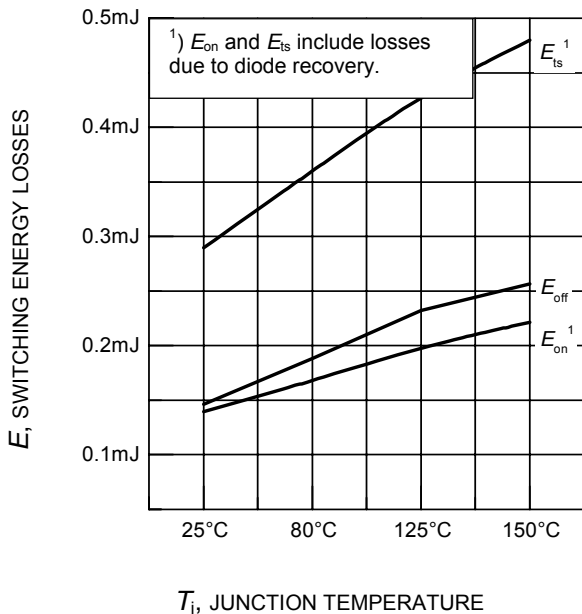

Figure 15. Typical switching energy losses as a function of junction temperature
(inductive load, $V_{CE} = 800\text{V}$, $V_{GE} = +15\text{V}/0\text{V}$, $I_C = 3\text{A}$, $R_G = 82\Omega$, dynamic test circuit in Fig.E)

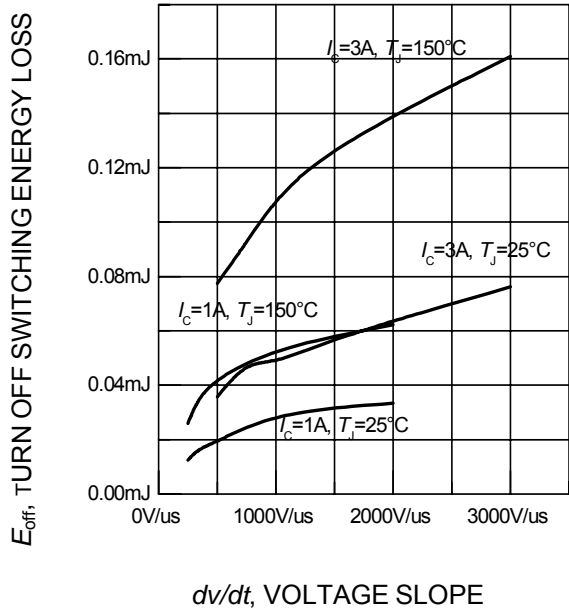

Figure 16. Typical turn off switching energy loss for soft switching
(dynamic test circuit in Fig. E)

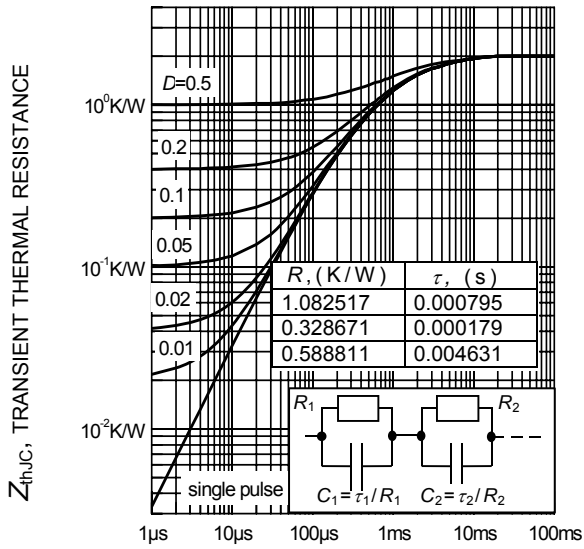

Figure 16. IGBT transient thermal resistance
($D = t_p / T$)

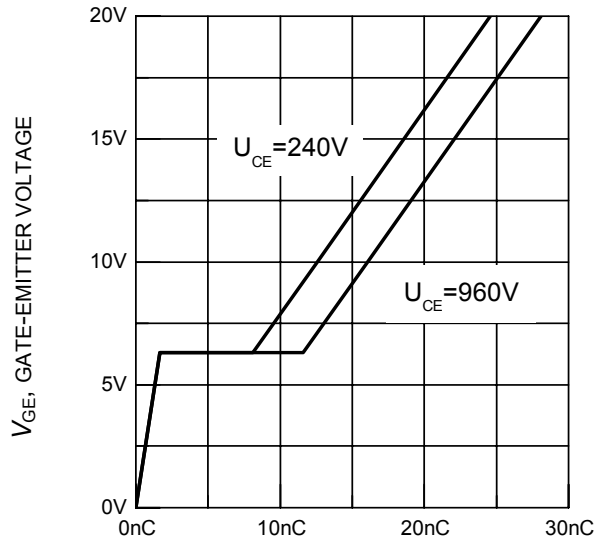

Figure 17. Typical gate charge
($I_C = 3A$)

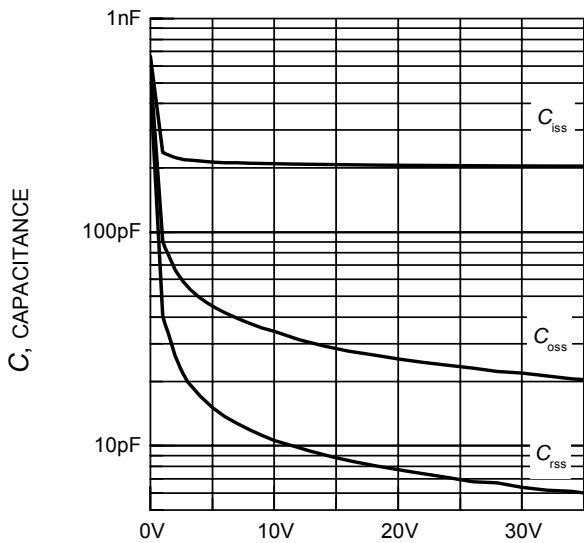

Figure 18. Typical capacitance as a function of collector-emitter voltage
($V_{GE} = 0V$, $f = 1MHz$)

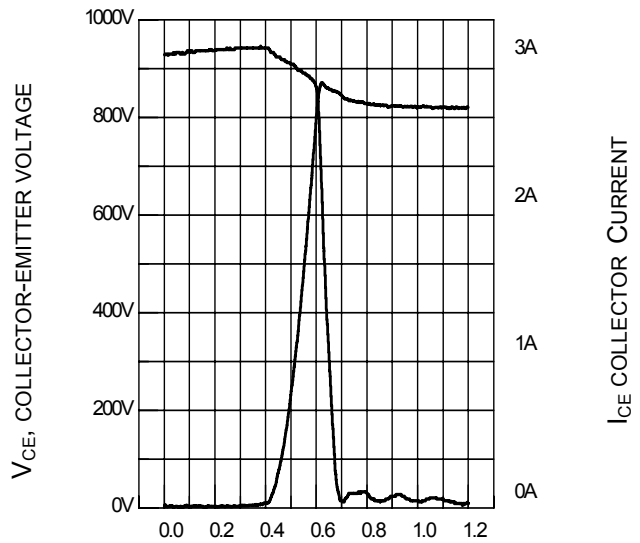

Figure 20. Typical turn off behavior, hard switching
($V_{GE} = 15/0V$, $R_G = 82\Omega$, $T_j = 150^\circ C$,
Dynamic test circuit in Figure E)

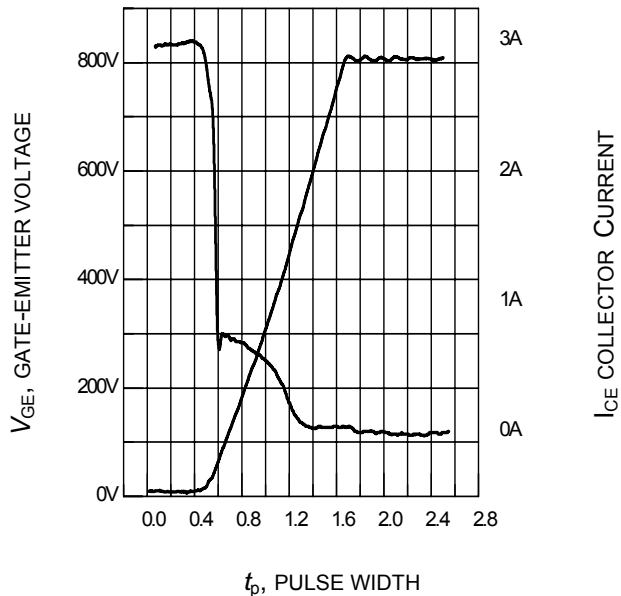
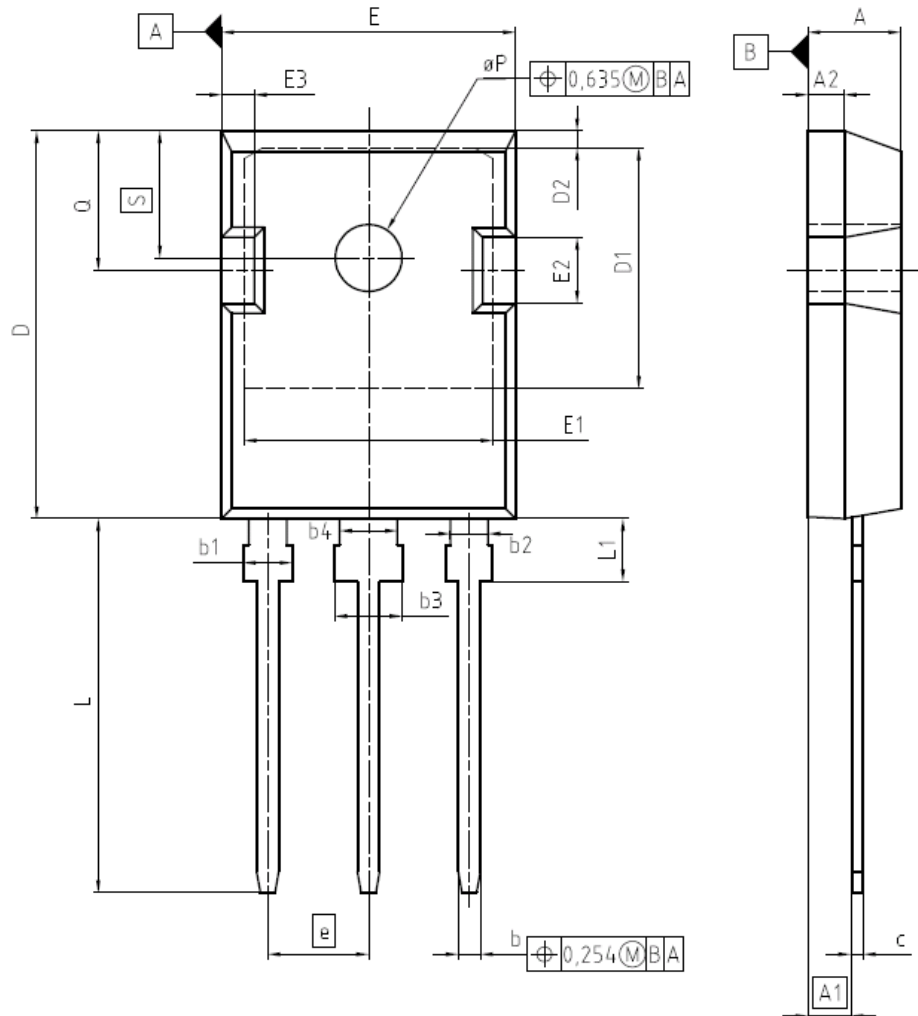

Figure 21. Typical turn off behavior, soft switching

($V_{GE}=15/0V$, $R_G=82\Omega$, $T_j = 150^\circ C$,
Dynamic test circuit in Figure E)

PG-TO247-3



DIM	MILLIMETERS		INCHES	
	MIN	MAX	MIN	MAX
A	4,90	5,16	0,193	0,203
A1	2,27	2,53	0,089	0,099
A2	1,85	2,11	0,073	0,083
b	1,07	1,33	0,042	0,052
b1	1,90	2,41	0,075	0,095
b2	1,90	2,16	0,075	0,085
b3	2,87	3,38	0,113	0,133
b4	2,87	3,13	0,113	0,123
c	0,55	0,68	0,022	0,027
D	20,82	21,10	0,820	0,831
D1	16,25	17,65	0,640	0,695
D2	1,05	1,35	0,041	0,053
E	15,70	16,03	0,618	0,631
E1	13,10	14,15	0,516	0,557
E2	3,68	5,10	0,145	0,201
E3	1,68	2,60	0,066	0,102
e	5,44		0,214	
N	3		3	
L	19,80	20,31	0,780	0,799
L1	4,17	4,47	0,164	0,176
ϕP	3,50	3,70	0,138	0,146
Q	5,49	6,00	0,216	0,236
S	6,04	6,30	0,238	0,248

DOCUMENT NO.
Z8B00003327

SCALE
0 5 5 7,5mm

EUROPEAN PROJECTION

ISSUE DATE
17-12-2007

REVISION
03

PG-TO220-3-1

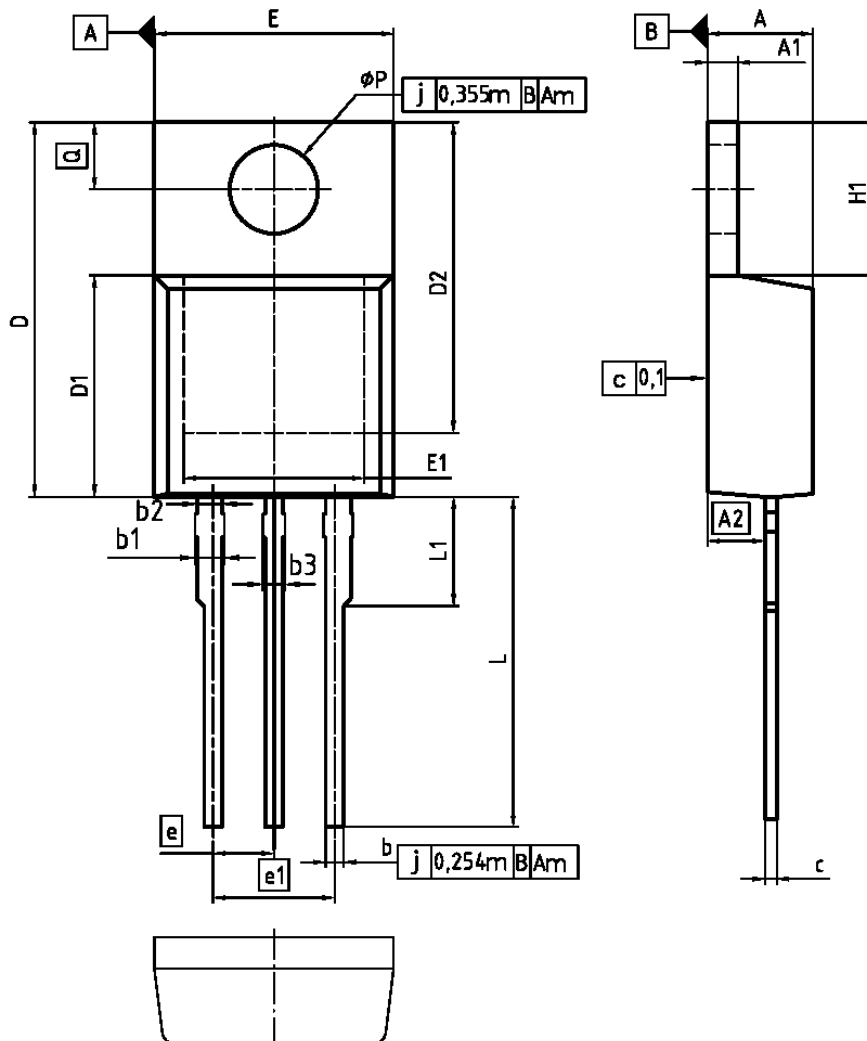

DIM	MILLIMETERS		INCHES	
	MIN	MAX	MIN	MAX
A	4.30	4.57	0.169	0.180
A1	1.17	1.40	0.046	0.055
A2	2.15	2.72	0.085	0.107
b	0.65	0.86	0.026	0.034
b1	0.95	1.40	0.037	0.055
b2	0.95	1.15	0.037	0.045
b3	0.85	1.15	0.028	0.045
c	0.33	0.80	0.013	0.024
D	14.81	15.95	0.583	0.628
D1	8.51	9.45	0.335	0.372
D2	12.19	13.10	0.480	0.518
E	9.70	10.36	0.382	0.408
E1	6.50	8.60	0.256	0.339
e	2.54		0.100	
e1	5.08		0.200	
N	3		3	
H1	5.90	6.90	0.232	0.272
L	13.00	14.00	0.512	0.551
L1	-	4.80	-	0.189
øP	3.60	3.89	0.142	0.153
Q	2.60	3.00	0.102	0.118

DOCUMENT NO.
Z8B00003318

SCALE

EUROPEAN PROJECTION

ISSUE DATE
23-08-2007

REVISION
05

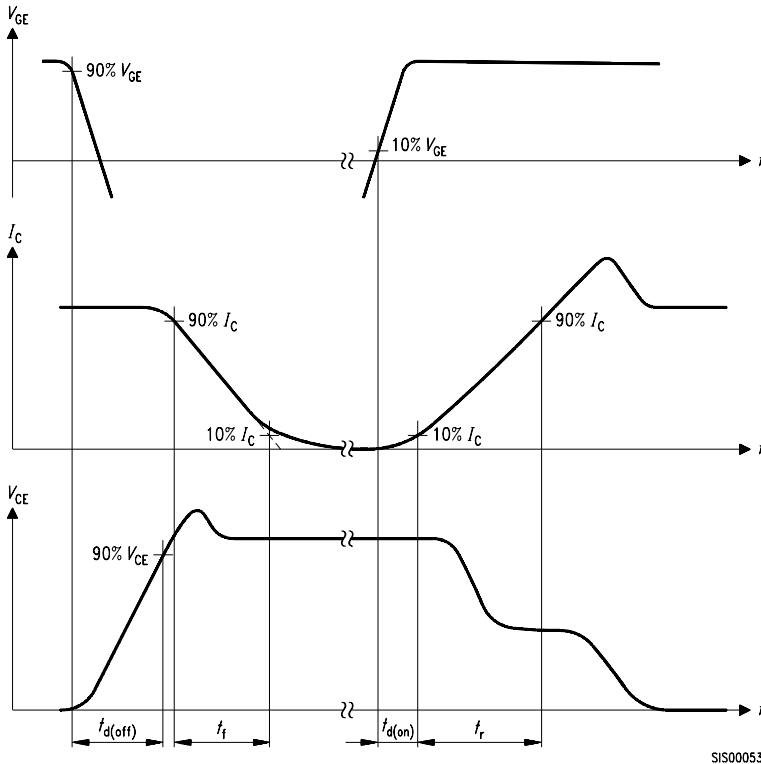

Figure A. Definition of switching times

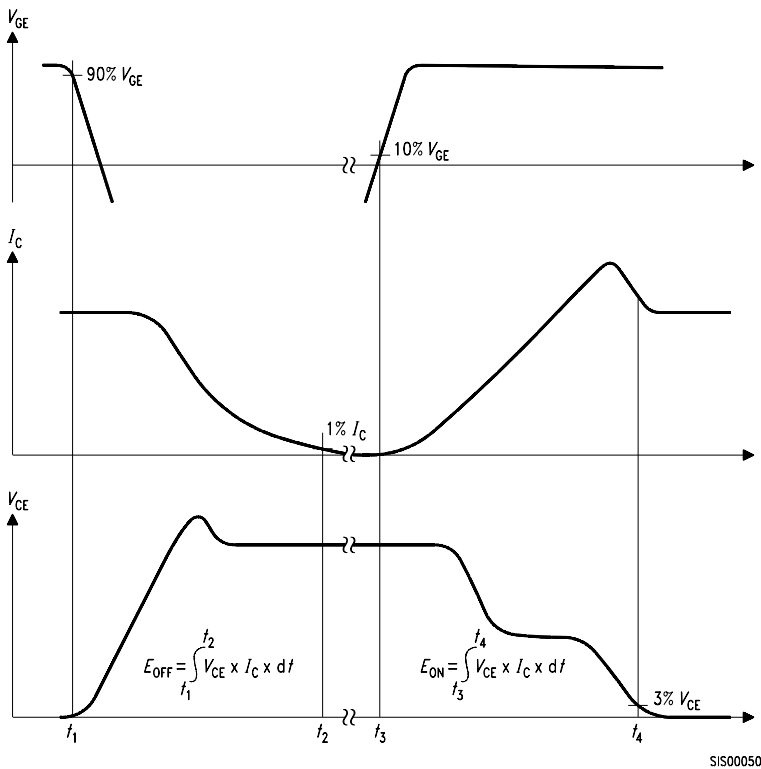

Figure B. Definition of switching losses

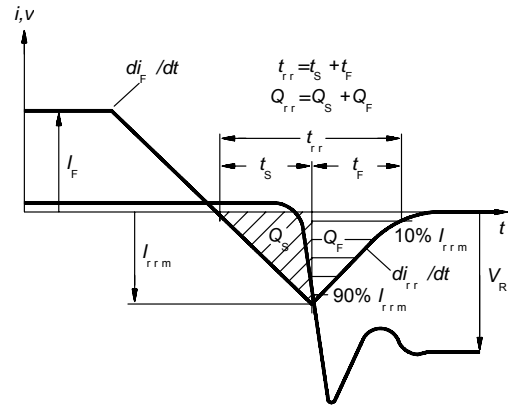

Figure C. Definition of diodes switching characteristics

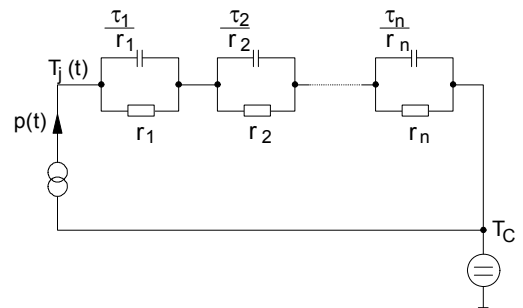

Figure D. Thermal equivalent circuit

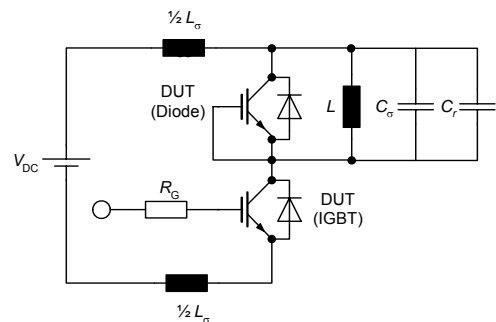

Figure E. Dynamic test circuit
Leakage inductance $L_\sigma = 180\text{nH}$,
Stray capacitor $C_\sigma = 40\text{pF}$,
Relief capacitor $C_r = 4\text{nF}$ (only for ZVT switching)

Edition 2006-01

Published by
Infineon Technologies AG
81726 München, Germany

© Infineon Technologies AG 2/18/08.

All Rights Reserved.

Attention please!

The information given in this data sheet shall in no event be regarded as a guarantee of conditions or characteristics ("Beschaffenheitsgarantie"). With respect to any examples or hints given herein, any typical values stated herein and/or any information regarding the application of the device, Infineon Technologies hereby disclaims any and all warranties and liabilities of any kind, including without limitation warranties of non-infringement of intellectual property rights of any third party.

Information

For further information on technology, delivery terms and conditions and prices please contact your nearest Infineon Technologies Office (www.infineon.com).

Warnings

Due to technical requirements components may contain dangerous substances. For information on the types in question please contact your nearest Infineon Technologies Office.

Infineon Technologies Components may only be used in life-support devices or systems with the express written approval of Infineon Technologies, if a failure of such components can reasonably be expected to cause the failure of that life-support device or system, or to affect the safety or effectiveness of that device or system. Life support devices or systems are intended to be implanted in the human body, or to support and/or maintain and sustain and/or protect human life. If they fail, it is reasonable to assume that the health of the user or other persons may be endangered.