

Avionics

IFR 6015 Ramp Test Set



The IFR 6015 is a compact, lightweight and weatherproof unit designed for testing transponder modes A/C/S, TCAS I, II and Military E-TCAS as well as DME.

- One main user screen for each test mode
- Detachable antenna
- Large display
- Simple user interface
- Lightweight and compact <8 lbs. (3.6 kg)
- Battery 6 hours plus duration
- Fully FAR part 43 appendix F compliant
- European Elementary and Enhanced Surveillance

The IFR 6015 features an extremely easy to use interface where every parameter the user commonly needs to view is displayed on screen.

Controls

Dedicated Mode keys for XPDR, DME and TCAS allow quick selection of the operational mode.

The application dependant softkeys and data select/slew keys provide an intuitive man machine interface.

DME mode is provided with dedicated keys for frequency/channel selection and RF level control. For frequently varied parameters in DME and TCAS modes, such as Range and Rate, dedicated keys are provided.



Operational Modes

Each operational mode has one main user screen. The operational modes are:

XPDR (Sub-Modes: ADS-B MON, ADS-B GEN & GICB)

DME

TCAS 1, 2 (Sub-Modes: TIS & TIS-B)

E-TCAS

Most tests can be completed without leaving the main user screens. This simplifies the line technician's testing task.

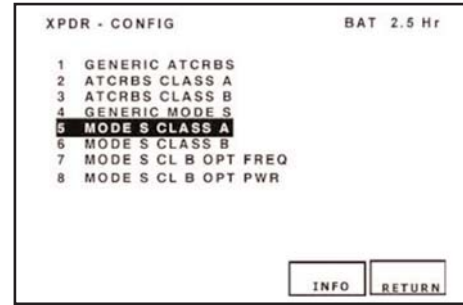
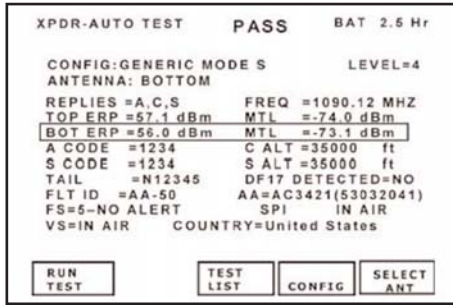

Mode S and ATCRBS Transponder

Xpdr Auto-Test:

Every parameter the user commonly needs to view is displayed on one screen.

The auto-test performs all tests defined by FAR Part 43 Appendix F, including the proposed Eurocontrol additional tests.

The tests are tailored automatically according to reported transponder level to avoid erroneous failures.

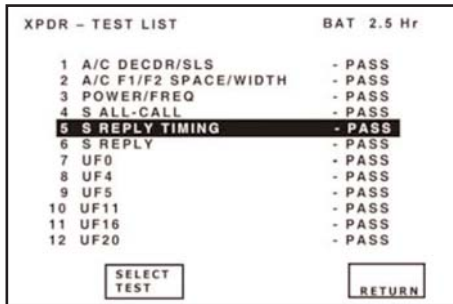

The test list is selected from the auto-test screen. This provides an easy means of selecting any of the individual tests that comprise the auto-test.

Tests on the 2nd screen (not shown) include:

- 13 UF21
- 14 UF24
- 15 ELEMENTARY SURVEILLANCE 1
- 16 ELEMENTARY SURVEILLANCE 2
- 15 ENHANCED SURVEILLANCE

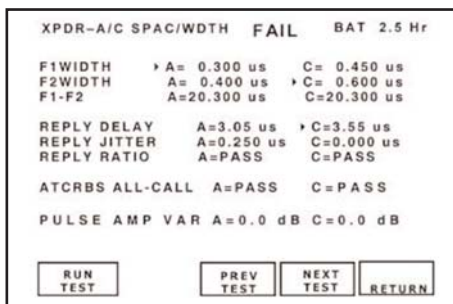

Individual tests may be reviewed for failures which are identified by an arrow symbol.

User selects config required for test.

If the class of the transponder is unknown, the generic config may be selected which applies to the widest limits.

The test set will automatically determine the Mode S transponder level.

The selected config parameters may be displayed by pressing the INFO softkey.

Eight predetermined configs are provided to meet the currently fielded transponder test needs.

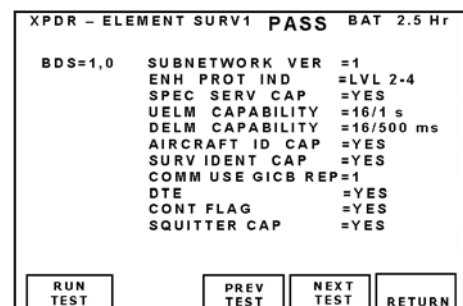
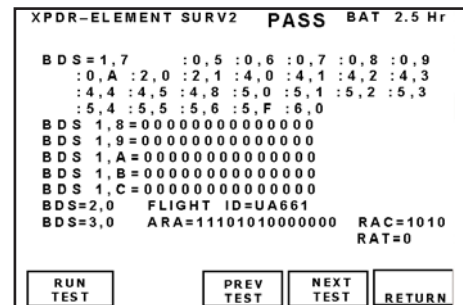

The Eurocontrol Elementary Surveillance DAP's (Downlink Aircraft Parameters) are displayed on two screens

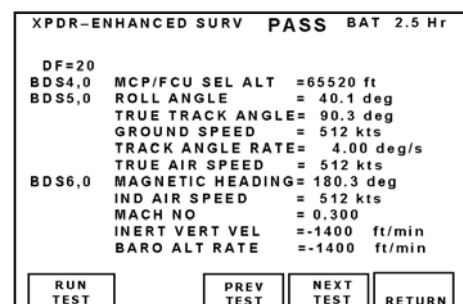

Eurocontrol Enhanced Surveillance DAP's are displayed on one screen.

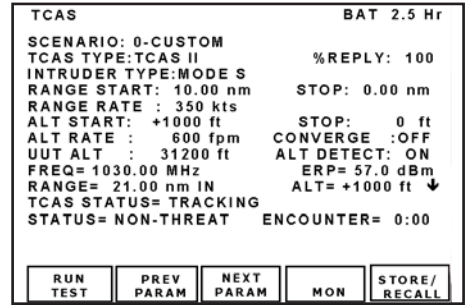
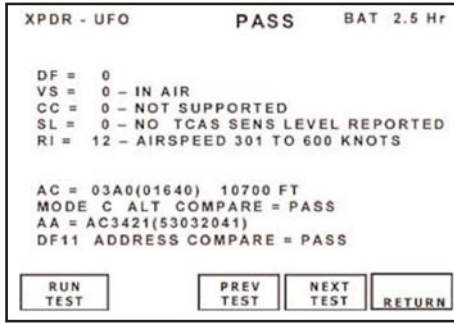

No more HEX data field interpretation!

All Mode S Format tests display parameter in engineering units.

TCAS

TCAS types...

TCAS 1 MODE C

TCAS 2 ATCRBS

TCAS 2 MODE S

E-TCAS

The Auto-Altitude feature interrogates Mode S XPDR of A/C under test to obtain current altitude.

Select pre-stored scenarios directly from the auto-test screen.

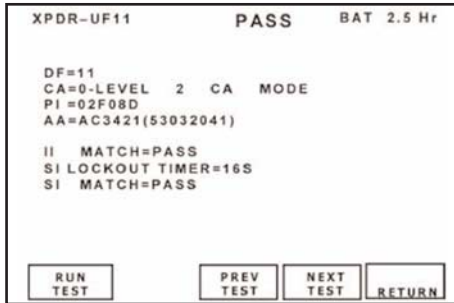

Comprehensive II / SI code and lockout timer test

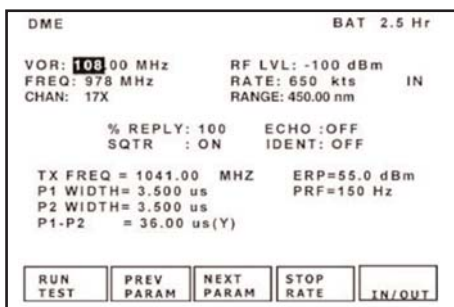
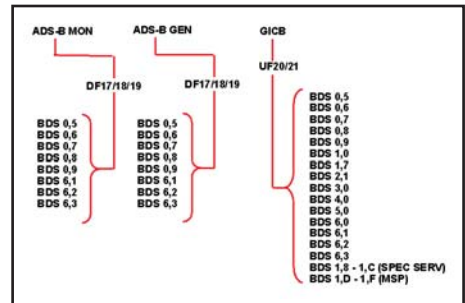
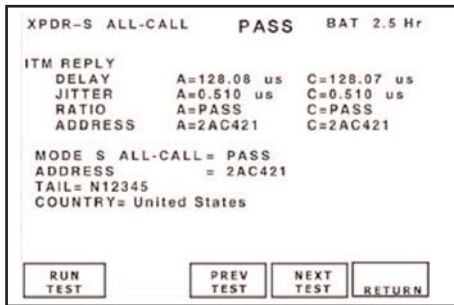
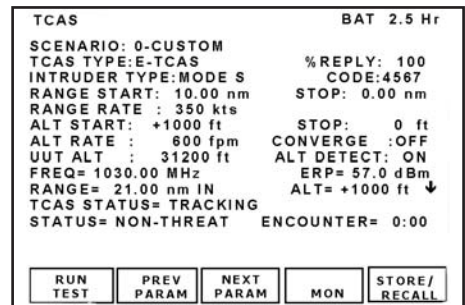

ADS-B and GICB

ADS-B MON: Used to monitor DF17 extended squitter from transponders and DF18 extended squitter from 1090 MHz ADS-B emitters.

ADS-B GEN: Used to generate DF17/DF18 extended squitter, simulating transponders and 1090 MHz ADS-B emitters.

GICB: Used to monitor DAP's (all fields).

DME

All the user needs are on one screen.

- RF level control for track sensitivity tests
- Supports all DME/TACAN channels selectable in VOR paired channels
- Full UUT measured parameters are displayed.

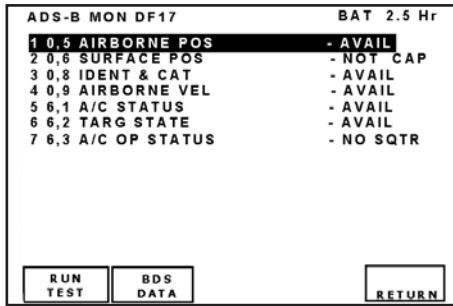

ADS-B MON:

The ADS-B MON LIST shows BDS formats supported.

The BDS status is annunciated to indicate if the squitter has been captured, not available or not seen.

The BDS DATA key displays the BDS DATA screen for the selected BDS number.

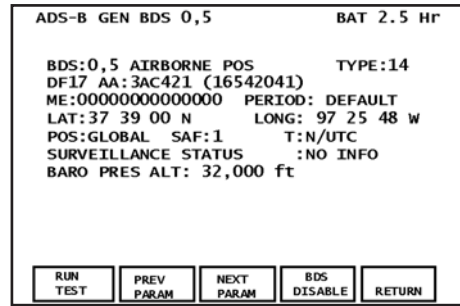

ADS-B GEN:

BDS DATA screens display full content of the selected BDS format in RTCA/ICAO engineering units.

The NEXT & PREV PARAM keys select data fields for editing via the data slew keys.

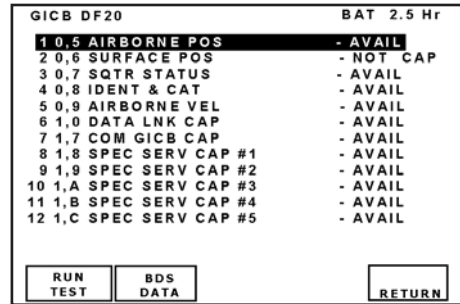
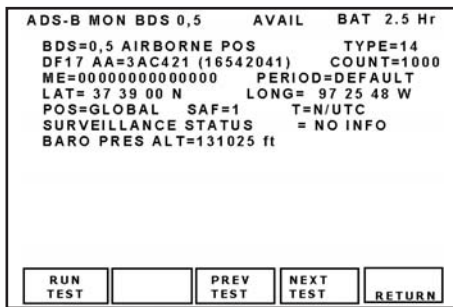

GICB:

The BDS LIST shows BDS formats supported.

The BDS DATA key displays the BDS DATA screen for the selected BDS number.

ADS-B MON:

The BDS DATA screen displays full content of selected BDS format being received via DF17, DF18 or DF19 extended squitters.

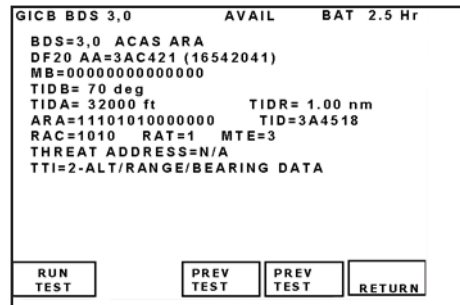
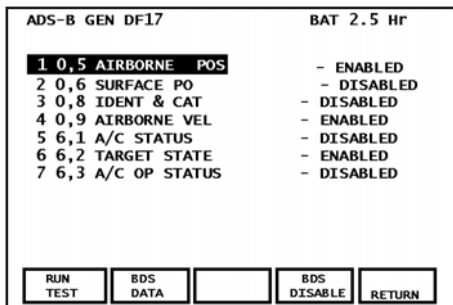

ADS-B GEN:

The BDS LIST shows BDS formats supported. The BDS SELECT key selects individual BDS numbers. The BDS ENABLE/DISABLE key enables or disables the selected BDS number for squittering via DF17 or DF18 extended squitter. The BDS DATA key displays the BDS DATA screen for the selected BDS number.

GICB:

BDS DATA screens display full content of the selected BDS format being received via GICB DF20 or DF21 in RTCA/ICAO engineering units.

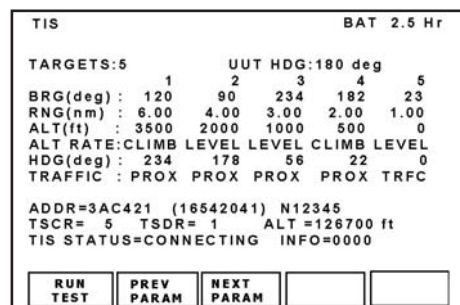

TIS

Up to 5 static intruders may be simulated relative to the A/C (UUT).

TIS-B		BAT 2.5 Hr	
TARGETS:5			
UUT LAT:37 39 00 N		UUT HDG:180 deg	
LONG: 97 25 48 W			
BRG(deg) :	1 2 3 4 5		
120 90 234 182 23			
RNG(nm) :	6.00 4.00 3.00 2.00 1.00		
ALT(ft) :	3500 2000 1000 500 0		
ALT RATE:CLIMB LEVEL LEVEL CLIMB LEVEL			
HDG(deg) :	234 178 56 22 0		
ADDR=3AC421 (16542041) N12345			
DF18 PERIOD= 10 S	ALT =126700 ft		
ERP =57.0 dBm	FREQ=1090.00 MHz		
RUN TEST	PREV PARAM	NEXT PARAM	

TIS-B:

The user enters the A/C (UUT) LAT/LONG and heading.

Up to 5 static intruders may be simulated relative to the A/C (UUT).

General

Radiated Testing:

The IFR 6015 is supplied with a lightweight fully sealed directional antenna that may be test set mounted, hand held or tripod mounted.

Direct Connect Testing:

The IFR 6015 may be directly connected to the UUT via a supplied RF coax cable via the RF I/O port.



Transit Case:

The IFR 6015 is supplied in a rugged plastic transit case which provides stowage for the test set, directional antenna, RF coax cable, antenna shield, breakout box, and power supply/charger.



SPECIFICATION

DME MODE SPECIFICATIONS

SIGNAL GENERATOR

A 5-minute warm-up period is required for all specifications.

OUTPUT FREQUENCY

REPLY FREQUENCY

Range

962 to 1213 MHz

Accuracy

± 10 kHz

OUTPUT LEVEL

ANTENNA PORT

Range

-67 to -2 dBm at Antenna port

Resolution

1 dB

Accuracy

± 2 dB

Distance to UUT antenna

6 to 300 ft with supplied antenna

RF I/O PORT

Range

-115 to -47 dBm

Resolution

1 dB

Accuracy

-95 dBm to -47 dBm ± 1 dB

Accuracy

-115 dBm to <-95 dBm ± 2 dB

REPLY PULSE SPACING

P1 to P2

12 μs ± 100 ns (X Channel) @ 50% peak

P1 to P2

30 μs ± 100 ns (Y Channel) @ 50% peak

REPLY PULSE WIDTH

P1/P2

3.5 μs \pm 0.5 μs

ECHO REPLY

Control

On/Off

Position

30 nmi \pm 1 nmi

Amplitude

-11 dB \pm 1 dB relative to reply level

REPLY PULSE RISE AND FALL TIMES

ALL PULSES

Rise Time

2.5 μs \pm 0.25 μs (10% to 90%)

Fall Time

2.5 μs \pm 0.25 μs (90% to 10%)

REPLY DELAY

X CHANNEL

Fixed Reply Delay

50 μs \pm 100 ns

Y CHANNEL

Fixed Reply Delay

56 μs \pm 100 ns

RANGE DELAY

X AND Y CHANNEL

Range

0 to 450.00 nmi

Resolution

0.01 nmi

Accuracy

\pm 0.01 nmi

RANGE RATE

X AND Y CHANNEL

Range

10 to 6500 kts

Resolution

1 kts

Accuracy

\pm 0.01% typical, tested to \pm 0.5%

SQUITTER

PRF

2700 Hz

Accuracy

\pm 2%

Distribution

Per ARINC 568

REPLY EFFICIENCY

Range

0 to 100%

Resolution

1% increments

Accuracy

\pm 0.5%

IDENT TONE

Selection

Selectable three letter code

Frequency

1350 Hz

Accuracy

\pm 2 Hz

UUT MEASUREMENTS

ERP

Range

+47 to +64 dBm

Resolution

0.1 dB

Accuracy

\pm 2 dB

DIRECT CONNECTION PEAK PULSE POWER

Range

+47 to +64 dBm

Resolution

0.1 dB

Accuracy

\pm 1 dB

FREQUENCY

Range

1025.00 to 1150.00 MHz

Resolution

10 kHz

Accuracy

\pm 20 kHz

INTERROGATION PULSE WIDTH

P1 AND P2 PULSE WIDTHS

Range

2.00 to 5.00 μs

Resolution

1 ns

Accuracy

\pm 50 ns

INTERROGATION PULSE SPACING

P1 to P2 Spacing

10 to 14 μs (X Channel)

P1 to P2 Spacing

34 to 38 μs (Y Channel)

Resolution

10 ns

Accuracy

\pm 20 ns

INTERROGATION PRF

Range

1 to 300 Hz

Resolution

1 Hz

Accuracy

\pm 2 Hz

TRANSPONDER MODE SPECIFICATIONS

SIGNAL GENERATOR

RF OUTPUT FREQUENCY

Interrogation Frequency

1030 MHz

Accuracy

± 10 kHz

RF OUTPUT LEVEL

ANTENNA PORT

MTL + 6 dB typical, automatically controlled for a MTL range of -83 to -68 dBm

Range

-67 to -2 dBm at antenna port

Resolution

0.5 dB

Accuracy

± 2 dB

Distance to UUT antenna

6 to 200 ft with supplied antenna

RF I/O PORT

MTL + 6 dB typical, automatically controlled

Range

-115 to -47 dBm

Resolution

0.5 dB

Accuracy

-95 to -47 dBm, ± 1 dB

Accuracy

-115 to <-95 dBm, ± 2 dB

ATCRBS/MODE S INTERROGATION PULSE SPACING

MODE A

P1 to P2

2.00 μ s ± 25 ns

P1 to P3

8.00 μ s ± 25 ns

MODE C

P1 to P2

2.00 μ s ± 25 ns

P1 to P3

21.00 μ s ± 25 ns

MODE S

P1 to P2

2.00 μ s ± 25 ns

P1 to P6

3.50 μ s ± 25 ns

P1 to SPR

4.75 μ s ± 25 ns

P5 to SPR

0.40 μ s ± 50 ns

INTERMODE INTERROGATION PULSE SPACING

MODE A

P1 to P3

8.00 μ s ± 25 ns

P1 to P4

10.00 μ s ± 25 ns

MODE C

P1 to P3

21.00 μ s ± 25 ns

P1 to P4

23.00 μ s ± 25 ns

INTERROGATION PULSE WIDTHS

MODE A,C,S,INTERMODE

P1,P2,P3

0.80 μ s ± 50 ns

MODE S

P6 (Short DPSK Block)

16.25 μ s ± 50 ns

P6 (Long DPSK Block)

30.25 μ s ± 50 ns

P5

0.80 μ s ± 50 ns

INTERMODE

P4 (Short)

0.80 μ s ± 50 ns

P4 (Long)

1.60 μ s ± 50 ns

INTERROGATION PULSE RISE AND FALL TIMES

ALL MODES

Rise Time

50 to 100 ns

Fall Time

50 to 200 ns

PHASE MODULATION

ALL MODES

Transition Time

≤ 80 ns

Phase Shift

180° ± 10°

SLS LEVELS

ATCRBS

SLS Level (P2)

-9 dB, -1 to +0 dB relative to P1 level

0 dB, -0 to +1 dB relative to P1 level

Off

MODE S

SLS Level (P5)

-12 dB, -1 to +0 dB relative to P6 level

+3 dB, -0 to +1 dB relative to P6 level

Off

Note: SLS level is automatically controlled in the SLS LEVEL test.

INTERROGATION TEST SIGNALS

MODE S

PRF

50 Hz ± 5 Hz

ATCRBS**PRF**235 Hz \pm 5 Hz**UUT MEASUREMENTS**

ERP (@ 1090 MHZ)

Range

+ 45.5 to + 59 dBm (35.5 to 800 watts)

Resolution

0.1 dB

Accuracy \pm 2 dB**Direct Connection Peak Pulse Power (@1090 MHz)****Range**

+ 46.5 to + 59 dBm (45 to 800 watts)

Resolution

0.1 dB

Accuracy \pm 1 dB**TRANSMITTER FREQUENCY**

Range

1087.000 to 1093.000 MHz

Resolution

10 kHz

Accuracy \pm 50 kHz**RECEIVER SENSITIVITY, RADIATED MTL**

Range

-67 to -79 dBm into 0 dBi antenna

Resolution

0.1 dB

Accuracy \pm 2 dB, typical**RECEIVER SENSITIVITY, DIRECT CONNECTION MTL**

Range

-67 to -79 dBm

Resolution

0.1 dB

Accuracy \pm 2 dB**REPLY DELAY**

ATCRBS**Range**1.80 to 7.00 μ s**Resolution**

10 ns

Accuracy \pm 50 ns**REPLY DELAY, MODE S AND ATCRBS MODE S ALL-CALL****Range**125.00 to 131.00 μ s**Resolution**

10 ns

Accuracy \pm 50 ns**REPLY DELAY JITTER**

ATCRBS**Range**0.00 to 2.30 μ s**Resolution**

1 ns

Accuracy \pm 20 ns**MODE S AND ATCRBS MODE S ALL-CALL****Range**0.00 to 6.00 μ s**Resolution**

1 ns

Accuracy \pm 20 ns**PULSE SPACING**

F1 TO F2**Range**19.70 to 21.60 μ s**Resolution**

1 ns

Accuracy \pm 20 ns**MODE S PREAMBLE****Range, P1 to P2**0.8 to 1.2 μ s**Range, P1 to P3**3.3 to 3.7 μ s**Range, P1 to P4**4.3 to 4.7 μ s**Resolution**

1 ns

Accuracy \pm 20 ns**PULSE WIDTHS**

F1 AND F2**Range**0.25 to 0.75 μ s**Resolution**

1 ns

Accuracy \pm 20 ns**MODE S PREAMBLE****Range**0.25 to 0.75 μ s**Resolution**

1 ns

Accuracy \pm 20 ns**PULSE AMPLITUDE VARIATION**

Range, Mode S (Relative to P1)

+3 to -3 dB

Range, ATCRBS (Relative to F1)

+3 to -3 dB

Resolution

0.1 dB (0.01 dB via RCI)

Accuracy

± 0.5 dB

DF 11 SQUITTER PERIOD

Range

0.10 to 4.88 sec

Resolution

10 ms

Accuracy

± 10 ms

DIVERSITY ISOLATION

Range

0 to >20 dB (Depending on Test Distance)

Test Distance

1.83m (6ft) to 28.96m (95ft)

Resolution

0.1 dB

Accuracy

± 3 dB

TCAS MODE SPECIFICATIONS

SIGNAL GENERATOR

OUTPUT FREQUENCY

REPLY FREQUENCY

1090 MHz

Accuracy

± 10 kHz

OUTPUT LEVEL (SIMULATED ERP)

ANTENNA PORT Note 1**Radiated power at 0dBi UUT antenna**

-68 dBm typical @ 10 Nmi Range, automatically controlled

Range

-67 to -2 dBm at Antenna port

Resolution

0.5 dB

Accuracy

± 2 dB

Distance to UUT antenna

6 to 300 ft with supplied antenna

RF I/O PORT**Automatic mode**

-68 dBm @ 10 Nmi Range, automatically controlled

Manual mode Range

-115 to -47 dBm

Resolution

0.5 dB

Accuracy

-95 to -47 dBm, ± 1 dB

Accuracy

-115 to <-95 dBm, ± 2 dB

REPLY PULSE SPACING

MODE C**F1 to F2**

20.30 μs ± 25 ns

F1 to C1

1.45 μs ± 25 ns

F1 to A1

2.90 μs ± 25 ns

F1 to C2

4.35 μs ± 25 ns

F1 to A2

5.80 μs ± 25 ns

F1 to C4

7.25 μs ± 25 ns

F1 to A4

8.70 μs ± 25 ns

F1 to B1

11.60 μs ± 25 ns

F1 to D1

13.05 μs ± 25 ns

F1 to B2

14.50 μs ± 25 ns

F1 to D2

15.95 μs ± 25 ns

F1 to B4

17.40 μs ± 25 ns

F1 to D4

18.85 μs ± 25 ns

MODE S**P1 to P2**

1.00 μs ± 25 ns

P1 to P3

3.50 μs ± 25 ns

P1 to P4

4.50 μs ± 25 ns

P1 to D1

8.00 μs ± 25 ns

D1 to Dn (n=2 to 112)

1.00 μs times (n-1) ± 25 ns

REPLY PULSE WIDTHS

MODE C**All Pulses**

0.45 μs ± 50 ns

MODE S**P1 through P4**

0.50 μs ± 50 ns

D1 through D112

0.50 μs ± 50 ns, 1 μs chip width

Reply Modes

TCAS I / II Mode C (with altitude reporting)

TCAS II Mode S formats 0, 11, 16

E-TCAS Modes formats 0, 4, 5, 11, 16, 20, 21

REPLY PULSE AMPLITUDES

ATCRBS

± 1 dB relative to F1

Mode S

± 1 dB relative to P1

REPLY PULSE RISE AND FALL TIMES

ALL MODES

Rise Time

50 to 100 ns

Fall Time

50 to 200 ns

PERCENT REPLY

Range

0 to 100%

Resolution

10%

Accuracy

± 1%

REPLY DELAY

ATCRBS

3.0 μ s ± 50 ns

Mode S

128 μ s ± 50 ns

RANGE DELAY

Range

0 to 260 nmi

Resolution

0.1 nmi

Accuracy

± 0.02 nmi

RANGE RATE

Range

-1200 to +1200 kts

Resolution

10 kts

Accuracy

10%

ALTITUDE RANGE

Range

-1000 to 126,000 ft

Resolution, Mode C

100 ft

Resolution, Mode S

25 ft

ALTITUDE RATE

Range

-10,000 to +10,000 fpm

Resolution

100 fpm

Accuracy

10%

SQUITTER

Control

On/Off

Rate

0.8 to 1.2 seconds, randomly distributed

RECEIVER

PULSE SPACING

ATCRBS (Mode C All Call)

S1 to P1 2.0 us

Accepts ≤ ±200 ns

Rejects ≥ ±1.0 us

P1 to P3 21.0 us

Accepts ≤ ±200 ns

Rejects (<10% Replies) ≥ ±1.0 us

P1 to P4 23.0 us

Accepts ≤ ±200 ns

Rejects (<10% Replies) ≥ ±1.0 us

Mode S

P1 to P2 2.0 us

Accepts ≤ ±200 ns

Rejects (<10% Replies) ≥ ±1.0 us

P1 to SPR 4.75 us

Accepts ≤ ±200 ns

Rejects (<10% Replies) ≥ ±1.5 us

SUPPRESSION

ATCRBS (P2 or S1)

>0.5dB above level of P1 <10% Replies

UUT MEASUREMENTS

ERP (@1030MHZ)

ATCRBS

Range

+43 to +58 dBm (20 to 631 watts)

Resolution

0.1 dB

Accuracy

± 2 dB

MODE S

Range

+43 to +58 dBm (20 to 631 watts)

Resolution

0.1 dB

Accuracy

± 2 dB

DIRECT CONNECTION PEAK PULSE POWER (@1030MHZ)

ATCRBS

Range

+43 to +58 dBm (20 to 631 watts)

Resolution

0.1 dB

Accuracy

± 1 dB

MODE S

Range

+43 to +58 dBm (20 to 631 watts)

Resolution

0.1 dB

Accuracy

± 1 dB

FREQUENCY

Range

1029.900 to 1030.100 MHz

Resolution

1 kHz

Accuracy

± 10 kHz

TCAS BROADCAST INTERVAL

Range

1.0 to 12.0 sec

Resolution

0.1 sec

Accuracy

± 0.2 sec

MISCELLANEOUS INPUT/OUTPUTS

RF I/O

Type

Input/Output

Impedance

50 Ω typical

Maximum Input Level

4 kW peak

10 W average

VSWR

< 1.3:1

ANTENNA

Type

Input/Output

Impedance

50 Ω typical

Maximum Input Level

10 W peak

1/2 W average

VIDEO

Type

Output

Impedance

50 Ω typical

Generate Video Level

1.1 ± 0.4V peak to peak into 50 Ω

Receive Video Level

Proportional to IF level

Baseline

± 0.5V referenced to ground

TEST ANTENNA

VSWR

< 1.5:1

Gain

6 dB, Typical

TIME BASE (TCXO)

Temperature Stability

± 1 ppm

Aging

± 1 ppm per year

Accuracy

± 1 ppm

Test Limit

± 0.3 ppm

BATTERY

Type

Li Ion

Duration

> 4 hrs continuous operation

> 6 hrs, Typical

INPUT POWER (TEST SET)

Input Range

11 VDC to 32 VDC

Power Consumption

55 W Maximum

16 W Nominal at 18 VDC with charged battery

Fuse Requirements

5 A, 32 VDC, Type F

INPUT POWER (SUPPLIED EXTERNAL AC TO DC CONVERTER)

Input Range

100 to 250 VAC, 1.5 A Max, 47-63 Hz

Mains Supply Voltage Fluctuations

≤ 10% of the nominal voltage

Transient Overvoltages

According to Installation Category II

ENVIRONMENTAL (TEST SET)

Use

Pollution Degree 2

Altitude

≤ 4800 meters

Operating Temperature

^{NOTE 3} -20°C to 55°C

Storage Temperature

^{NOTE 4} -30°C to 71°C

Relative Humidity

95% ±5% from 5° to 30°C

75% ±5% from 30° to 40°C

45% ±5% from 40° to 55°C

ENVIRONMENTAL (SUPPLIED EXTERNAL AC TO DC CONVERTER)

Use

Indoors

Altitude

≤ 10,000 meters

Operating Temperature

0° to 40°C

Storage Temperature

-20°C to 71°C

PHYSICAL CHARACTERISTICS

DIMENSIONS

Height

11.2 inches (28.5 cm)

Width

9.1 inches (23.1 cm)

Depth

2.7 inches (6.9 cm)

Weight (Test set only)

< 8 lbs. (3.6 kg)

SUPPLEMENTAL INFORMATION

Test Set Certifications

Altitude, operating	MIL-PRF-28800F	Class 2
Altitude, not operating	MIL-PRF-28800F	Class 2
Bench Handling	MIL-PRF-28800F	Class 2
Blowing Dust	MIL-STD-810F	Method 510.4, Procedure I
Drip-proof	MIL-PRF-28800F	Class 2
Explosive Atmosphere	MIL-STD-810F	Method 511.4, Procedure 1
Relative Humidity	MIL-PRF-28800F	Class 2
Shock, Functional	MIL-PRF-28800F	Class 2
Vibration Limits	MIL-PRF-28800F	Class 2
Temp, operating ^{NOTE 5}	MIL-PRF-28800F	Class 2
Temp, not operating ^{NOTE 6}	MIL-PRF-28800F	Class 2
Transit Drop	MIL-PRF-28800F	Class 2
Safety Compliance	UL-61010B-1 EN 61010-1 CSA 22.2 No 61010-1	
EMC	EN 61326	

EXTERNAL AC-DC CONVERTER CERTIFICATIONS

Safety Compliance	UL 1950 DS CSA 22.2 No. 234 VDE EN 60 950
EMI/RFI Compliance EMC	FCC Docket 20780 Curve "B" EN 61326

TRANSIT CASE CERTIFICATIONS

Drop Test	FED-STD-101C	Method 5007.1 Paragraph 6.3, Procedure A, Level A
Falling Dart Impact	ATA 300	Category I
Vibration, Loose Cargo	FED-STD-101C	Method 5019
Vibration, Sweep	ATA 300	Category I
Simulated Rainfall	MIL-STD-810F	Method 506.4 Procedure II of 4.1.2
	FED-STD-101C	Method 5009.1 Sec 6.7.1
Immersion	MIL-STD-810F	Method 512.4

Notes

- ^{NOTE 1} Simulates a 50.5 dBm XPDR ERP at 10 nMi range.
- ^{NOTE 2} Level automatically controlled based on actual distance to UUT antenna.
- ^{NOTE 3} Battery charging temperature range: 5°C to 40°C (controlled by internal charger).
- ^{NOTE 4} Li Ion Battery must be removed below -20°C and above 60°C.
- ^{NOTE 5} Temperature range extended to -20°C to 55°C.
- ^{NOTE 6} Temperature range reduced to -30°C to 71°C.

VERSIONS AND ACCESSORIES

When ordering please quote the full ordering number information.

Ordering Numbers

6015-110

6015-220

6015OPT3

Extended Standard Warranties with Calibration for 6015

W6015/203C	Extended standard warranty 36 months with scheduled calibration
W6015/205C	Extended standard warranty 60 months with scheduled calibration

Accessories for 6015

AC0820	Desk Top Stand
AC0826	Tripod
AC0825CD	IFR 6015 Operation Manual - CD
AC24006	Tripod, Dolly, Stand

EXPORT CONTROL:

This product is controlled for export under the International Traffic in Arms Regulations (ITAR). A license from the U.S. Department of State is required prior to the export of this product from the United States.

EXPORT WARNING:

Aeroflex's military products are controlled for export under the International Traffic in Arms Regulations (ITAR) and may not be sold or proposed or offered for sale to certain countries including: Belarus, Burma, China, Cuba, Haiti, Iran, Liberia, Libya, North Korea, Somalia, Syria, Sudan, and Vietnam. See ITAR 126.1 for complete information.

FINLAND

Tel: [+358] (9) 2709 5541
Fax: [+358] (9) 804 2441

FRANCE

Tel: [+33] 1 60 79 96 00
Fax: [+33] 1 60 77 69 22

GERMANY

Tel: [+49] 8131 2926-0
Fax: [+49] 8131 2926-130

INDIA

Tel: [+91] 80 5115 4501
Fax: [+91] 80 5115 4502

KOREA

Tel: [+82] (2) 3424 2719
Fax: [+82] (2) 3424 8620

SCANDINAVIA

Tel: [+45] 9614 0045
Fax: [+45] 9614 0047

SPAIN

Tel: [+34] (91) 640 11 34
Fax: [+34] (91) 640 06 40

UK Burnham

Tel: [+44] (0) 1628 604455
Fax: [+44] (0) 1628 662017

UK Cambridge

Tel: [+44] (0) 1763 262277
Fax: [+44] (0) 1763 285353

UK Stevenage

Tel: [+44] (0) 1438 742200
Fax: [+44] (0) 1438 727601
Freephone: 0800 282388

USA

Tel: [+1] (316) 522 4981
Fax: [+1] (316) 522 1360
Toll Free: 800 835 2352



As we are always seeking to improve our products, the information in this document gives only a general indication of the product capacity, performance and suitability, none of which shall form part of any contract. We reserve the right to make design changes without notice. All trademarks are acknowledged. Parent company Aeroflex, Inc. ©Aeroflex 2006.

www.aeroflex.com
info-test@ aeroflex.com



Our passion for performance is defined by three attributes represented by these three icons: solution-minded, performance-driven and customer-focused.

Part No. 46891/263, Issue 1, 01/06