

iC-LQNP

PULSE AND AC LIGHT SENSOR



Rev B1, Page 1/10

FEATURES

- ◆ Fast response amplifier with on-chip photodiode
- ◆ High interference immunity due to monolithic design
- ◆ Active photodiode area of ca. 1 mm²
- ◆ Suitable for visible light and near infrared
- ◆ Integrated band-pass filter with 140 kHz center frequency
- ◆ Maximum gain obtained for pulse light of 1.4 μs and upwards
- ◆ High LF and DC (ambient) light suppression
- ◆ Transfer characteristics irrespective of ambient light level
- ◆ Soft signal and noise limiter with excess ambient light
- ◆ Fast recovery from flashes
- ◆ Complementary analogue current source outputs, transimpedance can be set by external resistor
- ◆ Single 5 to 12 V supply, low power consumption also with bright ambient light
- ◆ **Options:** customised COB versions

APPLICATIONS

- ◆ Receiver for through beam and reflection light barriers with background suppression (sunlight) e.g. for presence detection in power operated gates, doors and windows etc.

PACKAGES

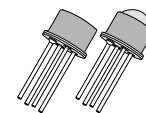

TO18-4F/L



cDFN6



oBGA LQ1C

BLOCK DIAGRAM

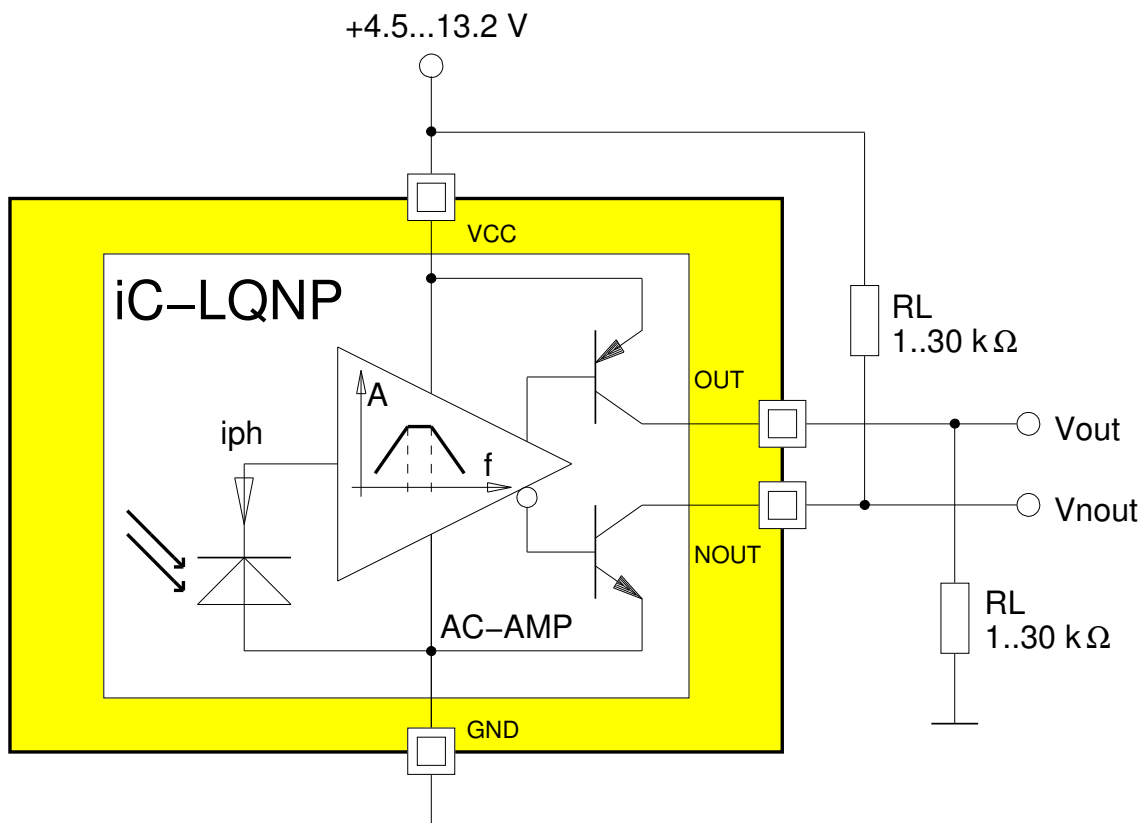

iC-LQNP

PULSE AND AC LIGHT SENSOR



Rev B1, Page 2/10

DESCRIPTION

iC-LQNP is a sensor for pulse and alternating light with a monolithically integrated photodiode. The device supersedes conventional photoreceivers, such as those in light barriers, for example.

Changes in the photocurrent are amplified whereas the photocurrents caused by background light are electronically suppressed with over 60 dB (at 100 Hz).

The integrated amplifier forms a band-pass characteristic without using any external components. The high pass filter suppresses ambient light and low frequency alternating light and the low pass filter reduces high frequency noise.

For visible light or near infrared the highest sensitivity for alternating light signals is reached at approximately 140 kHz; for pulse light this is reached at 1.4 μ s and upwards.

The transimpedance can be selected within a range of approximately 1 to 10 M Ω via the external load resistor.

iC-LQNP is available as a 4-lead TO18 metal can package with a glass lens or flat window. Customised COB versions are also possible.

iC-LQNP

PULSE AND AC LIGHT SENSOR



Rev B1, Page 3/10

PACKAGES TO18-4F/L, cDFN6, oBGA LQ1C

PIN CONFIGURATION TO18-4F/L

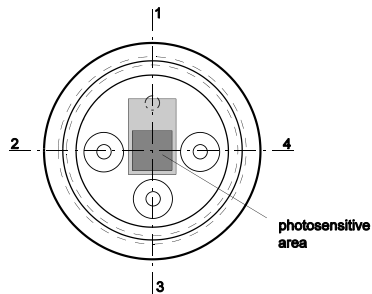

PIN FUNCTIONS

No. Name Function

- 1 GND Ground
- 2 OUT High-Side Current Output
- 3 VCC +4.5 to +13.2 V Supply Voltage
- 4 NOUT Low-Side Current Output

PIN CONFIGURATION cDFN6 3 mm x 3 mm

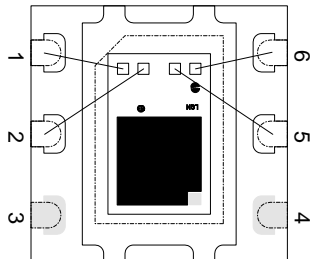

PIN FUNCTIONS

No. Name Function

- 1 GND Ground
- 2 OUT High-Side Current Output
- 3 n.c.
- 4 n.c.
- 5 NOUT Low-Side Current Output
- 6 VCC +4.5 to +13.2 V Supply Voltage

PIN CONFIGURATION oBGA LQ1C

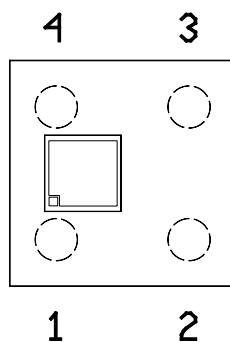

PIN FUNCTIONS

No. Name Function

- 1 GND Ground
- 2 VCC +4.5 to +13.2 V Supply Voltage
- 3 OUT High-Side Current Output
- 4 GND Ground

ABSOLUTE MAXIMUM RATINGS

Beyond these values damage may occur; device operation is not guaranteed.

Item No.	Symbol	Parameter	Conditions			Unit
				Min.	Max.	
G001	VCC	Supply Voltage		0	15	V
G002	I()	Output Current		-4	4	mA
G003	Vd()	ESD susceptibility at all pins	HBM, 100 pF discharged through 1.5 kΩ		1.5	kV
G004	Tj	Junction Temperature		-40	150	°C
G005	Ts	Storage Temperature	see package specifications			

THERMAL DATA

Operating Conditions: VCC = 4.5...13.2 V

Item No.	Symbol	Parameter	Conditions	Min.	Typ.	Max.	Unit
T01	Ta	Operating Ambient Temperature Range	cDFN6 for other packages, see relevant package specifications	-20		85	°C
T02	Tpk	Peak Temperature cDFN6	tpk < 10 s, convection reflow MSL6, TOL (max. floor life 8 h at 30 °C and 60% RH) See Customer Information #7 for detailed information.			245	°C

All voltages are referenced to ground unless otherwise stated.

All currents into the device pins are positive; all currents out of the device pins are negative.

ELECTRICAL CHARACTERISTICS

Operating Conditions: VCC = 4.5...13.2 V, R1 = 10 kΩ, CL = 20 pF, λ = 875 nm, Tj = -25...125 °C, if not otherwise stated.

Item No.	Symbol	Parameter	Conditions				Unit
				Min.	Typ.	Max.	
Total Device							
001	VCC	Permissible Supply Voltage		4.5		13.2	V
002	I(VCC)	Supply Current	E(PD) = 0 E(PD)ac = 0, E(PD)pk = 0, E(PD)cw = 30 mW/cm ² , no load	0.4	0.8	1.4 2	mA mA
003	Vs(OUT)	Output Saturation Voltage at OUT	I() = -1 mA, Vs(OUT) = VCC - V(OUT)			0.5	V
004	Vs(NOUT)	Output Saturation Voltage at NOUT	I() = 1 mA			0.5	V
005	I()	Permissible Output Current in NOUT, OUT	I(NOUT) I(OUT)	0 -2		2 0	mA mA
006	I0()	Output Bias Current in OUT	E(PD) = 0 E(PD) = 0, VCC = 5 V, Tj = 27 °C	-235	-145	-105	μA μA
007	I0()	Output Bias Current in NOUT	E(PD) = 0 E(PD) = 0, VCC = 5 V, Tj = 27 °C	105	145	235	μA μA
008	Vc(hi)	Output Clamp Voltage hi	Vc(hi) = V(OUT) - VCC, VCC = 0V, I() = 4 mA	0.25	0.5	1.4	V
009	Vc(lo)	Output Clamp Voltage lo	I() = -4 mA	-1.4	-0.5	-0.25	V
Photodiode							
101	Aph()	Radiant Sensitive Area		1			mm ²
102	S(λ)max	Spectral Sensitivity			0.5		A/W
103	λ _{ar}	Spectral Application Range	Se(λ _{ar}) = 0.1 × S(λ)max	500		1050	nm
Photocurrent Amplifier							
201	E()cw	Permissible DC Irradiance	λ _{LED} für S(λ)max, iC-LQNP Chip			30	mW/ cm ²
202	Ev()cw	Ambient Light Susceptibility	standard illuminant A, T = 2856 K; TO18-4F TO18-4L		50 7		mW/ cm ² mW/ cm ²
203	Ev()cw	Ambient Light Susceptibility	standard illuminant A, T = 2856 K; TO18-4F TO18-4L		70 10		klx klx
204	E()pk	Permissible Peak Irradiance	I((N)OUT) increases or remains constant as E()pk increases; chip, TO18-4F TO18-4L			100 15	mW/ cm ² mW/ cm ²
205	Gpk	Pulse Light Amplification 875 nm	VCC = 5 V, E(PD)pk = 35 μW/cm ² , tr = tf = 0.1 μs, twpk = 1.4 μs; chip, TO18-4F TO18-4L	100 700	220 1540	350 2500	A/W A/W
206	Gpk	Pulse Light Amplification 850 nm	see 205; chip, TO18-4F TO18-4L		250 1800		A/W A/W
207	Δt()	Output Current Delay	see 205, I((N)OUT) : 0 → 50% peak value			1.5	μs
208	trec	Recovery Time	see 205, settled better 10% to initial quiescent point			15	μs
209	trec	Power Flash Recovery Time	E(PD)pk = 35 mW/cm ² , twpk = 100 μs			60	μs
210	Gac	AC Light Amplification	f = fc, E(PD)ac = 35 μW/cm ² ; Chip, TO18-4F TO18-4L		400 2800		A/W A/W
211	fc	Bandpass Center Frequency	RI = 1 kΩ, CL = 20 pF RI = 10 kΩ, CL = 20 pF		140 120		kHz kHz
212	fhc	Upper Cut-off Frequency (-3 dB)	R1 = 1 kΩ, CL = 20 pF R1 = 10 kΩ, CL = 20 pF		400 360		kHz kHz

iC-LQNP

PULSE AND AC LIGHT SENSOR



Rev B1, Page 6/10

ELECTRICAL CHARACTERISTICS

Operating Conditions: VCC = 4.5...13.2 V, R1 = 10 kΩ, CL = 20 pF, λ = 875 nm, Tj = -25...125 °C, if not otherwise stated.

Item No.	Symbol	Parameter	Conditions	Min.	Typ.	Max.	Unit
213	f _{lc}	Lower Cut-off Frequency (-3 dB)	R1 = 1 kΩ, CL = 20 pF R1 = 10 kΩ, CL = 20 pF		40 35		kHz kHz
214	Q	Filter Q-Factor	Q = f _c / (f _{hc} - f _{lc}); R1 = 1 kΩ, CL = 20 pF R1 = 10 kΩ, CL = 20 pF		0.65 0.65		
215	G100	LF Suppression	f = 100 Hz		60		dB
216	V _n (<i>t</i>)	Output Noise Voltage (RMS)	VCC = 5 V, E(PD) = 0 VCC = 5 V, E _v (PD) _{dc} ca. 15.000 lx, standard illuminant A, T = 2856 K, chip		7 20		mV mV
217	t _{on} (VCC)	Power-On Setup Time	Tj = -25...70 °C			450	μs

CHARACTERISTICS: Diagrams

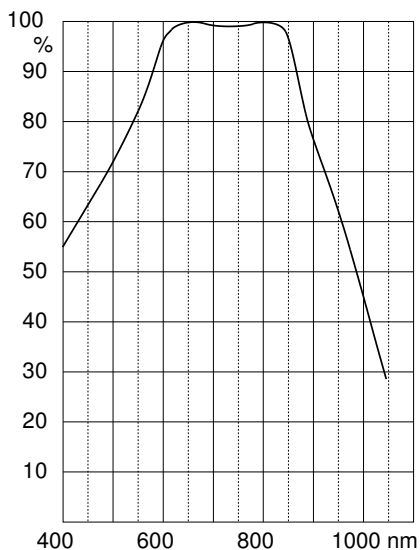

Figure 1: Typical relative spectral sensitivity

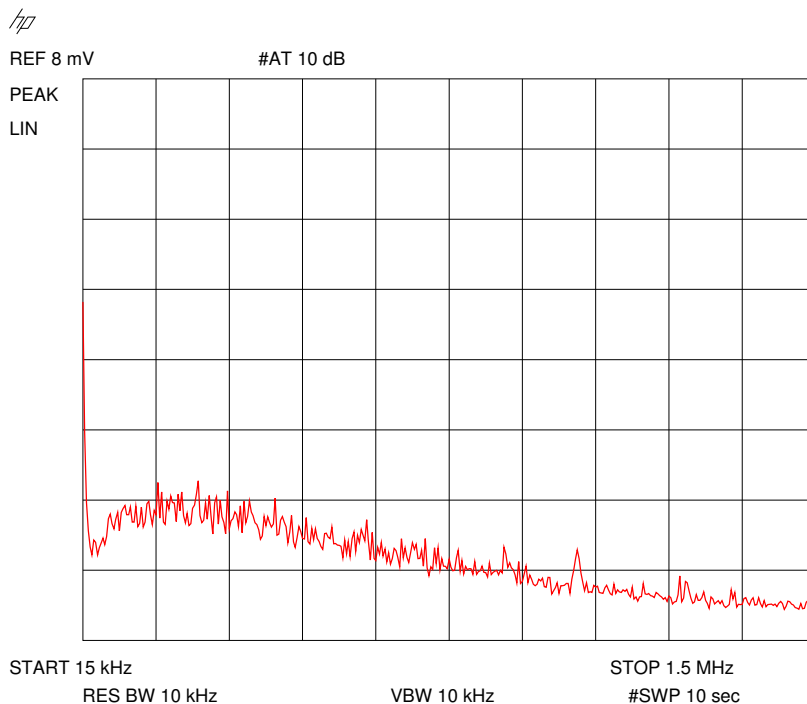

Figure 2: Output voltage noise [mV/ $\sqrt{10\text{ kHz}}$] to 10 k Ω /20 pF load with $E_v(\text{dc}) < 500\text{ lx}$

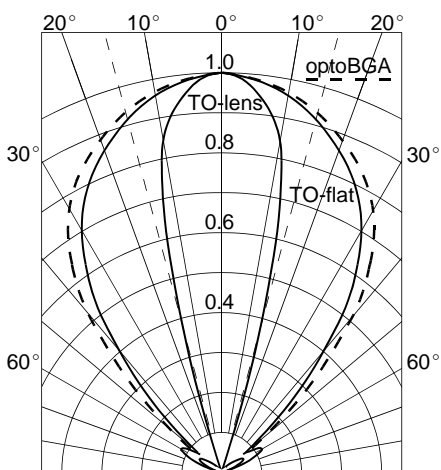

Figure 3: Typical directional characteristics for TO18 and optoBGA™ packages

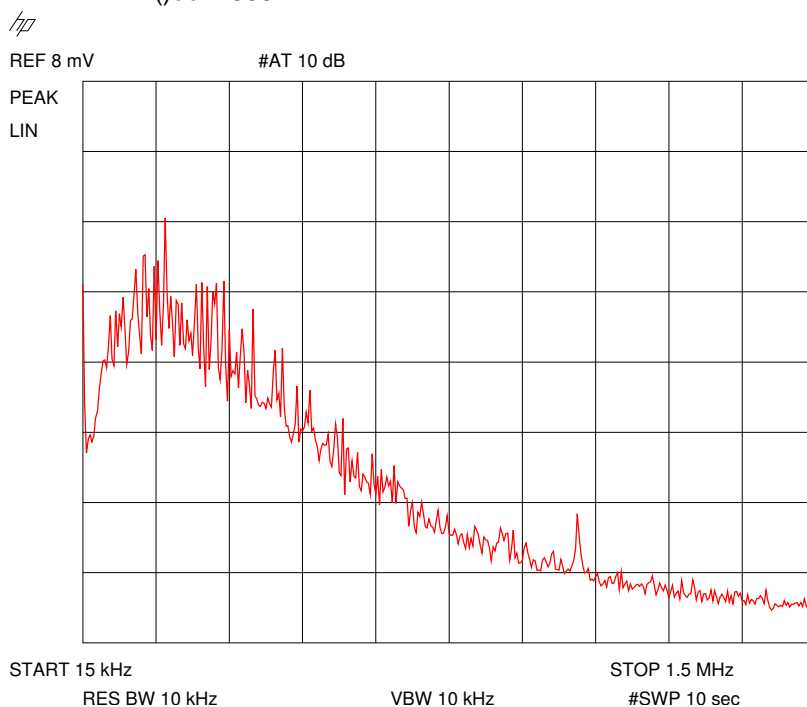

Figure 4: Output voltage noise [mV/ $\sqrt{10\text{ kHz}}$] to 10 k Ω /20 pF load with $E_v(\text{dc})$ ca. 15.000 lx (standard illuminant A, T = 2856 K)

APPLICATION HINTS

Example Output Signals

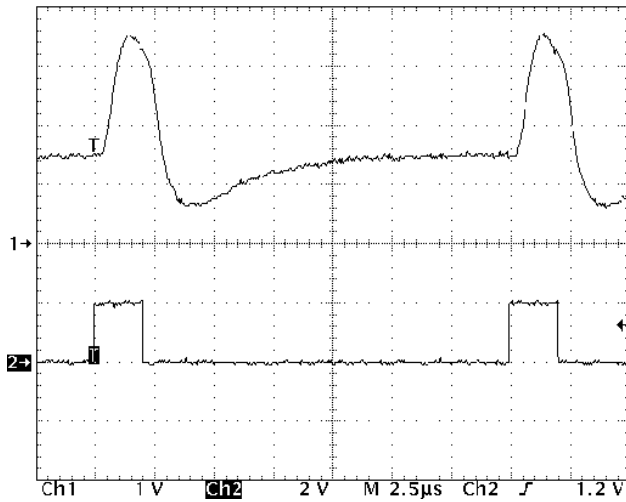

Figure 5: Output signal for 2 μ s pulse light.
Transmitter: LED 875 nm with $t_r = t_f = 0.1 \mu$ s;
VCC = 5 V, R1 = 10 k Ω , CL = 20 pF;
Chan 1: V(OUT), 1 V/DIV vertically,
Chan 2: I(LED), 20 mA/DIV vertically

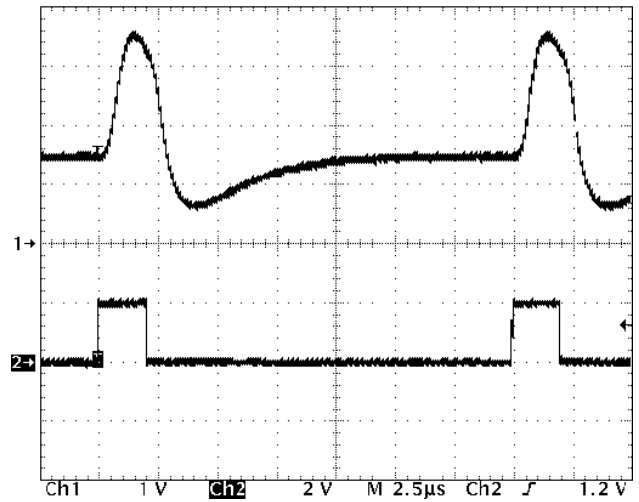

Figure 6: Output signal for 2 μ s pulse light with noise
(accumulated over 256 samples)

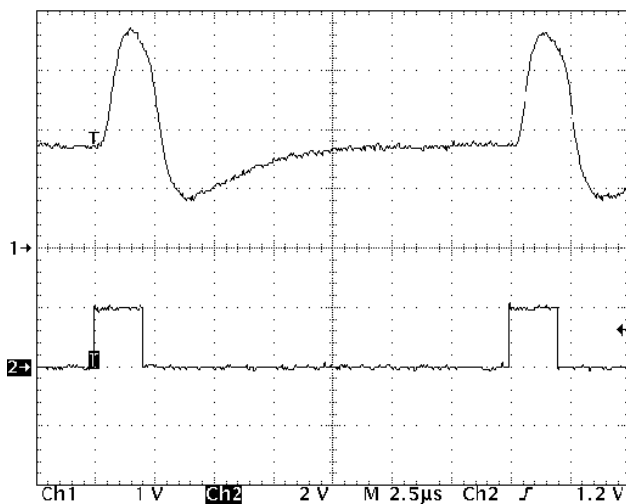

Figure 7: Output signal for 2 μ s pulse light, superimposed by ambient light of approx. 15000 Lux

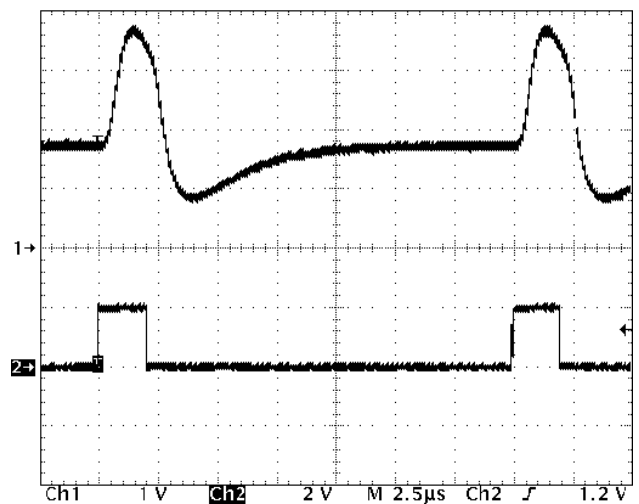

Figure 8: As in Fig. 7, accumulated for visibility over 256 samples. Despite of bright ambient light condition noise remains low level.

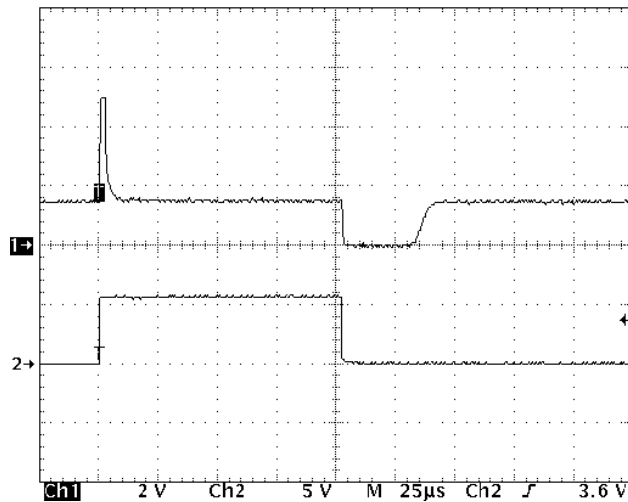

Figure 9: Recovery after 100 µs power pulse; back to ready-to-receive state after approx. 35 µs;
Chan 1: V(OUT), 2 V/DIV vertically

iC-Haus expressly reserves the right to change its products and/or specifications. An Infoletter gives details as to any amendments and additions made to the relevant current specifications on our internet website www.ichaus.de; this letter is generated automatically and shall be sent to registered users by email.

Copying – even as an excerpt – is only permitted with iC-Haus approval in writing and precise reference to source.

iC-Haus does not warrant the accuracy, completeness or timeliness of the specification on this site and does not assume liability for any errors or omissions in the materials. The data specified is intended solely for the purpose of product description. No representations or warranties, either express or implied, of merchantability, fitness for a particular purpose or of any other nature are made hereunder with respect to information/specification or the products to which information refers and no guarantee with respect to compliance to the intended use is given. In particular, this also applies to the stated possible applications or areas of applications of the product.

iC-Haus conveys no patent, copyright, mask work right or other trade mark right to this product. iC-Haus assumes no liability for any patent and/or other trade mark rights of a third party resulting from processing or handling of the product and/or any other use of the product.

As a general rule our developments, IPs, principle circuitry and range of Integrated Circuits are suitable and specifically designed for appropriate use in technical applications, such as in devices, systems and any kind of technical equipment, in so far as they do not infringe existing patent rights. In principle the range of use is limitless in a technical sense and refers to the products listed in the inventory of goods compiled for the 2008 and following export trade statistics issued annually by the Bureau of Statistics in Wiesbaden, for example, or to any product in the product catalogue published for the 2007 and following exhibitions in Hanover (Hannover-Messe).

We understand suitable application of our published designs to be state-of-the-art technology which can no longer be classed as inventive under the stipulations of patent law. Our explicit application notes are to be treated only as mere examples of the many possible and extremely advantageous uses our products can be put to.

iC-LQNP

PULSE AND AC LIGHT SENSOR



Rev B1, Page 10/10

ORDERING INFORMATION

Type	Package	Order Designation
iC-LQNP	TO18-4L TO18-4F cDFN6 oBGA LQ1C -	iC-LQNP TO18-4L iC-LQNP TO18-4F iC-LQNP cDFN6 iC-LQ oBGA LQ1C iC-LQNP chip

For technical support, information about prices and terms of delivery please contact:

iC-Haus GmbH
Am Kuemmerling 18
D-55294 Bodenheim
GERMANY

Tel.: +49 (61 35) 92 92-0
Fax: +49 (61 35) 92 92-192
Web: <http://www.ichaus.com>
E-Mail: sales@ichaus.com

Appointed local distributors: http://www.ichaus.de/support_distributors.php