

Vector Modulator/Mixer

Technical Data

HPMX-2007

Features

- 5 MHz to 4 GHz Overall Operating Frequency Range
- 40-400 MHz LMod range
- 2.7 - 5.5 V Operation (3 V, 25 mA)
- Differential High Impedance i, q Inputs
- On-Chip Linear RC Phase Shifter
- -23 dBm Modulator S.E. Output Power into 50 Ω at 150 MHz
- -15 dBm Linear (-11 dBm Saturated) Mixer Output Power into 50 Ω at 1900 MHz
- Mixer Can Be Used for Up/Down Conversion or Disabled (3 V, 10 mA)
- Standby Mode (<1 μA)
- JEDEC Standard SSOP-16 Surface Mount Package

Package Pin Configuration

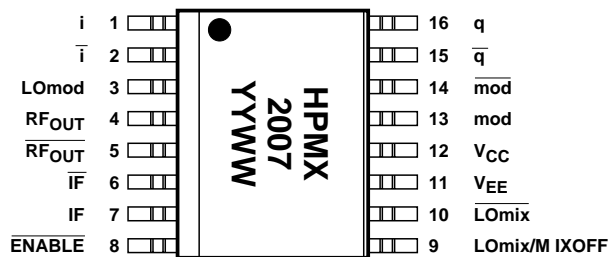

Applications

- NADC, PDC, GSM Handsets and Base Stations
- PCS Handsets and Base Stations
- DLMR Handsets
- CDPD Radios
- ISM Band Wireless Links

Plastic SSOP-16

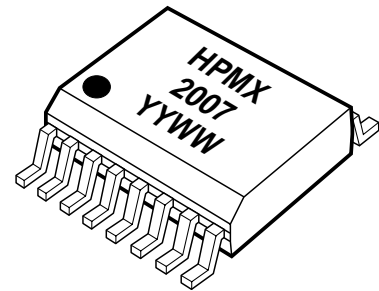

Functional Block Diagram

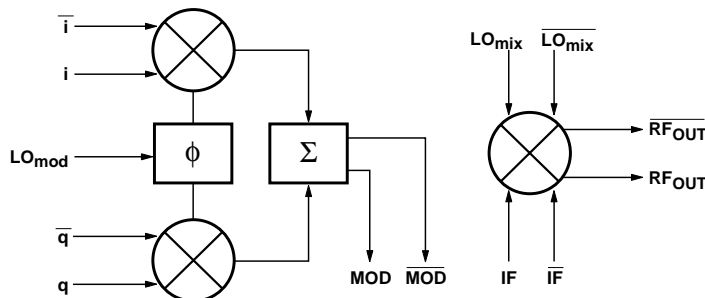

General Description

The HPMX-2007 vector modulator/mixer IC is designed to meet the needs of cellular and PCS telephone applications.

The heart of the IC is a vector (or quadrature) modulator followed by a Gilbert cell mixer. The modulator and mixer can be used together, drawing only 25 mA from a 3.0 volt supply. The mixer can be disabled by connecting either LOmix or LOmix-bar to V_{CC},

allowing operation of the modulator alone and reducing current drain to only 10 mA.

The i and q signal inputs are balanced to insure high common mode noise rejection.

The output of the mixer is a differential pair of open collectors.

One collector can be connected to V_{CC} and the other matched to $50\ \Omega$ using a shunt L, series C network. Alternatively, the output can be matched to $50\ \Omega$ through a 4:1 balun.

The SSOP-16 package insures that the IC occupies a minimal amount of printed circuit board space.

The HPMX-2007 is manufactured using Hewlett-Packard's 30 GHz ISOSAT-II process which combines stepper lithography, self alignment, ion implantation techniques and gold metallization to produce state-of-the-art RFICs.

HPMX-2007 Absolute Maximum Ratings^[1]

Recommended Operating Range of $V_{CC} = 2.7$ to 5.5 V , $T_A = -40$ to $+85^\circ\text{C}$.

Parameter	Min.	Max.
V_{CC} Supply Voltage		8 V
Power Dissipation ^[2,3]		400 mW
RF Input Power		+15 dBm
Junction Temperature		+150°C
Storage Temperature	-65°C	+150°C

Thermal Resistance:^[2]

$$\theta_{jc} = 150^\circ\text{C/W}$$

Notes:

1. Operation of this device in excess of any of these parameters may cause permanent damage.
2. $T_{case} = 25^\circ\text{C}$.
3. Derate at $7\text{ mW}/^\circ\text{C}$ for $T_{case} > 90^\circ\text{C}$.

Standard Test Conditions

Unless otherwise stated, all test data was taken on packaged parts under the following conditions:

$V_{CC} = +3.0\text{ VDC}$, $Z_{out} = 50\ \Omega$, ambient temperature $T_A = 25^\circ\text{C}$

LOmod input: 149.67 MHz, 400 mV_{p-p}, single ended

LOmix input: 1750.33 MHz, -10 dBm, single ended, $50\ \Omega$

Single sideband tests:

i, q input: 10 kHz, 600 mV_{p-p} differential with $V_{CC}/2 = 1.5\text{ V}$ offset.

See Figure 25 for test setup schematic diagram.

HPMX-2007 Key Guaranteed Electrical Specifications

Standard test conditions apply unless otherwise noted.

Symbol	Parameters and Test Conditions	Min.	Typ.	Max.	Units
P_{out}	SSB Output Power	-17.5	-15		dBm
	Unwanted Sideband Output Level in SSB Mode		-40	-30	dBc
	LOmix + LOmod Leakage Relative to SSB Output Power		-35	-27	dBc
I_d	Device Current ($\overline{\text{ENABLE}}$ Open)		25	30	mA
	Device Current, Disabled Mode ($\overline{\text{ENABLE}} = V_{CC}$)		5	25	μA

HPMX-2007 Summary Characterization Information

Standard test conditions apply unless otherwise noted.

Modulator-Only Mode	Typ	Units
DC Current Drain	10	mA
i, q Input 3 dB Bandwidth	>90	MHz
LOmod Input Frequency Range (for Sideband Suppression > 30 dBc)	40-400	MHz
SSB Output Current (Open Collectors). See Figure 26.	2	mA pk-pk diff.
SSB LOmod Suppression @ 150 MHz	-35	dBc
DSB 3rd Order IM Products @ 150 MHz	-45	dBc
Output Noise Floor	-160	dBm/Hz

Modulator + Mixer Performance (Output at 1900 MHz)	Typ	Units
Total DC Current Drain (Mixer Cannot Be Used Without Also Turning On the Modulator)	25	mA
Mixer IF Input 3 dB Bandwidth	400	MHz
Differential Output Current (Open Collectors). See Figure 26.	12	mA pk-pk diff.
Linear Output Power. See Figure 25.	-15	dBm
IM ₃ Output Power. See Figure 19.	-22	dBc
Output Noise Floor	-153	dBm/Hz
LOmix Leakage to RF Output	-22	dBc

HPMX-2007 Pin Description Table

No.	Mnemonic	Description	Typical Signal
1	i	Balanced modulation input	600 mV pk-pk differential average value of V _{CC} /2
2	\bar{i}	Z = 75 k Ω 0.5 pF	
3	LOmod	Modulator LO input Z = 5 k Ω 0.5 pF	40-400 MHz, -10 dBm from 50 Ω source
4	RF	Balanced mixer RF output open collectors Z = current src. 3 k Ω 0.7 pF	5-4000 MHz, 12 mA pk-pk differential, with network shown in Figure 25
5	\overline{RF}		
6	\overline{IF}	Balanced mixer input Z = 5 k Ω 0.5 pF	40-400 MHz, 350 mV pk-pk diff.
7	IF		
8	\overline{ENABLE}	Chip enable input	3 V CMOS logic compatible
9	LOmix/mixoff	Balanced mixer LO input and mixer enable line Z = 1 k Ω 0.6 pF	-10 dBm from 50 Ω source network shown in Figure 25
10	$\overline{LO1}$		
11	V _{EE}	Chip substrate connection	0 V (DC and AC ground)
12	V _{CC}	Power supply connection	+2.7 -5.5 V
13	MOD	Balanced modulator RF output open collectors Z = current src. 35 k Ω 0.7 pF	40-400 MHz, 2 mA pk-pk differential with network shown in Figure 25
14	\overline{MOD}		
15	\bar{q}	Balanced modulation input Z = 75 k Ω 0.5 pF	600 mV pk-pk differential average value of V _{CC} /2
16	q		

Note: Impedances shown are AC equivalents at each pin, relative to ground. See Figure 26.

Table 1. Typical Output Spurs.

All values in dBc relative to output at 1900 MHz. $f_{LOmix} = 1750.33$ MHz, $f_{LOmod} = 149.67$ MHz, $V_i = V_q = 1.65$ V, $V_{\bar{i}} = V_{\bar{q}} = 1.35$ V, $f_{spur} = m * f_{LOmix} + n * f_{LOmod}$

m ↓ n →	-6	-5	-4	-3	-2	-1	0	1	2	3	4	5	6
0	-38.8	-53.4	-47.7	-60.1	-46.7	-72.3	-	-72.2	-46.7	-60.1	-47.6	-53.3	-38.8
1	-51.9	-37.3	-37.7	-23.9	-23.6	0	-21.4	0	-22.1	-17.7	-41.7	-28.7	-35.1
2	-26.6	-32.8	-23.7	-36.3	-16.5	-34.5	-19.5	-21.3	-26.3	-36.8	-29.5	-48.8	-40.6
3	-37.8	-32.7	-57.4	-28.3	-25.9	-21.2	-27.5	-23.8	-38.7	-45.9	-54.3	-41.2	-48.8
4	-45.7	-47.1	-45.3	-47.0	-39.4	-51.1	-43.3	-40.4	-49.7	-54.7	-49.8	-57.8	-57.2
5	-65.0	-67.5	-56.1	-61.7	-57.6	-52.0	-43.5	-54.8	-61.6	-65.4	-59.9	-64.7	-63.7
6	-65.5	-82.2	-65.9	-60.7	-57.4	-62.7	-57.5	-66.2	-64.9	-77.1	-72.0	-83.1	-86.3

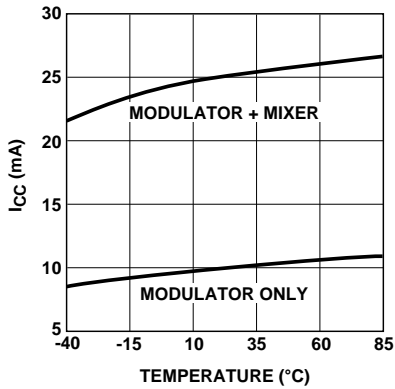

Figure 1. I_{CC} vs. Temperature.

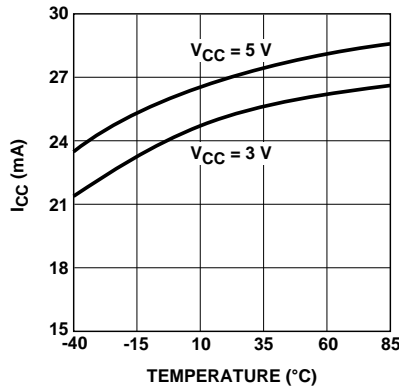

Figure 2. Modulator + Mixer I_{CC} vs. Temperature and V_{CC} .

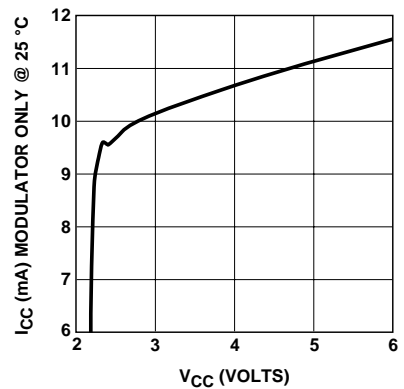

Figure 3. Modulator Only Mode I_{CC} vs. V_{CC} at 25°C.

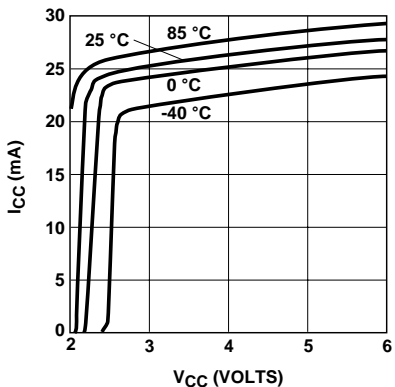

Figure 4. Modulator + Mixer I_{CC} vs. V_{CC} and Temperature.

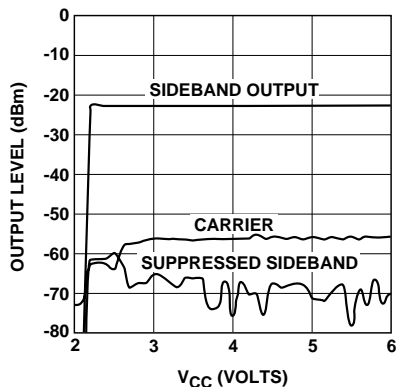

Figure 5. Modulator Only SSB Performance vs. V_{CC} .

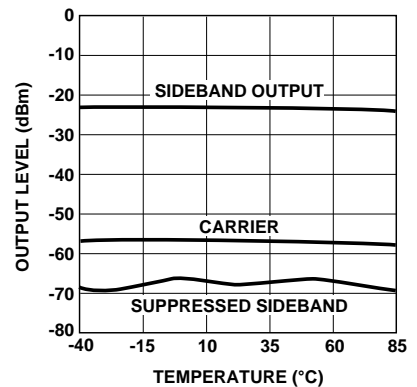

Figure 6. Modulator Only SSB Performance vs. Temperature.

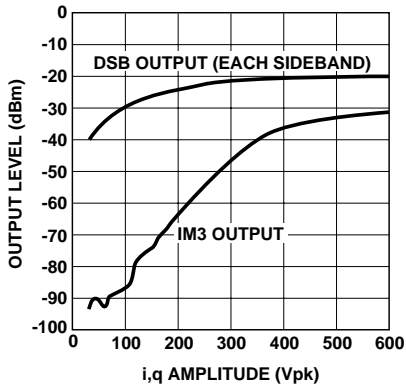

Figure 7. Modulator Only DSB Output Power Level and IM3 Level vs. i,q Input Amplitude (Each Pin, Relative to Ground).

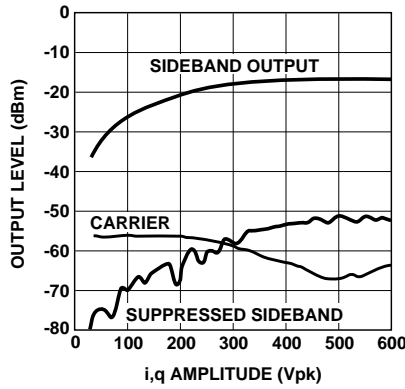

Figure 8. Modulator Only SSB Mode Performance vs. i,q Input Amplitude (Each Pin, Relative to Ground).

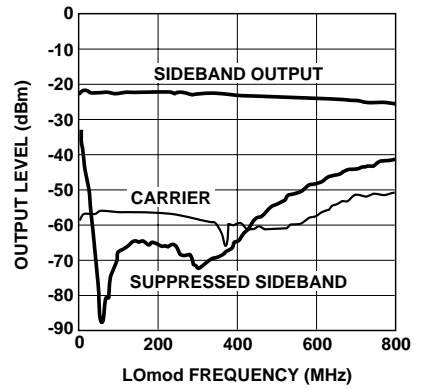

Figure 9. Modulator Only SSB Output Power, Carrier and Sideband Suppression vs. LMod Frequency.

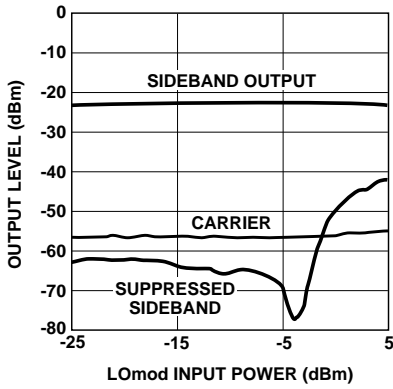

Figure 10. Modulator Only SSB Performance vs. LMod Input Level.

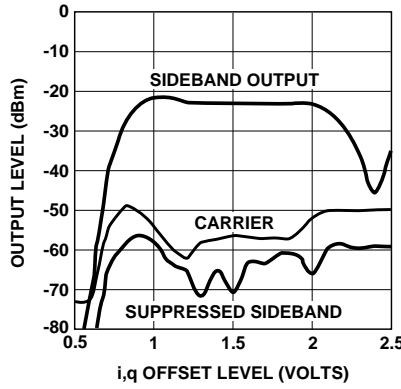

Figure 11. Modulator Only SSB Performance vs. i,q Offset Level (Each Pin, Relative to Ground).

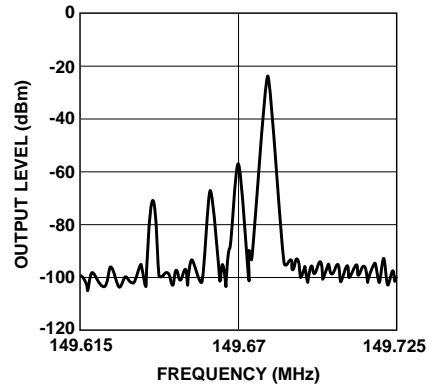

Figure 12. Modulator Only SSB Output Spectrum at 150 MHz.

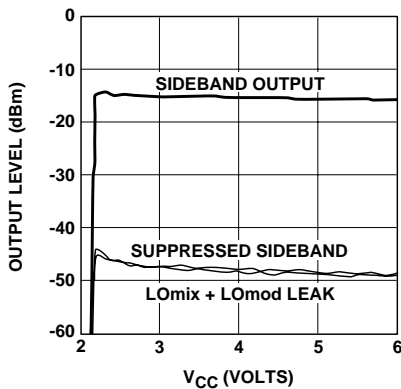

Figure 13. Modulator + Mixer SSB Output Levels vs. V_{CC} .

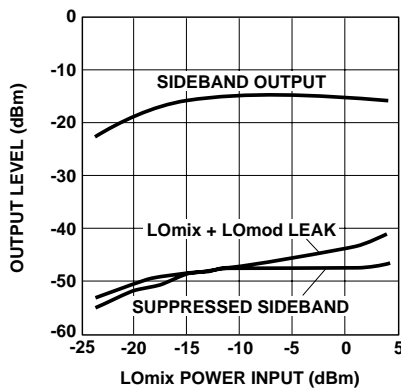

Figure 14. Modulator + Mixer SSB Output Levels vs. LOMix Power Input.

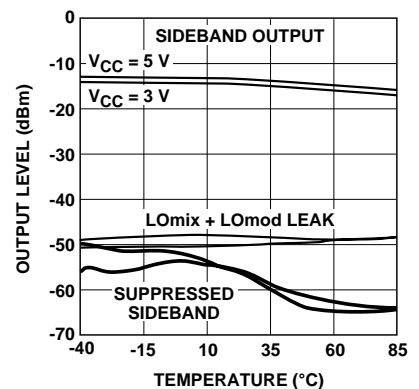

Figure 15. Modulator + Mixer SSB Output Levels vs. Temperature and V_{CC} .

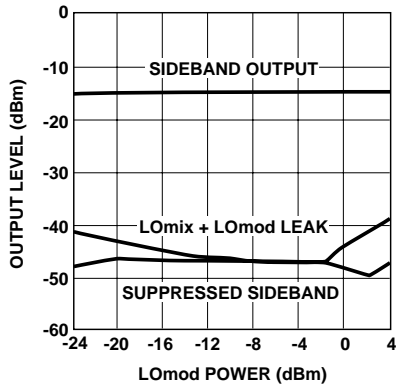

Figure 16. Modulator + Mixer SSB Output Levels vs. LMod Power Input.

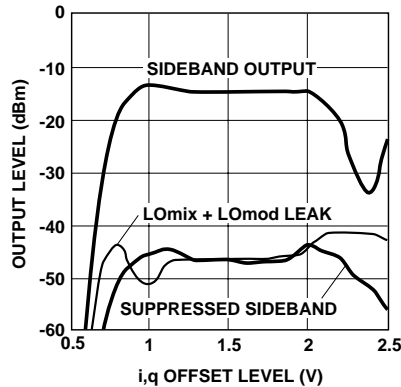

Figure 17. Modulator + Mixer SSB Performance vs. i,q Offset Level (Each Pin, Referenced to Ground).

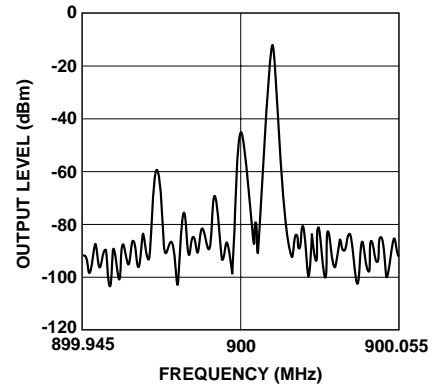

Figure 18. Modulator + Mixer SSB Output Spectrum at 900 MHz.

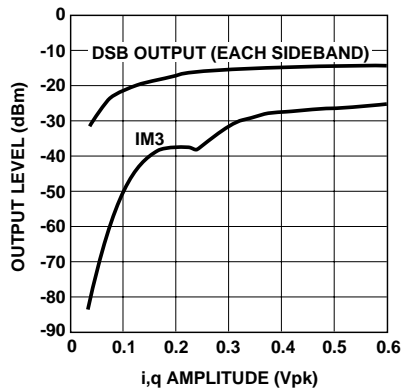

Figure 19. Modulator + Mixer DSB Performance vs. i,q Amplitude (Each Pin, Referenced to Ground).

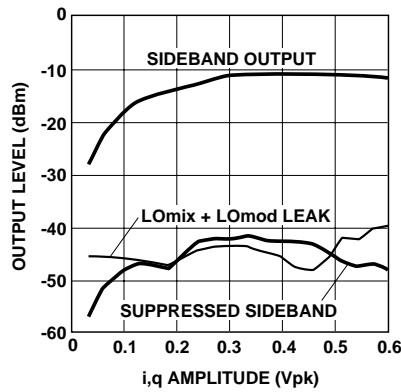

Figure 20. Modulator + Mixer SSB Performance vs. i,q Input Amplitude (Each Pin, Referenced to Ground).

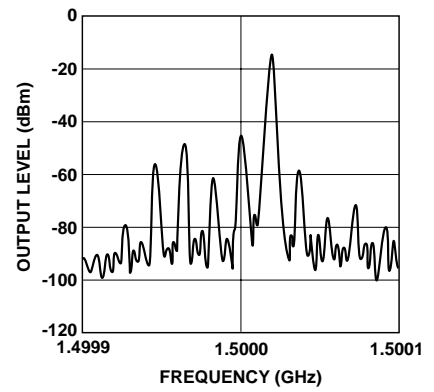

Figure 21. Modulator + Mixer SSB Output Spectrum at 1500 MHz.

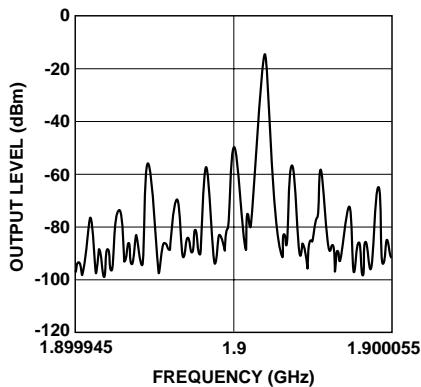

Figure 22. Modulator + Mixer SSB Output Spectrum at 1900 MHz.

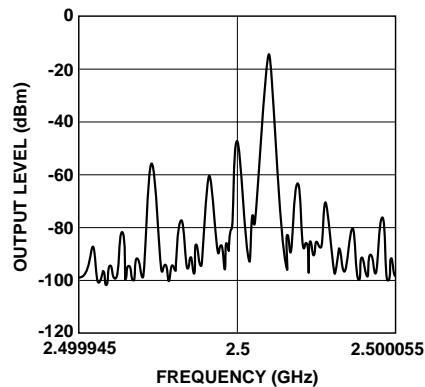

Figure 23. Modulator + Mixer SSB Output Spectrum at 2500 MHz.

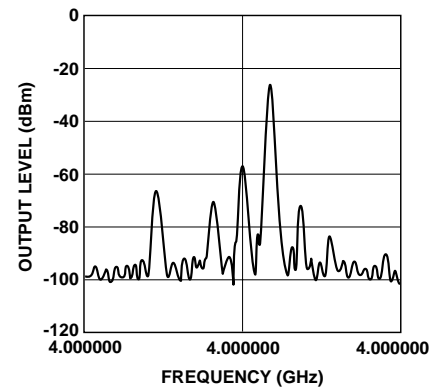

Figure 24. Modulator + Mixer SSB Output Spectrum at 4000 MHz.

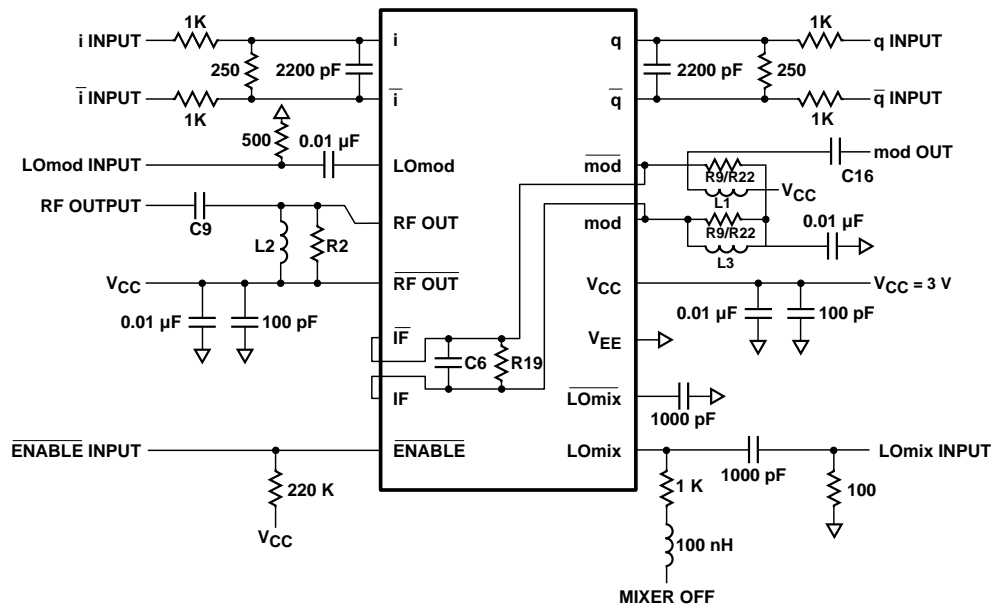

Figure 25. Test Board Schematic Diagram. Connecting the Mixer Off Line to +3 V Turns Off the Mixer. Leave It Open to Allow Mixer to Operate. Component Values that Change with Frequency Are Shown in Table 2.

Table 2. Test Board Component Values that Change with Operating Frequency.

Refer to Figure 25.

$f_{LOmix} + f_{LOmod}$ MHz	f_{LOmix} MHz	f_{LOmod} MHz	R9/R22 Ω	L3 nH	L1 nH	R19 Ω	C6 pF	C16 nF	R2 Ω	L2 nH	C9 pF
900	750.33	149.67	-	100	100	430	3.9		200	12	3.3
1500	1350.33	149.67	-	100	100	300	3.9		120	5.6	1.8
1900	1750.33	149.67	-	100	100	430	3.9		120	3.3	1.2
2500	2350.33	149.67	-	100	100	430	3.9		75	-	-
mod. only	-	149.67	300	0	-	-	-	10	-	-	-

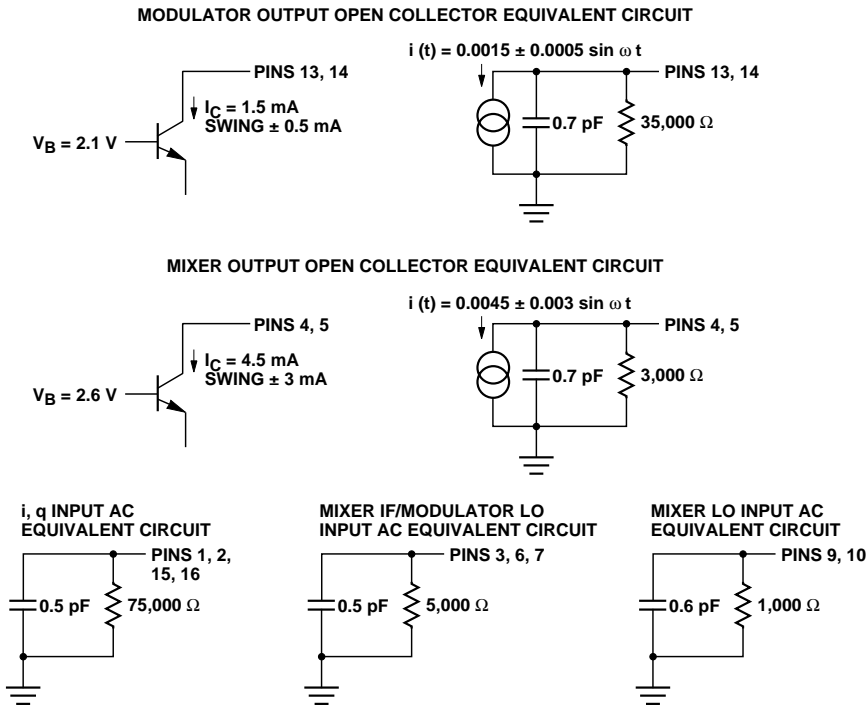
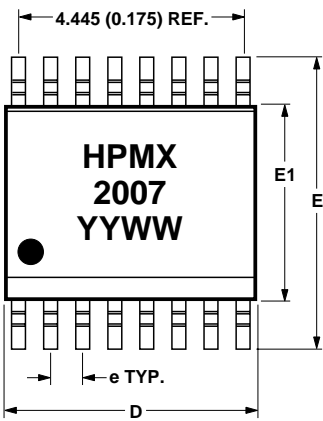

Figure 26. Equivalent Circuits for HPMX-2007 Inputs/Outputs.

Part Number Ordering Information

Part Number	No. of Devices	Container
HPMX-2007-BLK	25	Tape
HPMX-2007-TR1	1000	Tape and Reel

Package Dimensions JEDEC Standard SSOP-16 Package



SYMBOL	DIMENSIONS	
	MIN.	MAX.
A	1.372 (0.054)	1.575 (0.062)
A1	0.127 (0.005)	0.254 (0.010)
b	0.203 (0.008)	0.305 (0.012)
C	0.178 (0.007)	0.254 (0.010)
D	4.801 (0.189)	5.004 (0.197)
E	5.867 (0.231)	6.121 (0.241)
e	0.635 BSC (0.025)	
E1	3.835 (0.151)	3.988 (0.157)
h	0.305 (0.012)	0.457 (0.018)
L	0.533 (0.021)	0.787 (0.031)
θ	0	8

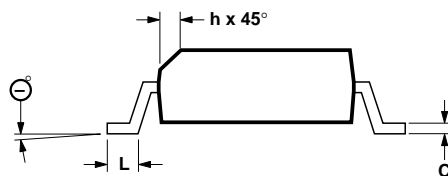
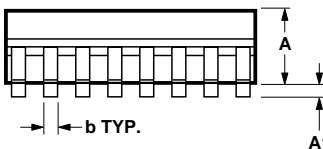

DIMENSIONS IN MILLIMETERS AND (INCHES).