

## GaAs PHEMT MMIC WIDEBAND DRIVER AMPLIFIER, 2 - 35 GHz

### Typical Applications

The HMC562 wideband driver is ideal for:

- Military & Space
- Test Instrumentation
- Fiber Optics

### Features

- P1dB Output Power: +12 dBm
- Gain: 12.5 dB
- Output IP3: +19 dBm
- Supply Voltage: +8V @ 80 mA
- 50 Ohm Matched Input/Output
- 3.12 mm x 1.42 mm x 0.1 mm

### Functional Diagram

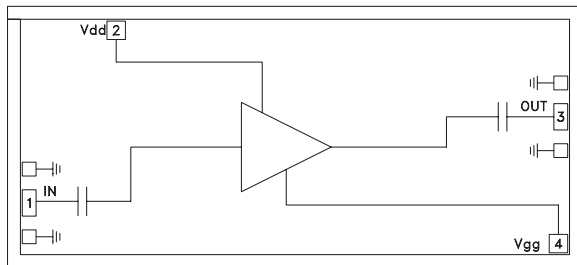

### General Description

The HMC562 is a GaAs MMIC PHEMT Distributed Driver Amplifier die which operates between 2 and 35 GHz. The amplifier provides 12.5 dB of gain, +19 dBm output IP3 and +12 dBm of output power at 1 dB gain compression while requiring 80 mA from a +8V supply. The HMC562 is ideal for EW, ECM and radar driver amplifier applications. The HMC562 amplifier I/O's are DC blocked and internally matched to 50 Ohms facilitating integration into Multi-Chip-Modules (MCMs). All data is taken with the chip connected via two 0.075mm (3 mil) ribbon bonds of minimal length 0.31mm (12 mils).

### Electrical Specifications, $T_A = +25^\circ \text{C}$ , $V_{dd} = +8\text{V}$ , $I_{dd} = 80 \text{ mA}^*$

Parameter	Min.	Typ.	Max.	Min.	Typ.	Max.	Min.	Typ.	Max.	Units
Frequency Range	2.0 - 15.0			15.0 - 27.0			27.0 - 35.0			GHz
Gain	9.5	12.5		8.5	12		7	10		dB
Gain Flatness		$\pm 0.4$			$\pm 0.35$			$\pm 1.3$		dB
Gain Variation Over Temperature		0.01	0.02		0.01	0.02		0.02	0.03	dB/°C
Input Return Loss		14			13			10		dB
Output Return Loss		16			15			12		dB
Output Power for 1 dB Compression (P1dB)	15	18		14	17		10	14		dBm
Saturated Output Power (Psat)		21.5			20			16		dBm
Output Third Order Intercept (IP3)		27			24			22		dBm
Noise Figure		3			3.5			5		dB
Supply Current (I <sub>dd</sub> ) (V <sub>dd</sub> = 8V, V <sub>gg</sub> = -0.8V Typ.)		80			80			80		mA

\* Adjust V<sub>gg</sub> between -2 to 0V to achieve I<sub>dd</sub> = 80 mA typical.

For price, delivery, and to place orders, please contact Hittite Microwave Corporation:  
20 Alpha Road, Chelmsford, MA 01824 Phone: 978-250-3343 Fax: 978-250-3373  
Order On-line at [www.hittite.com](http://www.hittite.com)

**GaAs PHEMT MMIC WIDEBAND DRIVER AMPLIFIER, 2 - 35 GHz**

**Gain & Return Loss**

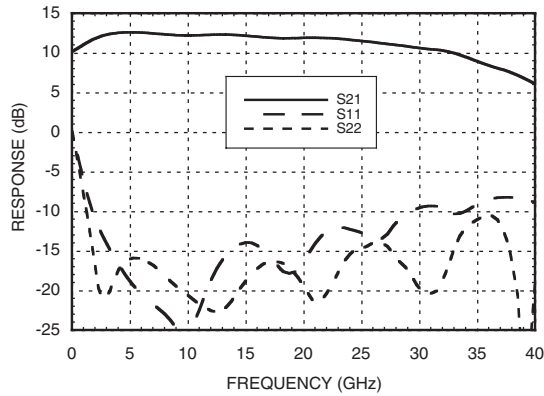

**Gain vs. Temperature**

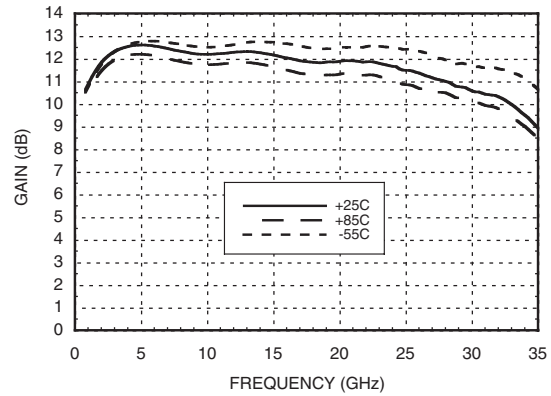

**Input Return Loss vs. Temperature**

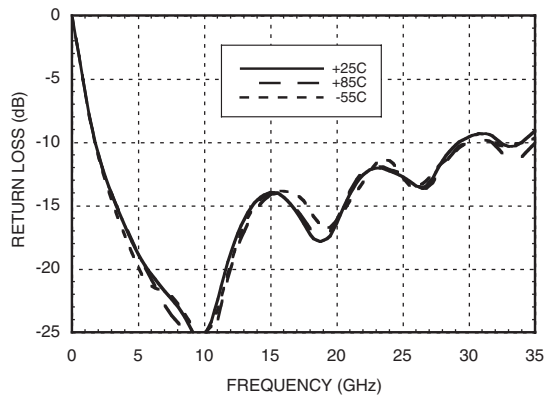

**Output Return Loss vs. Temperature**

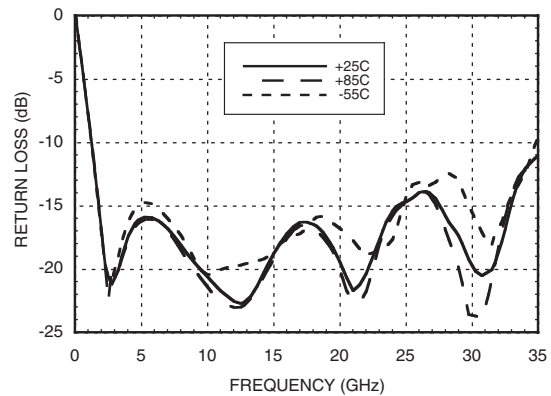

**Reverse Isolation vs. Temperature**

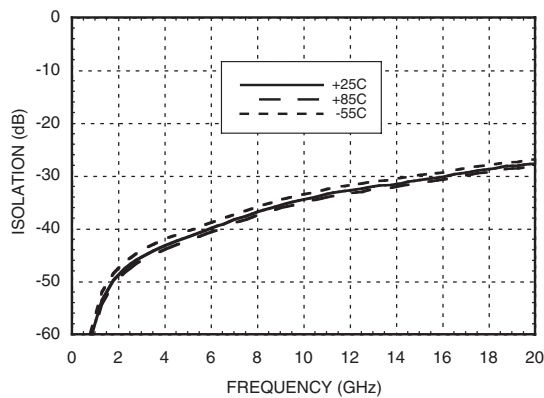

**Noise Figure vs. Temperature**

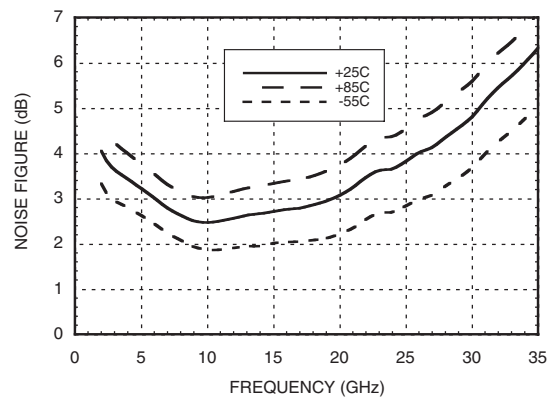

**GaAs PHEMT MMIC WIDEBAND DRIVER AMPLIFIER, 2 - 35 GHz**

**P1dB vs. Temperature**

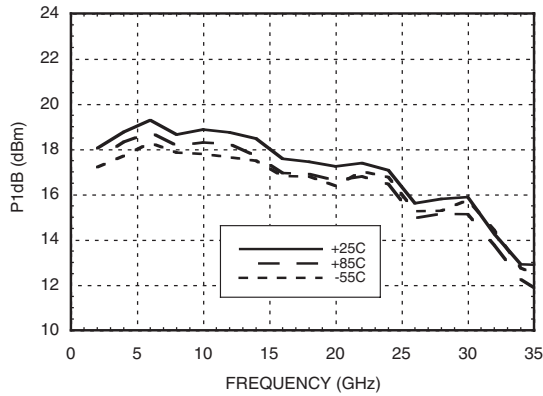

**Psat vs. Temperature**

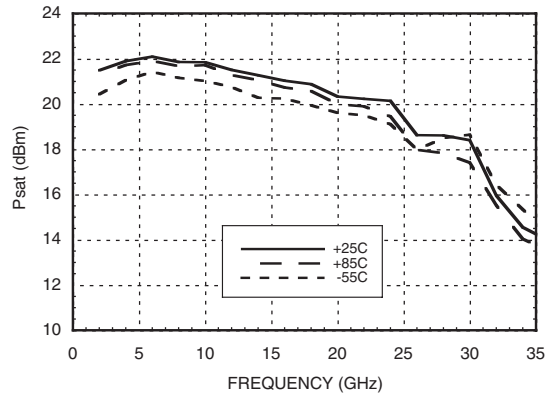

**Output IP3 vs. Temperature**

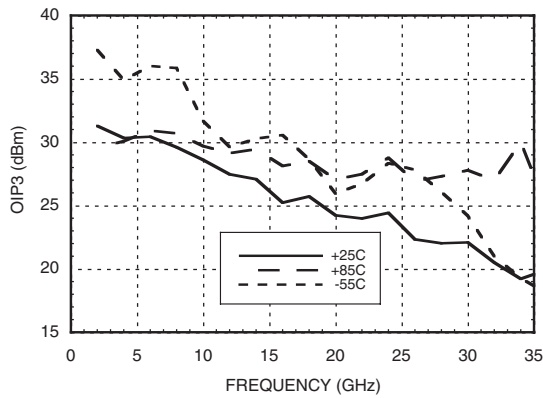

**Gain, Power & OIP3 vs. Supply Voltage @ 10 GHz, Fixed Vgg**

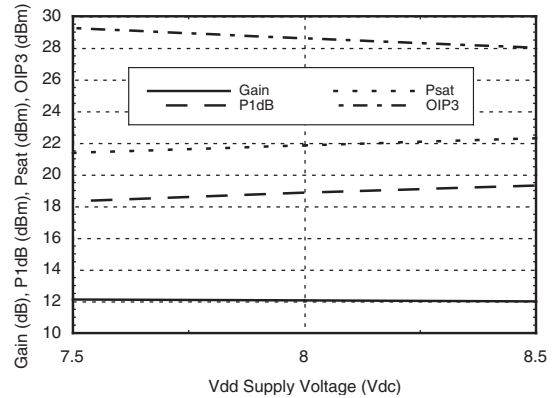

**Power Compression @ 10 GHz**

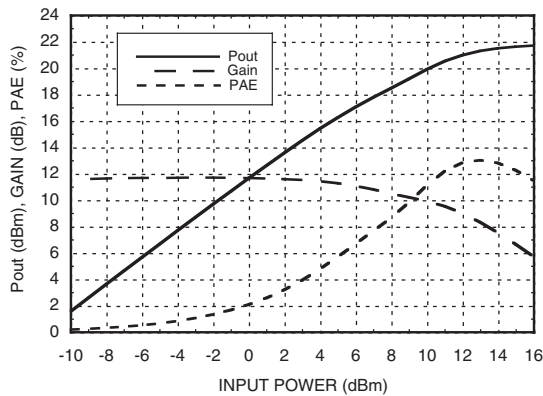

**Power Compression @ 30 GHz**

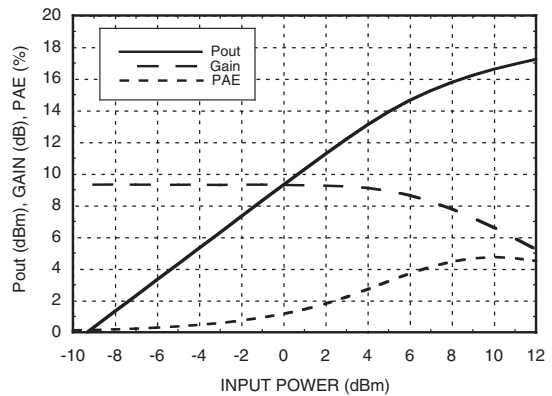

**GaAs PHEMT MMIC WIDEBAND  
DRIVER AMPLIFIER, 2 - 35 GHz**

**Absolute Maximum Ratings**

Drain Bias Voltage (Vdd)	+10 Vdc
Gate Bias Voltage (Vgg)	-2.0 to 0 Vdc
RF Input Power (RFIn)(Vdd = +10 Vdc)	+23 dBm
Channel Temperature	175 °C
Continuous Pdiss (T= 85 °C) (derate 26 mW/°C above 85 °C)	2.3 W
Thermal Resistance (channel to die bottom)	39 °C/W
Storage Temperature	-65 to +150 °C
Operating Temperature	-55 to +85 °C
ESD Sensitivity (HBM)	Class 1A

**Typical Supply Current vs. Vdd**

Vdd (V)	Idd (mA)
+7.5	79
+8	80
+8.5	81



**ELECTROSTATIC SENSITIVE DEVICE  
OBSERVE HANDLING PRECAUTIONS**

## GaAs PHEMT MMIC WIDEBAND DRIVER AMPLIFIER, 2 - 35 GHz

### Outline Drawing

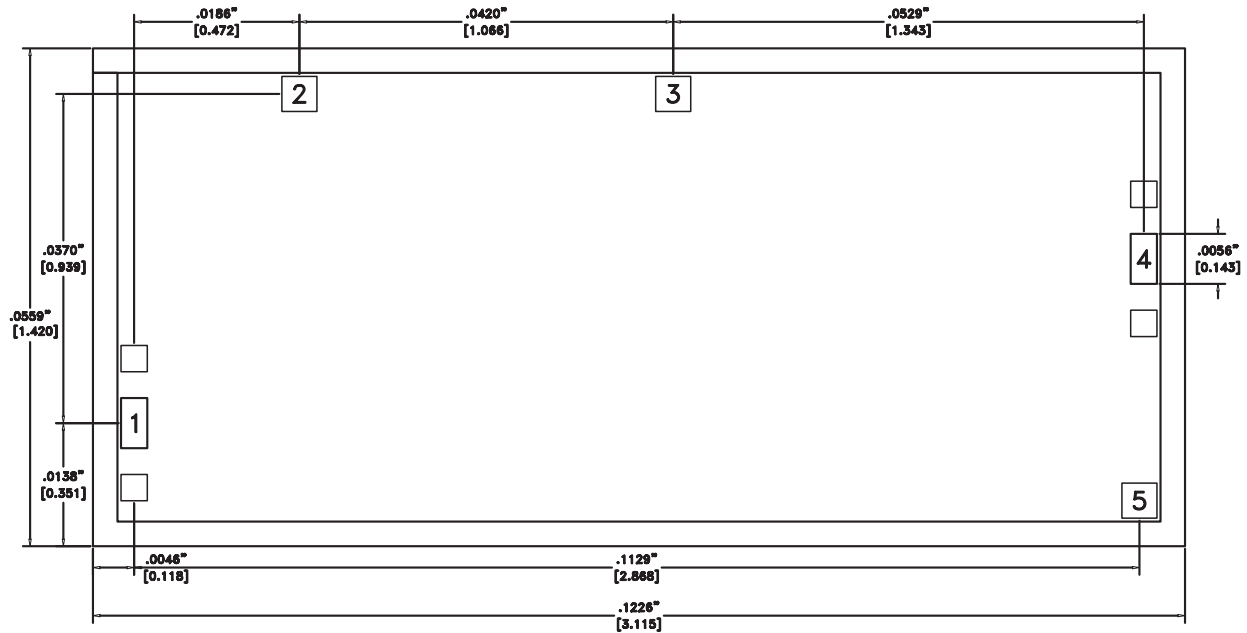

### Die Packaging Information [1]

Standard	Alternate
GP-1	[2]

[1] Refer to the "Packaging Information" section for die packaging dimensions.



[2] For alternate packaging information contact Hittite Microwave Corporation.

#### NOTES:

1. ALL DIMENSIONS IN INCHES [MILLIMETERS]
2. DIE THICKNESS IS 0.004 (0.100)
3. TYPICAL BOND PAD IS 0.004 (0.100) SQUARE
4. BOND PAD METALLIZATION: GOLD
5. BACKSIDE METALLIZATION: GOLD
6. BACKSIDE METAL IS GROUND
7. NO CONNECTION REQUIRED FOR UNLABELED BOND PADS
8. OVERALL DIE SIZE IS ±.002

**GaAs PHEMT MMIC WIDEBAND  
DRIVER AMPLIFIER, 2 - 35 GHz**

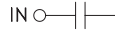
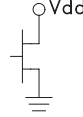
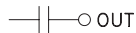
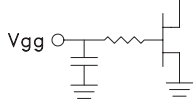
**Pad Descriptions**

Pad Number	Function	Description	Interface Schematic
1	IN	This pad is AC coupled and matched to 50 Ohms from 2 - 35 GHz.	
2	Vdd	Power supply voltage for amplifier. External bypass capacitors are required.	
3	N/C	Not connected.	
4	OUT	This pad is AC coupled and matched to 50 Ohms from 2 - 35 GHz.	
5	Vgg	Gate control for amplifier. External bypass capacitors are required. Please follow "MMIC Amplifier Biasing Procedure" application note.	
Die Bottom	GND	Die bottom must be connected to RF/DC ground.	

**GaAs PHEMT MMIC WIDEBAND DRIVER AMPLIFIER, 2 - 35 GHz**

**Assembly Diagram**

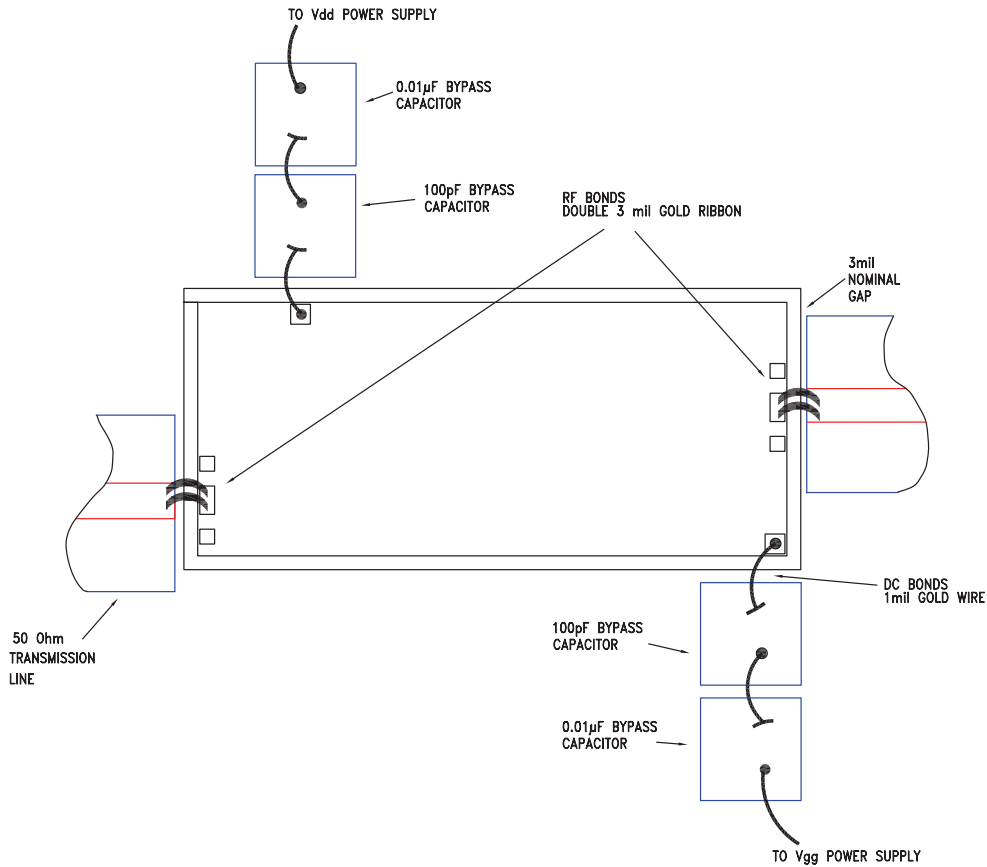

**Application Circuit**

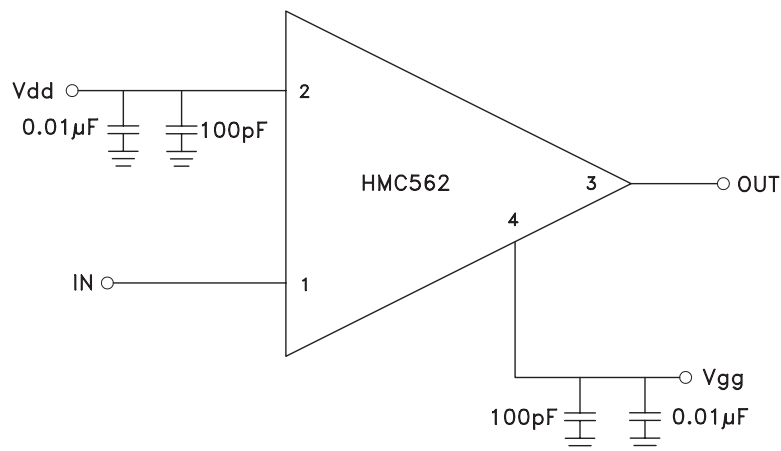

**GaAs PHEMT MMIC WIDEBAND DRIVER AMPLIFIER, 2 - 35 GHz**

**Mounting & Bonding Techniques for Millimeterwave GaAs MMICs**

The die should be attached directly to the ground plane eutectically or with conductive epoxy (see HMC general Handling, Mounting, Bonding Note).

50 Ohm Microstrip transmission lines on 0.127mm (5 mil) thick alumina thin film substrates are recommended for bringing RF to and from the chip (Figure 1). If 0.254mm (10 mil) thick alumina thin film substrates must be used, the die should be raised 0.150mm (6 mils) so that the surface of the die is coplanar with the surface of the substrate. One way to accomplish this is to attach the 0.102mm (4 mil) thick die to a 0.150mm (6 mil) thick molybdenum heat spreader (moly-tab) which is then attached to the ground plane (Figure 2).

Microstrip substrates should be placed as close to the die as possible in order to minimize bond wire length. Typical die-to-substrate spacing is 0.076mm to 0.152 mm (3 to 6 mils).

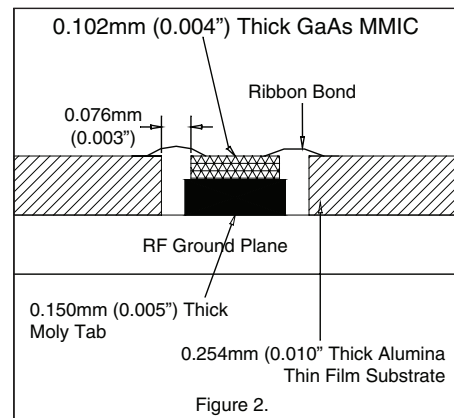
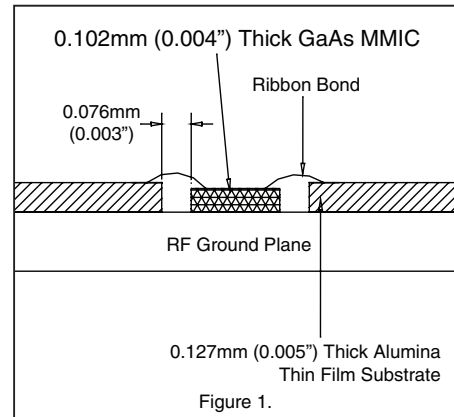

**Handling Precautions**

Follow these precautions to avoid permanent damage.

**Storage:** All bare die are placed in either Waffle or Gel based ESD protective containers, and then sealed in an ESD protective bag for shipment. Once the sealed ESD protective bag has been opened, all die should be stored in a dry nitrogen environment.

**Cleanliness:** Handle the chips in a clean environment. DO NOT attempt to clean the chip using liquid cleaning systems.

**Static Sensitivity:** Follow ESD precautions to protect against > ± 250V ESD strikes.

**Transients:** Suppress instrument and bias supply transients while bias is applied. Use shielded signal and bias cables to minimize inductive pick-up.

**General Handling:** Handle the chip along the edges with a vacuum collet or with a sharp pair of bent tweezers. The surface of the chip has fragile air bridges and should not be touched with vacuum collet, tweezers, or fingers.

**Mounting**

The chip is back-metallized and can be die mounted with AuSn eutectic preforms or with electrically conductive epoxy. The mounting surface should be clean and flat.

**Eutectic Die Attach:** A 80/20 gold tin preform is recommended with a work surface temperature of 255 deg. C and a tool temperature of 265 deg. C. When hot 90/10 nitrogen/hydrogen gas is applied, tool tip temperature should be 290 deg. C. DO NOT expose the chip to a temperature greater than 320 deg. C for more than 20 seconds. No more than 3 seconds of scrubbing should be required for attachment.

**Epoxy Die Attach:** Apply a minimum amount of epoxy to the mounting surface so that a thin epoxy fillet is observed around the perimeter of the chip once it is placed into position. Cure epoxy per the manufacturer's schedule.

**Wire Bonding**

RF bonds made with 0.003" x 0.0005" ribbon are recommended. These bonds should be thermosonically bonded with a force of 40-60 grams. DC bonds of 0.001" (0.025 mm) diameter, thermosonically bonded, are recommended. Ball bonds should be made with a force of 40-50 grams and wedge bonds at 18-22 grams. All bonds should be made with a nominal stage temperature of 150 °C. A minimum amount of ultrasonic energy should be applied to achieve reliable bonds. All bonds should be as short as possible, less than 12 mils (0.31 mm).