

## GaAs PHEMT MMIC POWER AMPLIFIER, DC - 20 GHz

### Typical Applications

The HMC559 wideband PA is ideal for:

- Telecom Infrastructure
- Microwave Radio & VSAT
- Military & Space
- Test Instrumentation
- Fiber Optics

### Functional Diagram

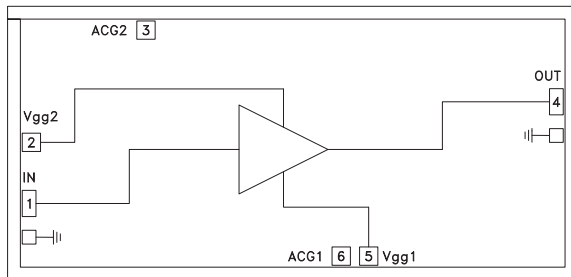

### Features

- P1dB Output Power: +28 dBm
- Gain: 14 dB
- Output IP3: +36 dBm
- Supply Voltage: +10V @ 400 mA
- 50 Ohm Matched Input/Output
- Die Size: 3.12 x 1.50 x 0.1 mm

### General Description

The HMC559 is a GaAs MMIC PHEMT Distributed Power Amplifier die which operates between DC and 20 GHz. The amplifier provides 14 dB of gain, +36 dBm output IP3 and +28 dBm of output power at 1 dB gain compression while requiring 400 mA from a +10V supply. Gain flatness is slightly positive from 4 to 20 GHz making the HMC559 ideal for EW, ECM and radar driver amplifier applications. The HMC559 amplifier I/O's are internally matched to 50 Ohms facilitating integration into Multi-Chip-Modules (MCMs). All data is taken with the chip connected via two 0.075mm (3 mil) ribbon bonds of minimal length 0.31mm (12 mils).

### Electrical Specifications, $T_A = +25^\circ \text{C}$ , $V_{dd} = +10\text{V}$ , $V_{gg2} = +4\text{V}$ , $I_{dd} = 400 \text{ mA}^*$

Parameter	Min.	Typ.	Max.	Min.	Typ.	Max.	Min.	Typ.	Max.	Units
Frequency Range	DC - 6			6 - 12			12 - 20			GHz
Gain	11	13		11	13.5		11.5	14		dB
Gain Flatness		$\pm 0.5$			$\pm 0.5$			$\pm 1.5$		dB
Gain Variation Over Temperature		0.01	0.02		0.01	0.02		0.02	0.03	dB/°C
Input Return Loss		22			15			13		dB
Output Return Loss		16			16			8		dB
Output Power for 1 dB Compression (P1dB)	25	28		24.5	27.5		23	27		dBm
Saturated Output Power (Psat)		30			29			28.5		dBm
Output Third Order Intercept (IP3)		37			36			33		dBm
Noise Figure		4.5			3.5			4.5		dB
Supply Current (I <sub>dd</sub> ) (V <sub>dd</sub> = 10V, V <sub>gg1</sub> = -0.8V Typ.)		400			400			400		mA

\* Adjust V<sub>gg1</sub> between -2 to 0V to achieve I<sub>dd</sub>= 400 mA typical.

For price, delivery, and to place orders, please contact Hittite Microwave Corporation:  
20 Alpha Road, Chelmsford, MA 01824 Phone: 978-250-3343 Fax: 978-250-3373  
Order On-line at [www.hittite.com](http://www.hittite.com)

**GaAs PHEMT MMIC  
POWER AMPLIFIER, DC - 20 GHz**

**Gain & Return Loss**

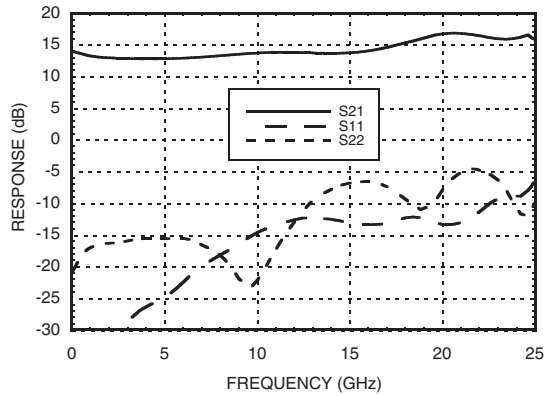

**Gain vs. Temperature**

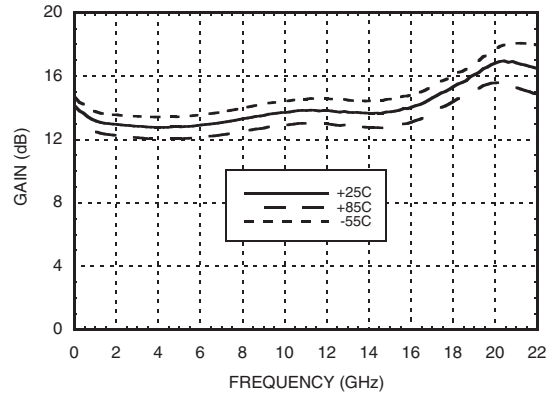

**Input Return Loss vs. Temperature**

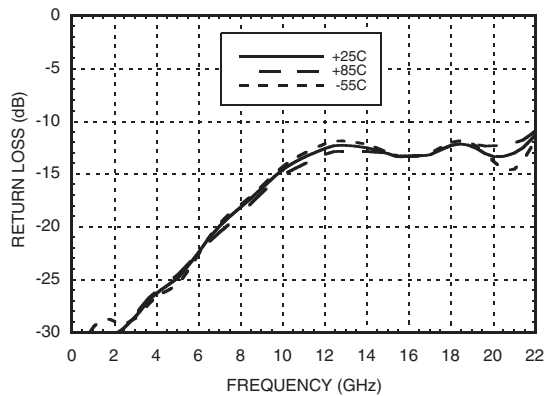

**Output Return Loss vs. Temperature**

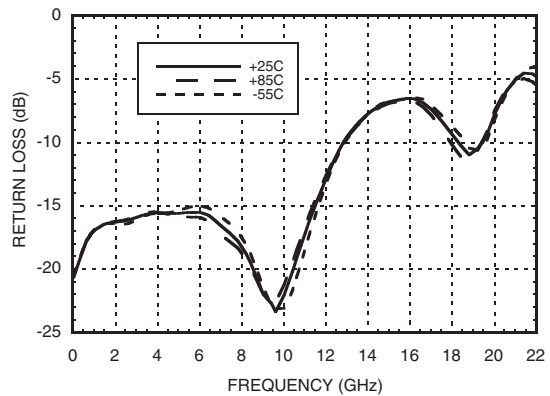

**Reverse Isolation vs. Temperature**

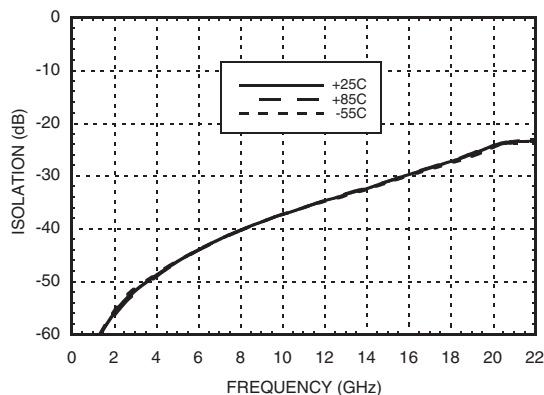

**Noise Figure vs. Temperature**

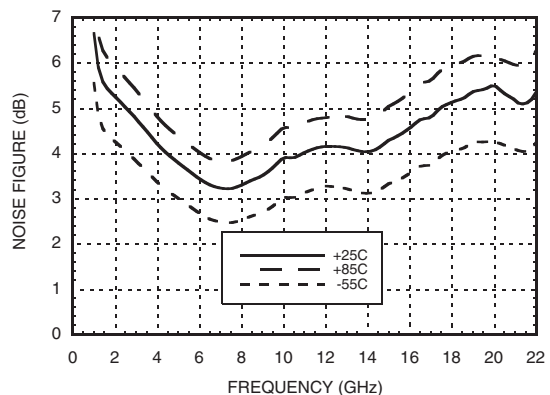

**GaAs PHEMT MMIC  
POWER AMPLIFIER, DC - 20 GHz**

**P1dB vs. Temperature**

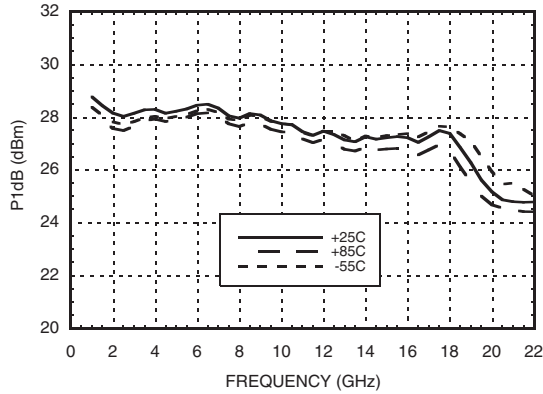

**Psat vs. Temperature**

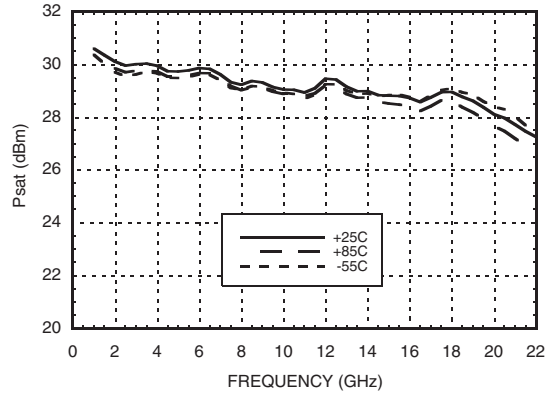

**Output IP3 vs. Temperature**

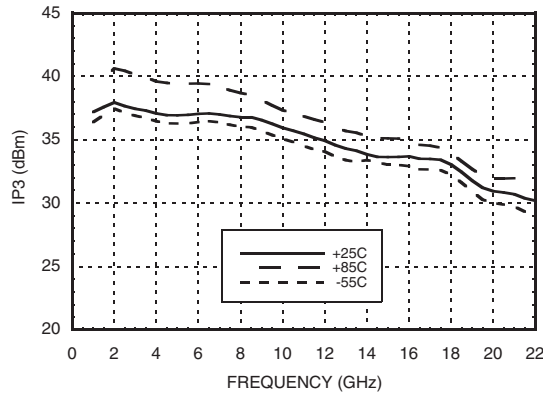

**Output IP3 vs. Output Power**

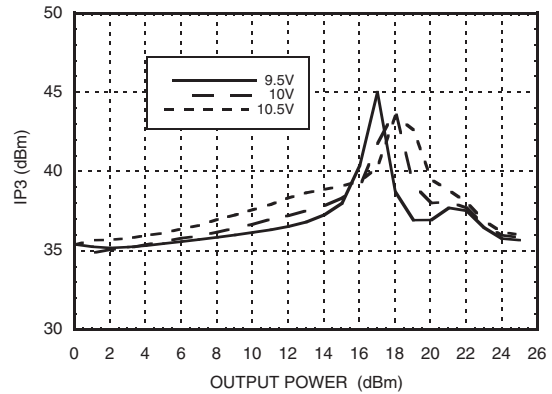

**Gain, Power & Output IP3 vs.  
Supply Voltage @ 10 GHz, Fixed Vgg**

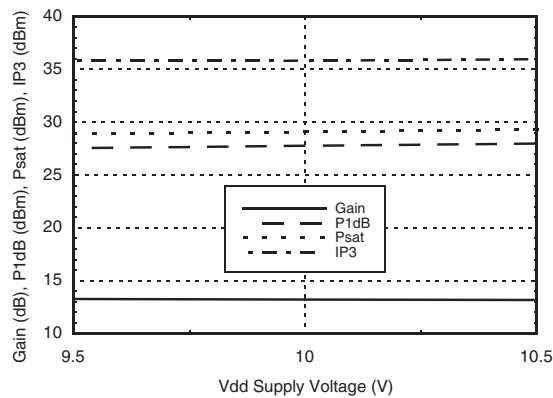

**GaAs PHEMT MMIC  
POWER AMPLIFIER, DC - 20 GHz**

**Power Compression @ 2 GHz**

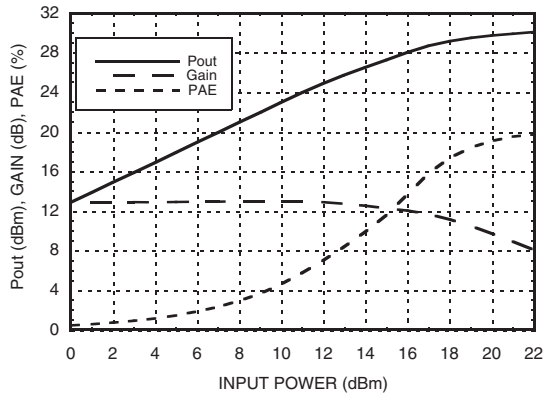

**Power Compression @ 10 GHz**

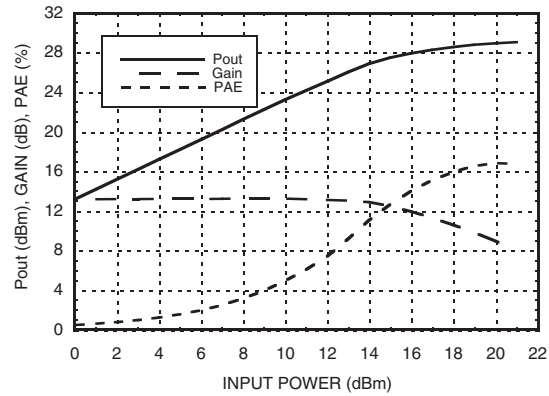

**Power Compression @ 20 GHz**

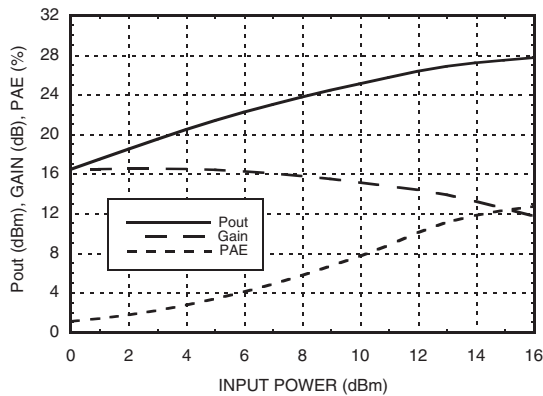

**Power Dissipation**

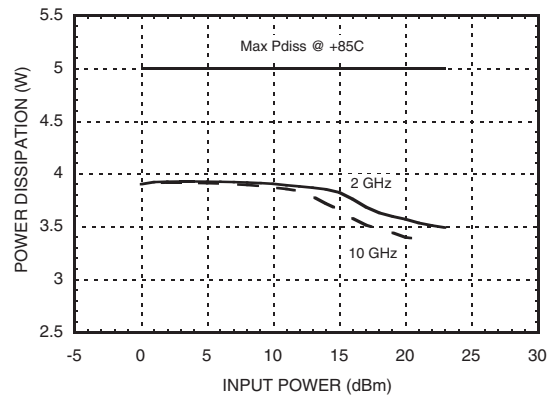

**Absolute Maximum Ratings**

Drain Bias Voltage (Vdd)	+11 Vdc
Gate Bias Voltage (Vgg1)	-2 to 0 Vdc
Gate Bias Voltage (Vgg2)	+3V to +5V
RF Input Power (RFIN)(Vdd = +10 Vdc)	+30 dBm
Channel Temperature	175 °C
Continuous Pdiss (T= 85 °C) (derate 55 mW/°C above 85 °C)	5 W
Thermal Resistance (channel to die bottom)	18 °C/W
Storage Temperature	-65 to +150 °C
Operating Temperature	-55 to +85 °C
ESD Sensitivity (HBM)	Class 1A

**Typical Supply Current vs. Vdd**

Vdd (V)	Idd (mA)
+9.5	399
+10	400
+10.5	401



**ELECTROSTATIC SENSITIVE DEVICE  
OBSERVE HANDLING PRECAUTIONS**

### Outline Drawing

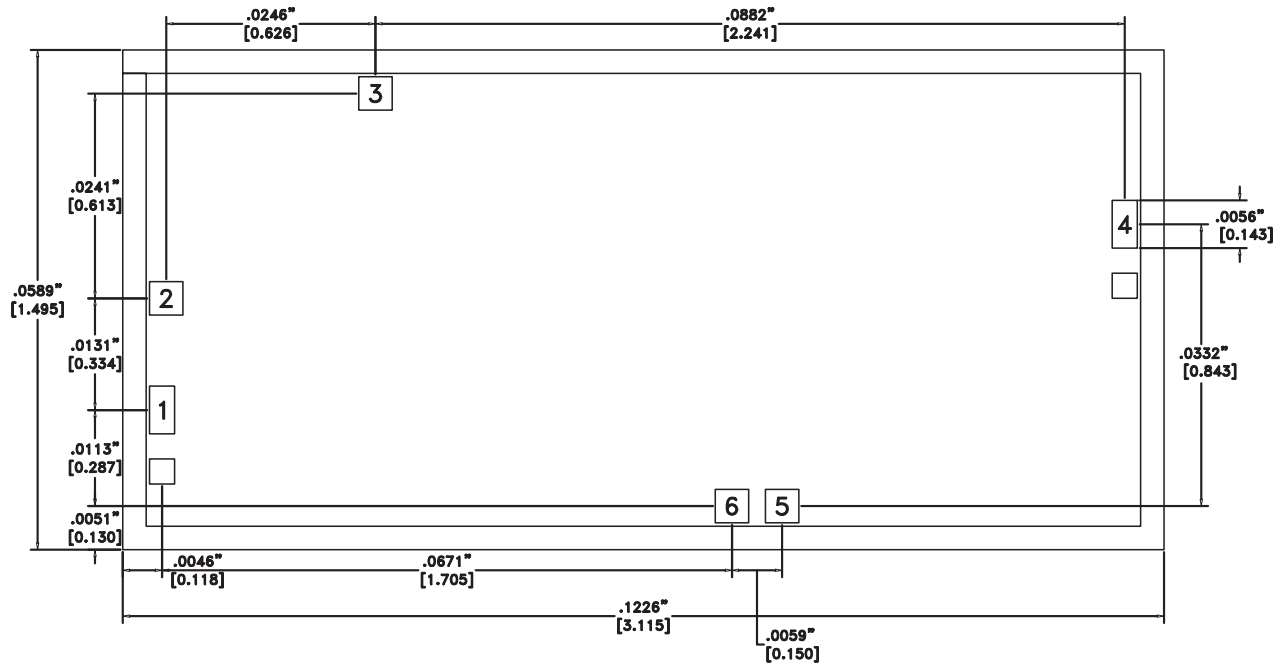

### Die Packaging Information <sup>[1]</sup>

Standard	Alternate
GP-1 (Gel Pack)	[2]

[1] Refer to the "Packaging Information" section for die packaging dimensions.



[2] For alternate packaging information contact Hittite Microwave Corporation.

#### NOTES:

1. ALL DIMENSIONS IN INCHES [MILLIMETERS]
2. DIE THICKNESS IS 0.004 (0.100)
3. TYPICAL BOND PAD IS 0.004 (0.100) SQUARE
4. BOND PAD METALLIZATION: GOLD
5. BACKSIDE METALLIZATION: GOLD
6. BACKSIDE METAL IS GROUND
7. NO CONNECTION REQUIRED FOR UNLABELED BOND PADS
8. OVERALL DIE SIZE IS ±.002

**GaAs PHEMT MMIC  
POWER AMPLIFIER, DC - 20 GHz**

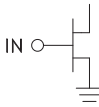
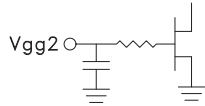
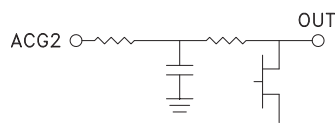
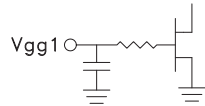
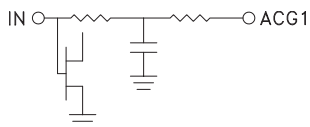
**Pad Descriptions**

Pad Number	Function	Description	Interface Schematic
1	IN	This pad is DC coupled and matched to 50 Ohms. Blocking capacitor is required.	
2	Vgg2	Gate control 2 for amplifier. Attach bypass capacitor per application circuit herein. For nominal operation +4V should be applied to Vgg2.	
3	ACG2	Low frequency termination. Attach bypass capacitor per application circuit herein.	
4	OUT & Vdd	RF output for amplifier. Connect DC bias (Vdd) network to provide drain current (Idd). See application circuit herein.	
5	Vgg1	Gate control 1 for amplifier. Attach bypass capacitor per application circuit herein. Please follow "MMIC Amplifier Biasing Procedure" application note.	
6	ACG1	Low frequency termination. Attach bypass capacitor per application circuit herein.	
Die Bottom	GND	Die bottom must be connected to RF/DC ground.	

**GaAs PHEMT MMIC  
POWER AMPLIFIER, DC - 20 GHz**

**Assembly Diagram**

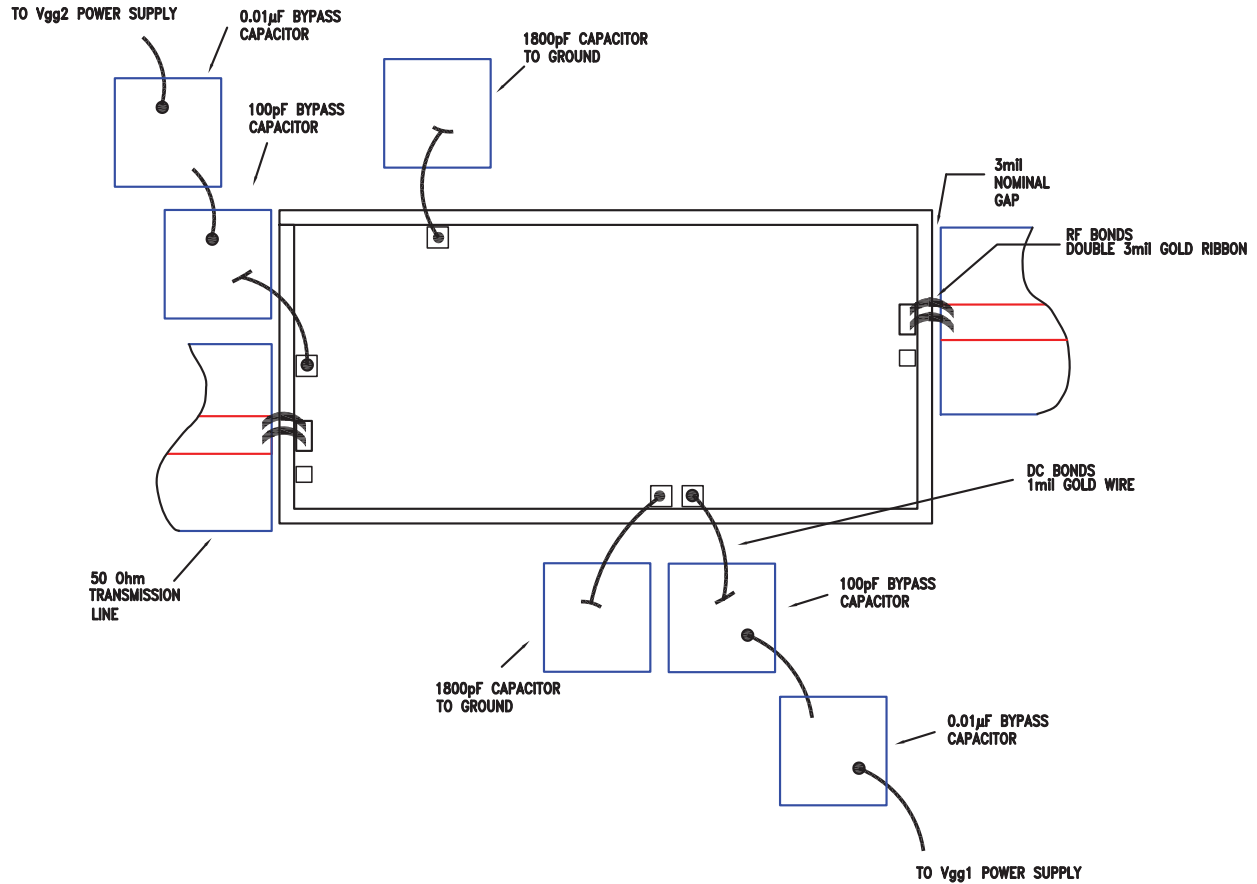

**Application Circuit**

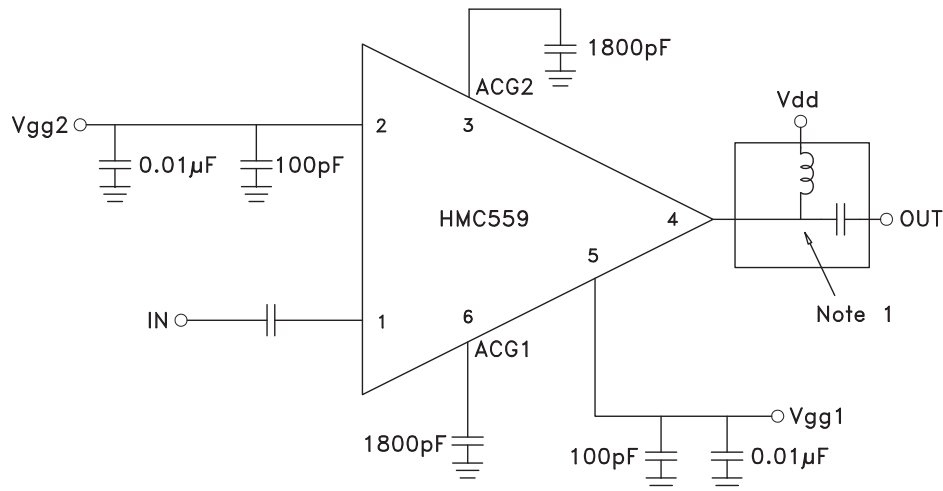

NOTE 1: Drain Bias (V<sub>dd</sub>) must be applied through a broadband bias tee with low series resistance and capable of providing 500mA

### Mounting & Bonding Techniques for Millimeterwave GaAs MMICs

The die should be attached directly to the ground plane eutectically or with conductive epoxy (see HMC general Handling, Mounting, Bonding Note).

50 Ohm Microstrip transmission lines on 0.127mm (5 mil) thick alumina thin film substrates are recommended for bringing RF to and from the chip (Figure 1). If 0.254mm (10 mil) thick alumina thin film substrates must be used, the die should be raised 0.150mm (6 mils) so that the surface of the die is coplanar with the surface of the substrate. One way to accomplish this is to attach the 0.102mm (4 mil) thick die to a 0.150mm (6 mil) thick molybdenum heat spreader (moly-tab) which is then attached to the ground plane (Figure 2).

Microstrip substrates should be placed as close to the die as possible in order to minimize bond wire length. Typical die-to-substrate spacing is 0.076mm to 0.152 mm (3 to 6 mils).

#### Handling Precautions

Follow these precautions to avoid permanent damage.

**Storage:** All bare die are placed in either Waffle or Gel based ESD protective containers, and then sealed in an ESD protective bag for shipment. Once the sealed ESD protective bag has been opened, all die should be stored in a dry nitrogen environment.

**Cleanliness:** Handle the chips in a clean environment. DO NOT attempt to clean the chip using liquid cleaning systems.

**Static Sensitivity:** Follow ESD precautions to protect against ESD strikes.

**Transients:** Suppress instrument and bias supply transients while bias is applied. Use shielded signal and bias cables to minimize inductive pick-up.

**General Handling:** Handle the chip along the edges with a vacuum collet or with a sharp pair of bent tweezers. The surface of the chip may have fragile air bridges and should not be touched with vacuum collet, tweezers, or fingers.

#### Mounting

The chip is back-metallized and can be die mounted with AuSn eutectic preforms or with electrically conductive epoxy. The mounting surface should be clean and flat.

**Eutectic Die Attach:** A 80/20 gold tin preform is recommended with a work surface temperature of 255 °C and a tool temperature of 265 °C. When hot 90/10 nitrogen/hydrogen gas is applied, tool tip temperature should be 290 °C. DO NOT expose the chip to a temperature greater than 320 °C for more than 20 seconds. No more than 3 seconds of scrubbing should be required for attachment.

**Epoxy Die Attach:** Apply a minimum amount of epoxy to the mounting surface so that a thin epoxy fillet is observed around the perimeter of the chip once it is placed into position. Cure epoxy per the manufacturer's schedule.

#### Wire Bonding

RF bonds made with 0.003" x 0.0005" ribbon are recommended. These bonds should be thermosonically bonded with a force of 40-60 grams. DC bonds of 0.001" (0.025 mm) diameter, thermosonically bonded, are recommended. Ball bonds should be made with a force of 40-50 grams and wedge bonds at 18-22 grams. All bonds should be made with a nominal stage temperature of 150 °C. A minimum amount of ultrasonic energy should be applied to achieve reliable bonds. All bonds should be as short as possible, less than 12 mils (0.31 mm).

