



Typical Applications

The HMC527LC4 is ideal for:

- Point-to-Point Radios
- Point-to-Multi-Point Radios & VSAT
- Test Equipment & Sensors
- Military End-Use

Features

- Wide IF Bandwidth: DC - 2 GHz
- Image Rejection: 35 dB
- LO to RF Isolation: 45 dB
- High Input IP3: +28 dBm
- RoHS Compliant 4x4 mm SMT Package

Functional Diagram

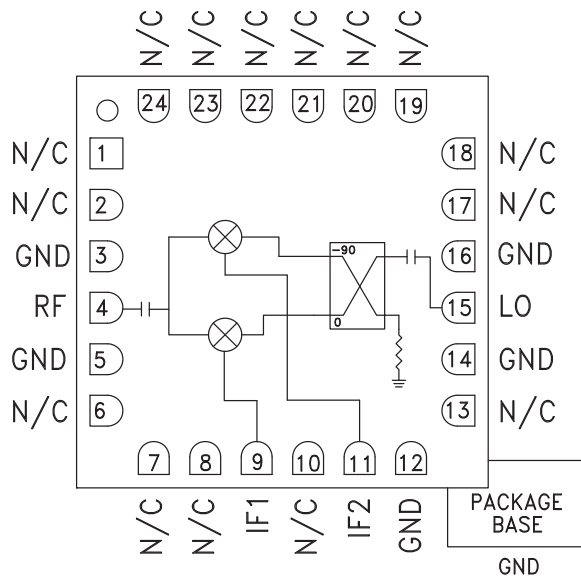

General Description

The HMC527LC4 is a compact general purpose I/Q MMIC mixer in a leadless RoHS compliant SMT package, which can be used as either an Image Reject Mixer or a Single Sideband Upconverter. The mixer utilizes two standard Hittite double balanced mixer cells and a 90 degree hybrid fabricated in a GaAs MESFET process. A low frequency quadrature hybrid was used to produce a 100 MHz USB IF output. This product is a much smaller alternative to hybrid style Image Reject Mixers and Single Sideband Upconverter assemblies. The HMC527LC4 eliminates the need for wire bonding allowing use of surface mount manufacturing techniques.

Electrical Specifications, $T_A = +25^\circ C$, $IF = 100 MHz$, $LO = +19 dBm^*$

Parameter	Min.	Typ.	Max.	Min.	Typ.	Max.	Units
Frequency Range, RF/LO	8.5 - 13.5			10.5 - 12			GHz
Frequency Range, IF	DC - 2			DC - 2			GHz
Conversion Loss (As IRM)		8	10		7.5	9.5	dB
Image Rejection	17	25		27	34		dB
1 dB Compression (Input)		+21			+21		dBm
LO to RF Isolation	37	45		37	45		dB
LO to IF Isolation	17	22		18	24		dB
IP3 (Input)		+25			+28		dBm
Amplitude Balance		0.6			0.4		dB
Phase Balance		6			6		Deg

* Unless otherwise noted, all measurements performed as downconverter.



Data taken as IRM with External IF Hybrid

Conversion Gain vs. Temperature

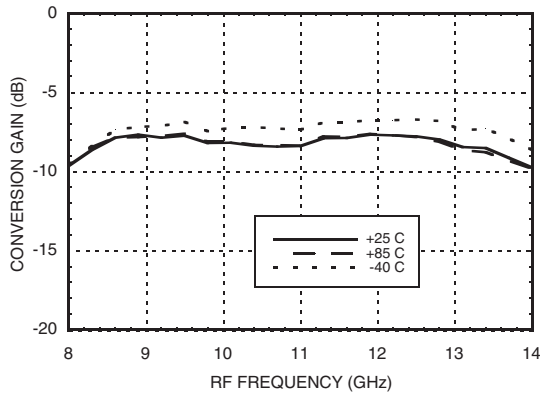
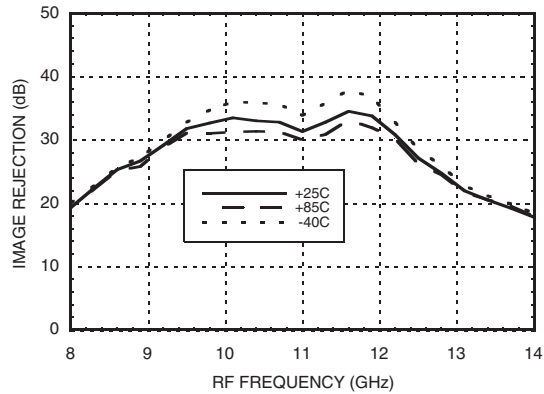
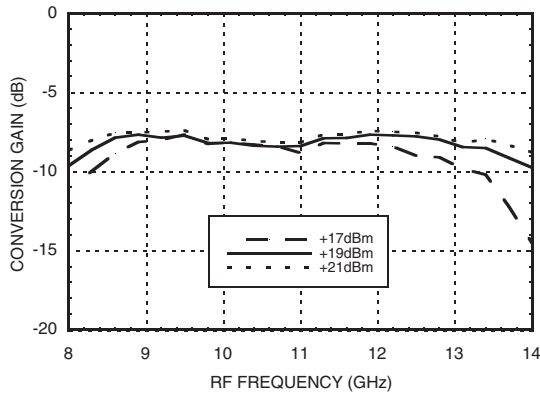

Image Rejection vs. Temperature



Conversion Gain vs. LO Drive



Return Loss

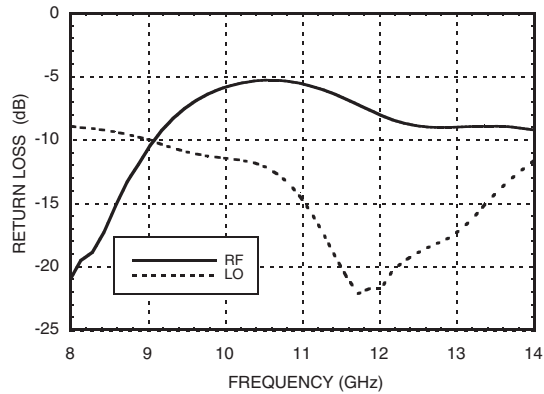

Input P1dB vs. Temperature

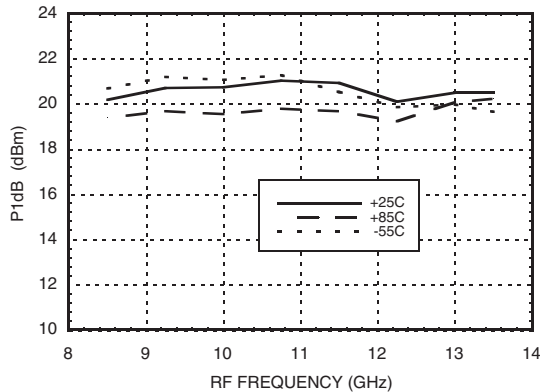

Input IP3 vs. LO Drive

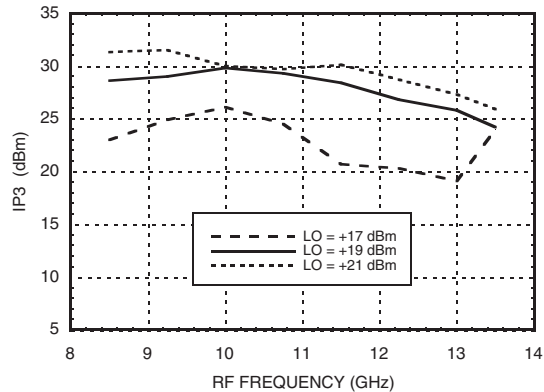

Quadrature Channel Data Taken Without IF Hybrid

Isolations

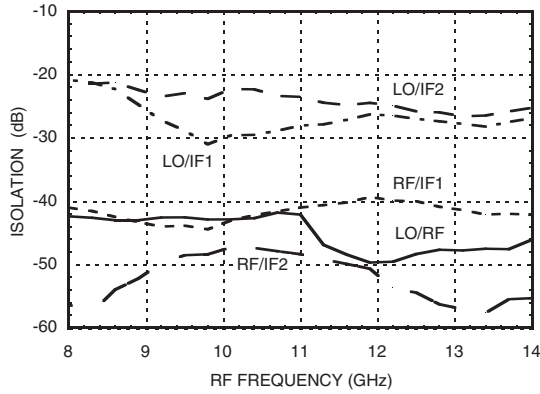

IF Bandwidth*

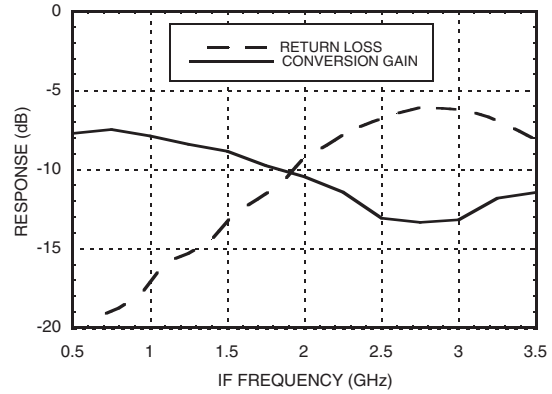

Amplitude Balance vs. LO Drive

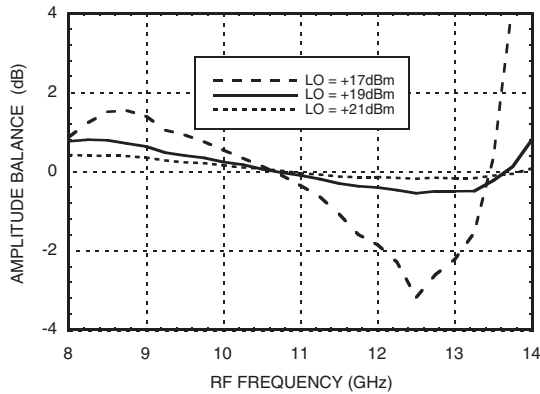

Phase Balance vs. LO Drive

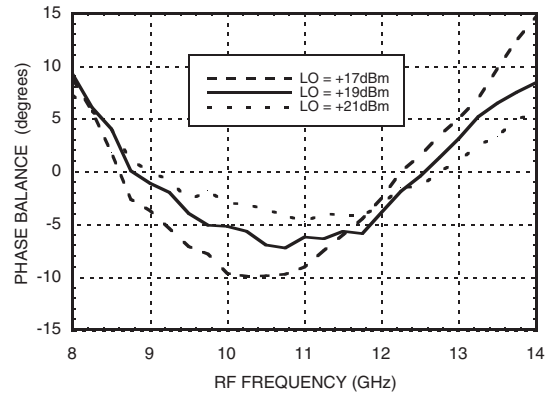

Upconverter Performance Conversion Gain vs. LO Drive*

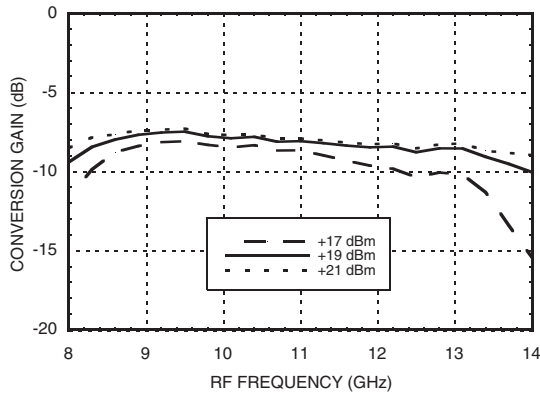

Upconverter Performance Sideband Rejection vs. LO Drive*

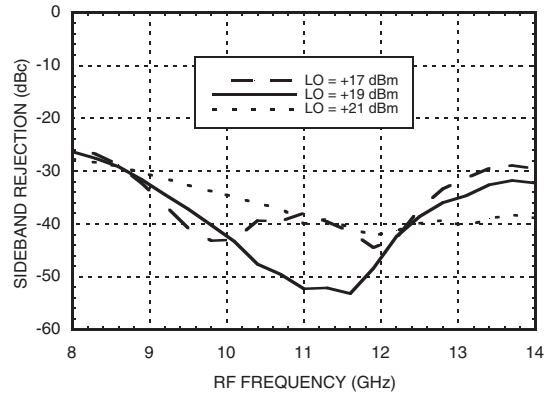

* Conversion gain data taken with external IF hybrid

Harmonics of LO

LO Freq. (GHz)	nLO Spur at RF Port			
	1	2	3	4
8.5	43	48	50	77
9.5	48	47	57	64
10.5	53	51	62	53
11.5	50	57	67	45
12.5	48	52	67	47
13.5	44	51	64	xx

LO = +19 dBm
Values in dBc below input LO level measured at RF Port.

MxN Spurious Outputs

mRF	nLO				
	0	1	2	3	4
0	xx	-11	16	22	38
1	33	0	53	62	95
2	86	77	76	78	94
3	96	95	101	91	102
4	89	94	96	101	107

RF = 10.6 GHz @ -10 dBm
LO = 10.5 GHz @ +19 dBm
Data taken without IF hybrid
All values in dBc below IF power level

Absolute Maximum Ratings

RF / IF Input	+20 dBm
LO Drive	+27 dBm
Channel Temperature	150°C
Continuous P _{diss} (T=85°C) (derate 7.1 mW/°C above 85°C)	460 mW
Thermal Resistance (R _{th}) (junction to die bottom)	140 °C/W
Storage Temperature	-65 to +150 °C
Operating Temperature	-40 to +85 °C



**ELECTROSTATIC SENSITIVE DEVICE
OBSERVE HANDLING PRECAUTIONS**

NOTES:

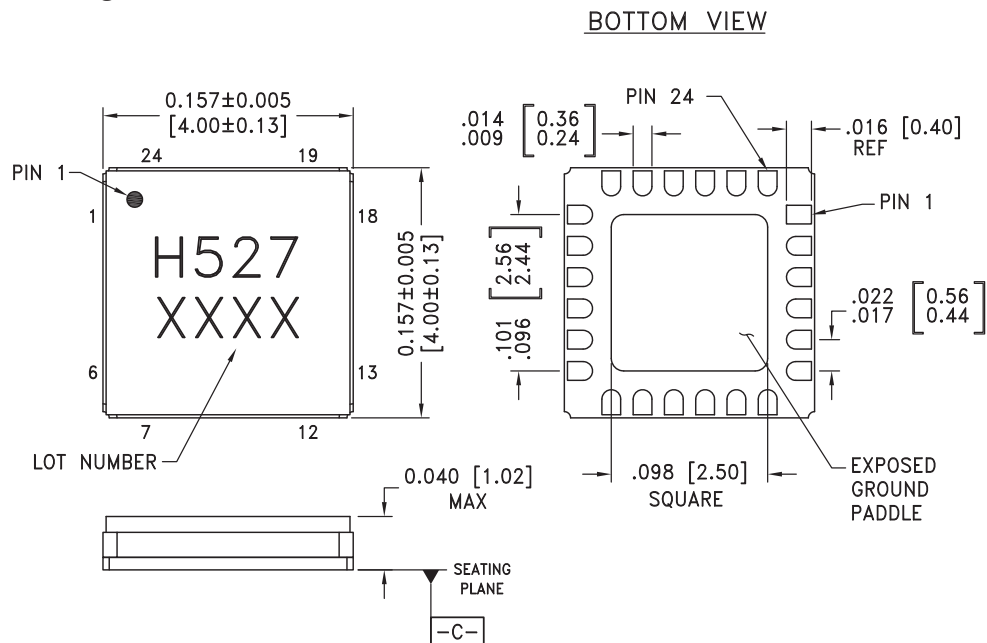

- PACKAGE BODY MATERIAL: ALUMINA
- LEAD AND GROUND PADDLE PLATING: 30 - 80 MICROINCHES GOLD OVER 50 MICROINCHES MINIMUM NICKLE
- DIMENSIONS ARE IN INCHES [MILLIMETERS]
- LEAD SPACING TOLERANCE IS NON-CUMULATIVE
- PACKAGE WARP SHALL NOT EXCEED 0.05mm DATUM
- ALL GROUND LEADS AND GROUND PADDLE MUST BE SOLDERED TO PCB RF GROUND
- CLASSIFIED AS A MOISTURE SENSITIVITY LEVEL (MSL) 1.

Outline Drawing



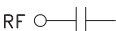
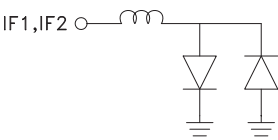

Pin Descriptions

Pin Number	Function	Description	Interface Schematic
1, 2, 6-8, 10, 13, 17-24	N/C	No connection required. These pins may be connected to RF/DC ground without affecting performance.	
3, 5, 12, 14, 16	GND	These pins and package bottom must be connected to RF/DC ground.	
4	RF	This pin is AC coupled and matched to 50 Ohms from 8.5 to 13.5 GHz.	
9	IF1	This pin is DC coupled. For applications not requiring operation to DC, this port should be DC blocked externally using a series capacitor whose value has been chosen to pass the necessary IF frequency range. For operation to DC, this pin must not source/sink more than 3mA of current or part non-function and possible part failure will result.	
11	IF2		
15	LO	This pin is AC coupled and matched to 50 Ohms from 8.5 to 13.5 GHz.	

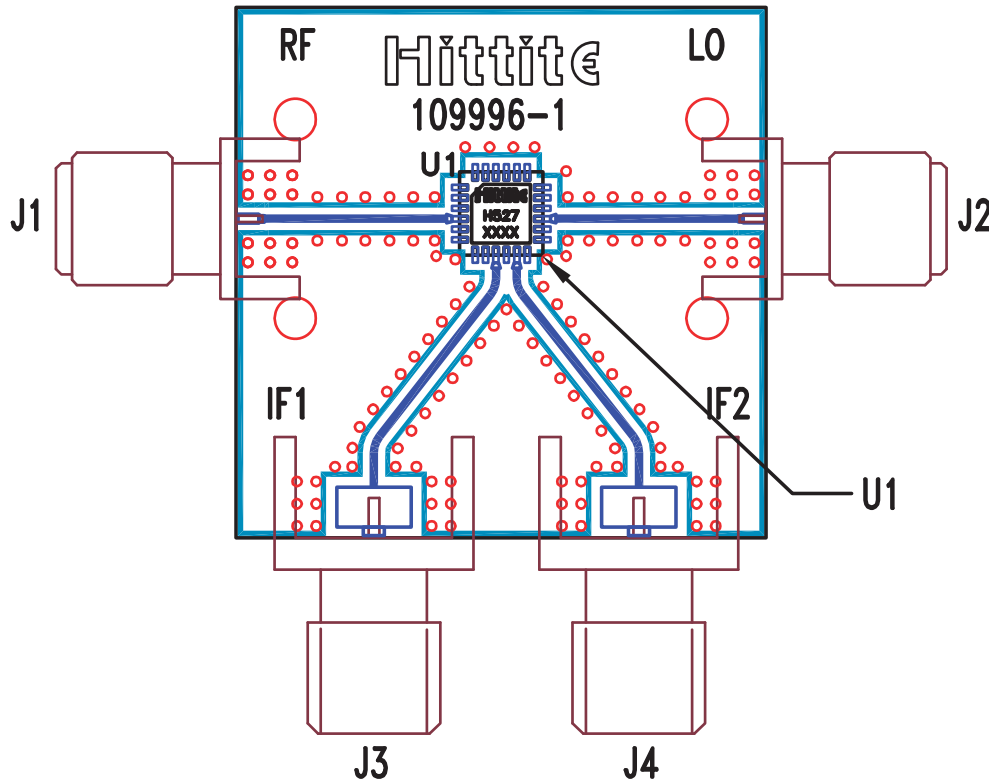
Evaluation PCB

List of Materials for Evaluation PCB 109998 [1]

Item	Description
J1 - J2	PCB Mount K RF Connector, SRI
J3 - J4	PCB Mount SMA Connector, Johnson
U1	HMC527LC4
PCB [2]	109996 Evaluation Board

[1] Reference this number when ordering complete evaluation PCB

[2] Circuit Board Material: Rogers 4350

The circuit board used in the final application should use RF circuit design techniques. Signal lines should have 50 ohm impedance while the package ground leads and exposed paddle should be connected directly to the ground plane similar to that shown. A sufficient number of via holes should be used to connect the top and bottom ground planes. The evaluation circuit board shown is available from Hittite upon request.