



GaAs PHEMT MMIC LOW NOISE AMPLIFIER, 18 - 31 GHz

Typical Applications

The HMC519LC4 is ideal for:

- Point-to-Point Radios
- Point-to-Multi-Point Radios & VSAT
- Test Equipment & Sensors
- Military & Space

Features

- Noise Figure: 3.5 dB
- Gain: 14 dB
- Output IP3: +23 dBm
- Single Supply: +3V @ 75 mA
- 50 Ohm Matched Input/Output
- 24 Lead Ceramic 4x4mm SMT Package: 16mm²

Functional Diagram

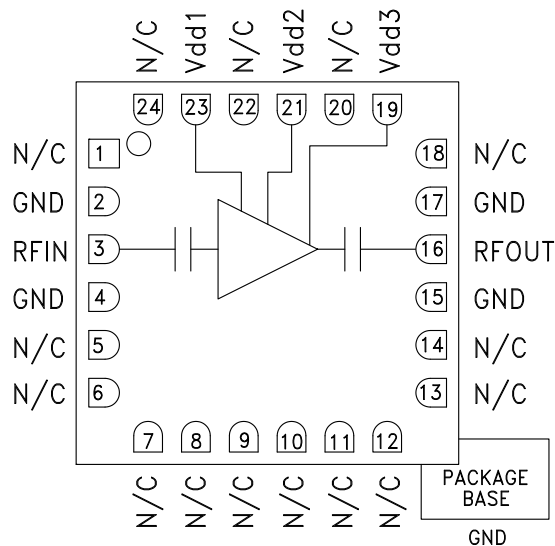

General Description

The HMC519LC4 is a high dynamic range GaAs pHEMT MMIC Low Noise Amplifier (LNA) housed in a leadless 4 x 4 mm ceramic surface mount package. The amplifier operates between 18 and 31 GHz, providing 14 dB of small signal gain, 3.5 dB noise figure and output IP3 of +23 dBm, while requiring only 75 mA from a +3V single supply. The P1dB output power of +11 dBm, enables the LNA to function as a LO driver for balanced, I/Q or image reject mixers. The HMC519LC4 also features I/Os that are DC blocked and internally matched to 50 Ohms, making it ideal for microwave radio and VSAT applications.

Electrical Specifications, $T_A = +25^\circ\text{C}$, $V_{dd\ 1, 2, 3} = +3V$

Parameter	Min.	Typ.	Max.	Min.	Typ.	Max.	Units
Frequency Range	18 - 28		28 - 31				GHz
Gain	11.4	14.4		10.2	13.2		dB
Gain Variation Over Temperature		0.016	0.026		0.016	0.026	dB/°C
Noise Figure		3.5	5.5		3	5	dB
Input Return Loss		15			17		dB
Output Return Loss		20			22		dB
Output Power for 1 dB Compression (P1dB)	8	11		9.2	12.2		dBm
Saturated Output Power (P _{sat})		14			15.4		dBm
Output Third Order Intercept (IP3)		23			24		dBm
Supply Current (I _{dd})		75	95		75	95	mA



GaAs PHEMT MMIC LOW NOISE AMPLIFIER, 18 - 31 GHz

Broadband Gain & Return Loss

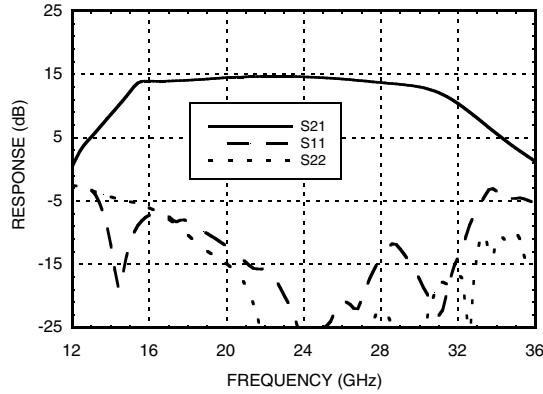

Gain vs. Temperature

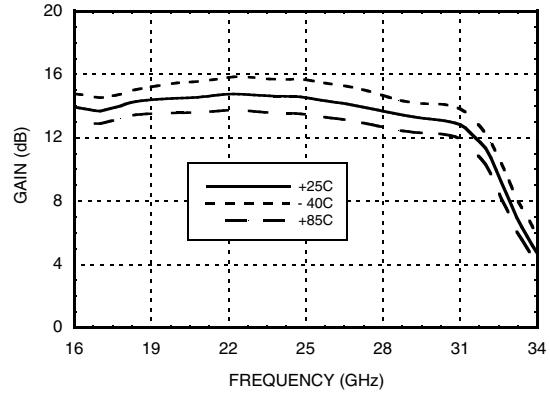

Input Return Loss vs. Temperature

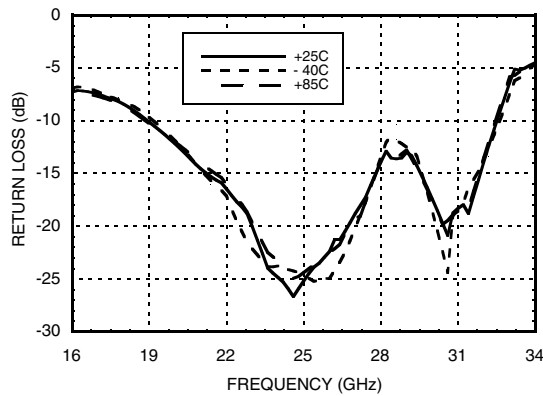

Output Return Loss vs. Temperature

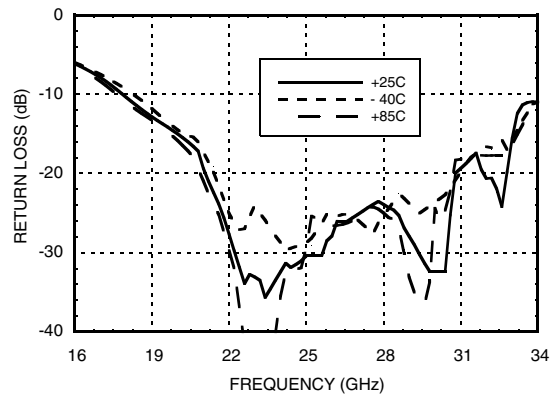

Noise Figure vs. Temperature

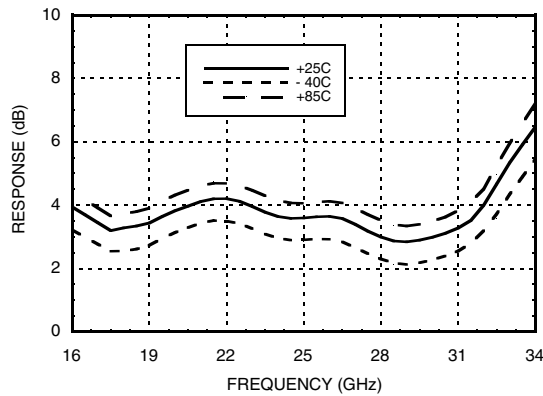

Output IP3 vs. Temperature

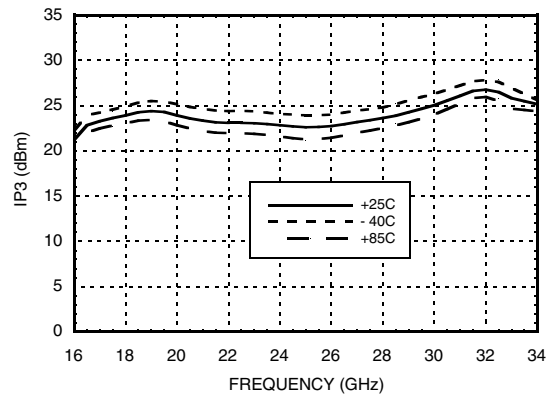

Information furnished by Analog Devices is believed to be accurate and reliable. However, no responsibility is assumed by Analog Devices for its use, nor for any infringements of patents or other rights of third parties that may result from its use. Specifications subject to change without notice. No license is granted by implication or otherwise under any patent or patent rights of Analog Devices. Trademarks and registered trademarks are the property of their respective owners.

For price, delivery, and to place orders: Analog Devices, Inc., One Technology Way, P.O. Box 9106, Norwood, MA 02062-9106 Phone: 781-329-4700 • Order online at www.analog.com Application Support: Phone: 1-800-ANALOG-D



GaAs PHEMT MMIC LOW NOISE AMPLIFIER, 18 - 31 GHz

LOW NOISE AMPLIFIERS - SMT

P1dB vs. Temperature

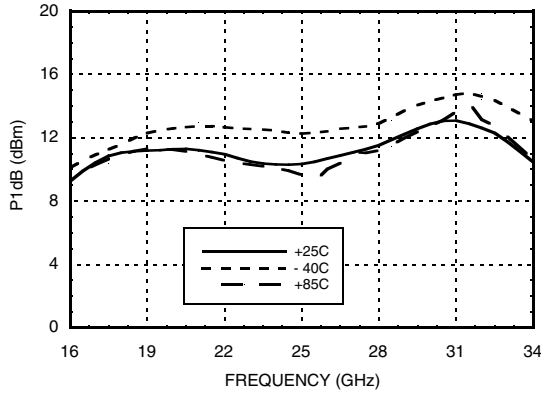

Psat vs. Temperature

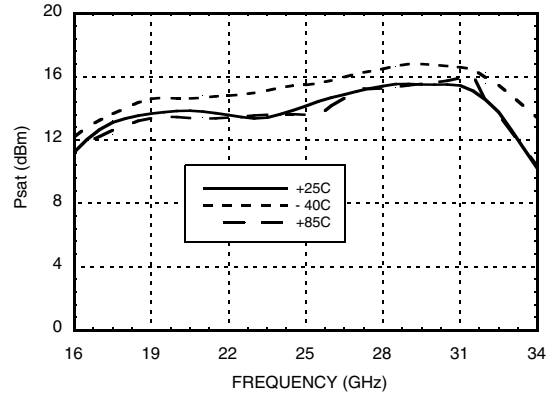

Reverse Isolation vs. Temperature

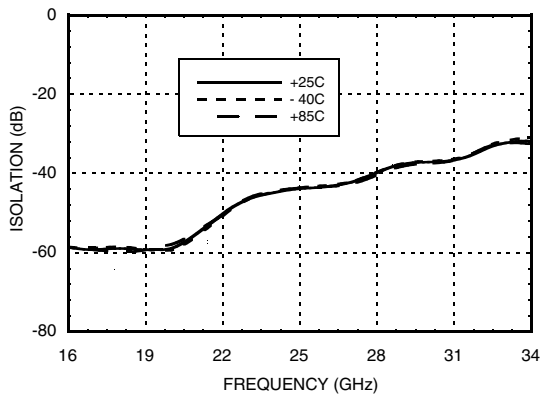

Power Compression @ 24 GHz

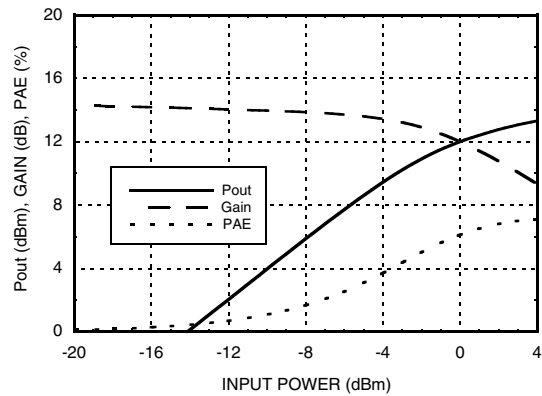

Gain, Noise Figure & Power vs. Supply Voltage @ 24 GHz

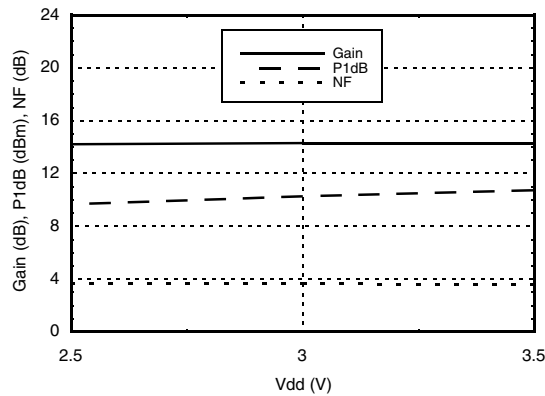

Information furnished by Analog Devices is believed to be accurate and reliable. However, no responsibility is assumed by Analog Devices for its use, nor for any infringements of patents or other rights of third parties that may result from its use. Specifications subject to change without notice. No license is granted by implication or otherwise under any patent or patent rights of Analog Devices. Trademarks and registered trademarks are the property of their respective owners.

For price, delivery, and to place orders: Analog Devices, Inc., One Technology Way, P.O. Box 9106, Norwood, MA 02062-9106 Phone: 781-329-4700 • Order online at www.analog.com Application Support: Phone: 1-800-ANALOG-D



GaAs PHEMT MMIC LOW NOISE AMPLIFIER, 18 - 31 GHz

Absolute Maximum Ratings

Drain Bias Voltage (Vdd1, Vdd2, Vdd3)	+3.5 Vdc
RF Input Power (RFIN)(Vdd = +3.0 Vdc)	+8 dBm
Channel Temperature	175 °C
Continuous Pdiss (T= 85 °C) (derate 12 mW/°C above 85 °C)	1.08 W
Thermal Resistance (channel to package bottom)	83 °C/W
Storage Temperature	-65 to 150 °C
Operating Temperature	-40 to 85 °C
ESD Sensitivity (HBM)	Class 1B

Typical Supply Current vs. Vdd

Vdd (V)	Idd (mA)
2.5	72
3.0	75
3.5	78

Note: Amplifier will operate over full voltage ranges shown above.



ELECTROSTATIC SENSITIVE DEVICE
OBSERVE HANDLING PRECAUTIONS

Outline Drawing

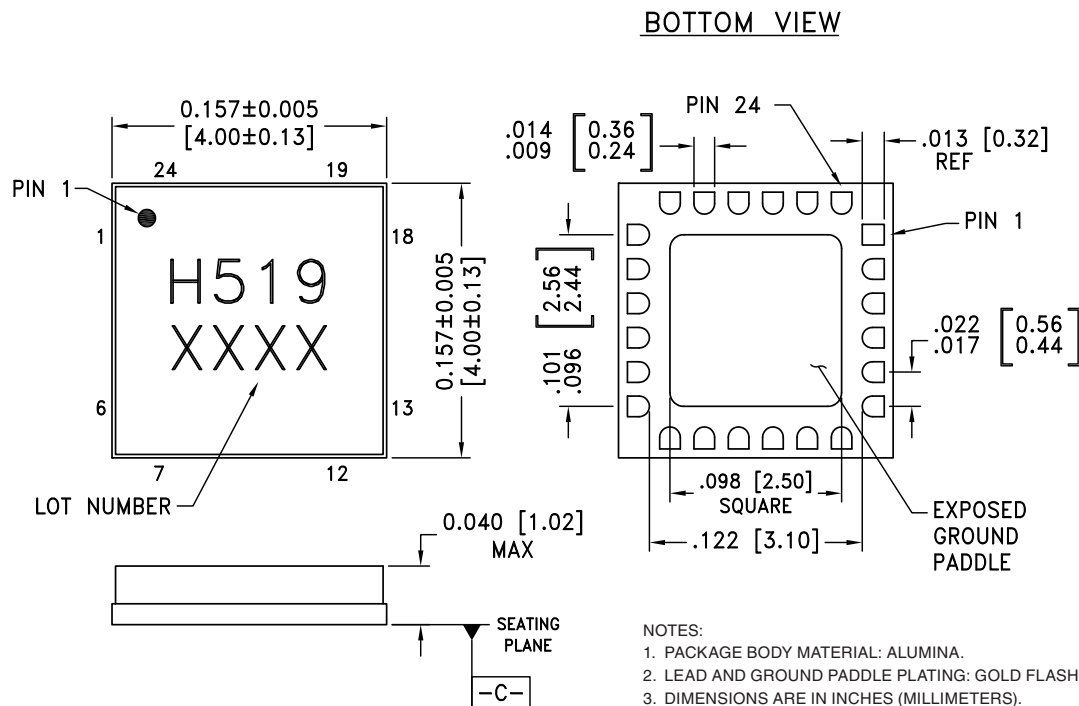

NOTES:

- PACKAGE BODY MATERIAL: ALUMINA.
- LEAD AND GROUND PADDLE PLATING: GOLD FLASH OVER NICKEL.
- DIMENSIONS ARE IN INCHES (MILLIMETERS).
- LEAD SPACING TOLERANCE IS NON-CUMULATIVE.
- PACKAGE WARP SHALL NOT EXCEED 0.05MM DATUM -C-
- ALL GROUND LEADS AND GROUND PADDLE MUST BE SOLDERED TO PCB RF GROUND.

Package Information

Part Number	Package Body Material	Lead Finish	MSL Rating	Package Marking ^[2]
HMC519LC4	Alumina, White	Gold over Nickel	MSL3 ^[1]	H519 XXXX

[1] Max peak reflow temperature of 260 °C

[2] 4-Digit lot number XXXX



GaAs PHEMT MMIC LOW NOISE AMPLIFIER, 18 - 31 GHz

Pad Descriptions

Pad Number	Function	Description	Interface Schematic
1, 5 - 14, 18, 20, 22, 24	N/C	Not Connected	
2, 4, 15, 17	GND	Package bottom has exposed metal paddle that must be connected to RF/DC ground.	
3	RFIN	This pad is AC coupled and matched to 50 Ohms	
16	RFOUT	This pad is AC coupled and matched to 50 Ohms	
19, 21, 23	Vdd3, Vdd2, Vdd1	Power Supply Voltage for the amplifier. See application circuit for required external components.	

Application Circuit

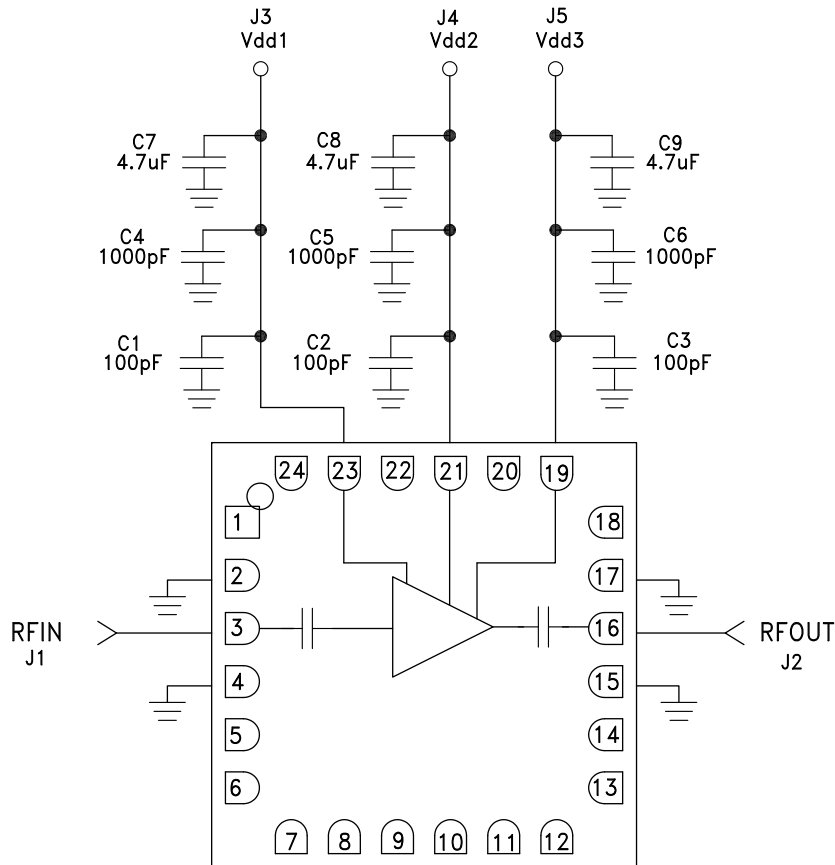

Information furnished by Analog Devices is believed to be accurate and reliable. However, no responsibility is assumed by Analog Devices for its use, nor for any infringements of patents or other rights of third parties that may result from its use. Specifications subject to change without notice. No license is granted by implication or otherwise under any patent or patent rights of Analog Devices. Trademarks and registered trademarks are the property of their respective owners.

For price, delivery, and to place orders: Analog Devices, Inc., One Technology Way, P.O. Box 9106, Norwood, MA 02062-9106 Phone: 781-329-4700 • Order online at www.analog.com Application Support: Phone: 1-800-ANALOG-D

**GaAs PHEMT MMIC LOW NOISE
AMPLIFIER, 18 - 31 GHz**



Evaluation PCB

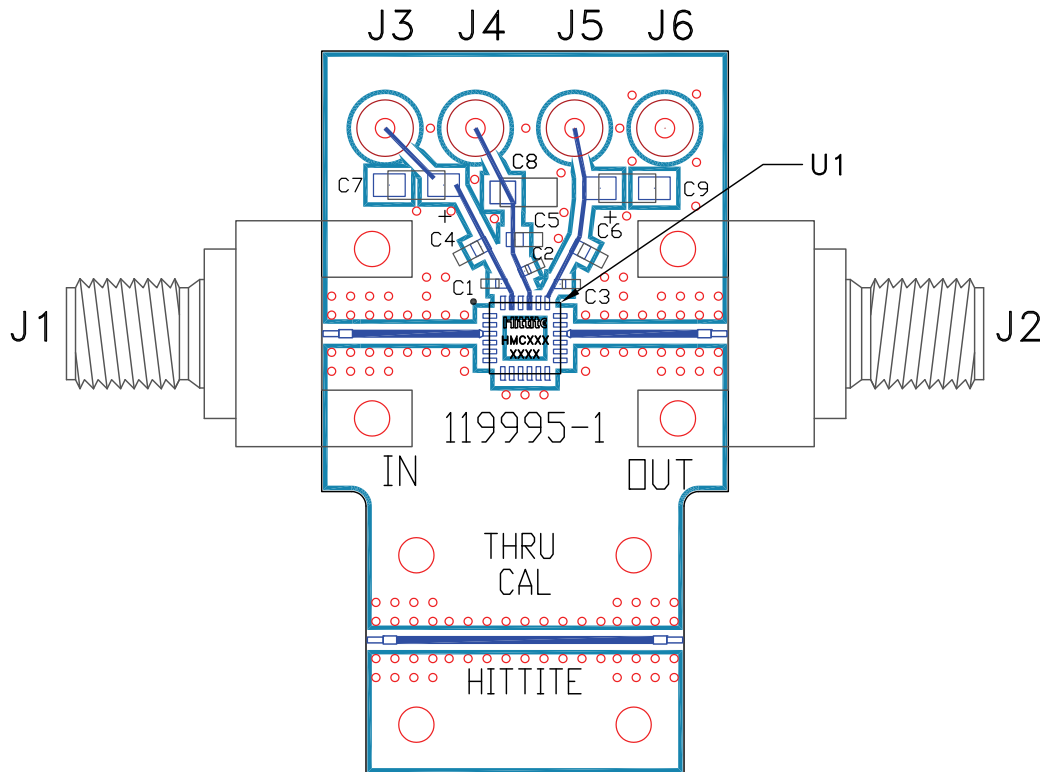

List of Material for Evaluation PCB 119667 [1]

Item	Description
J1, J2	2.92mm PCB mount K-Connector
J3 - J6	DC Pin
C1, C2, C3	100pF Capacitor, 0402 Pkg.
C4, C5, C6	1000pF Capacitor, 0603 Pkg.
C7, C8, C9	4.7 μ F Capacitor, Tantalum
U1	HMC519LC4 Amplifier
PCB [2]	11995 Evaluation PCB

[1] Reference this number when ordering complete evaluation PCB

[2] Circuit Board Material: Rogers 4350.

The circuit board used in this application should use RF circuit design techniques. Signal lines should have 50 Ohm impedance while the package ground leads and exposed paddle should be connected directly to the ground plane similar to that shown. A sufficient number of via holes should be used to connect the top and bottom ground planes. The evaluation board should be mounted to an appropriate heat sink. The evaluation circuit board shown is available from Hittite upon request.