

### Typical Applications

This amplifier is ideal for use as a power amplifier for 3.3 - 3.8 GHz applications:

- WiMAX 802.16
- Fixed Wireless Access
- Wireless Local Loop

### Functional Diagram

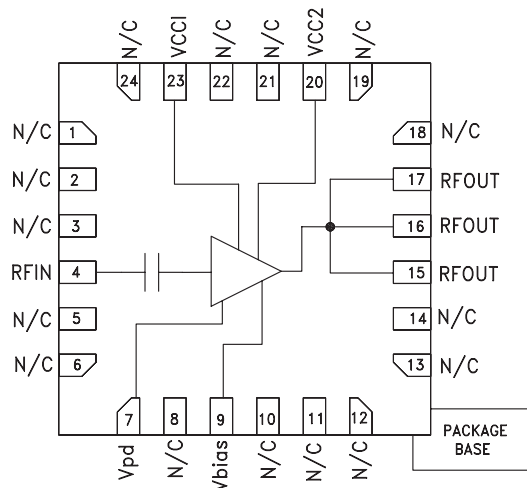

### Features

- Gain: 31 dB
- 40% PAE @ +32.5 dBm pout
- 2% EVM @ Pout = +22 dBm with 54Mbps OFDM Signal
- +46 dBm Output IP3
- Integrated Power Control (Vpd)
- Single +5V Supply

### General Description

The HMC409LP4 & HMC409LP4E are high efficiency GaAs InGaP HBT MMIC Power amplifiers operating from 3.3 to 3.8 GHz. The amplifier is packaged in a low cost, leadless SMT package. Utilizing a minimum of external components the amplifier provides 31 dB of gain and +32.5 dBm of saturated power from a +5.0V supply voltage. The power control (Vpd) can be used for full power down or RF output power/current control. For +22 dBm OFDM output power (64 QAM, 54 Mbps), the HMC409LP4 & HMC409LP4E achieve an error vector magnitude (EVM) of 2%, meeting WiMAX 802.16 linearity requirements.

### Electrical Specifications, $T_A = +25^\circ C$ , $V_s = +5V$ , $V_{pd} = +5V$ , $V_{bias} = +5V$

Parameter	Min.	Typ.	Max.	Min.	Typ.	Max.	Min.	Typ.	Max.	Units
Frequency Range	3.3 - 3.4			3.4 - 3.6			3.6 - 3.8			GHz
Gain	30	32		29	31.5		28	30		dB
Gain Variation Over Temperature		0.04	0.05		0.04	0.05		0.035	0.045	dB/ °C
Input Return Loss		10			15			15		dB
Output Return Loss		13			14			10		dB
Output Power for 1dB Compression (P1dB)	28	30		28	30.5		28	30.5		dBm
Saturated Output Power (Psat)		32			32.5			32		dBm
Output Third Order Intercept (IP3) [2]	41	45		42	45.5		41	45		dBm
Error Vector Magnitude @ 3.5 GHz (54 Mbps OFDM Signal @ +22 dBm Pout)					2					%
Noise Figure		5.8			5.8			6		dB
Supply Current (Icq) $V_s = V_{cc1} + V_{cc2} = +5V$		615			615			615		mA
Control Current (Ipd) $V_{pd} = +5V$		4			4			4		mA
Switching Speed $t_{On}, t_{Off}$		20			20			20		ns
Bias Current (Ibias)		10			10			10		mA

Note 1: Specifications and data reflect HMC409LP4 measured using the application circuit found herein. Contact the HMC Applications Group for assistance in optimizing performance for your application.

Note 2: Two-tone output power of +15 dBm per tone, 1 MHz spacing.



**Broadband Gain & Return Loss**

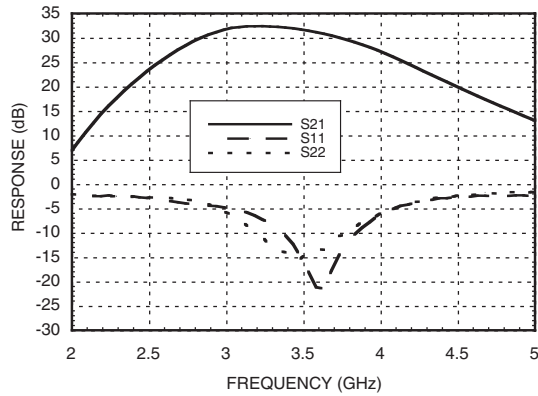

**Gain vs. Temperature**

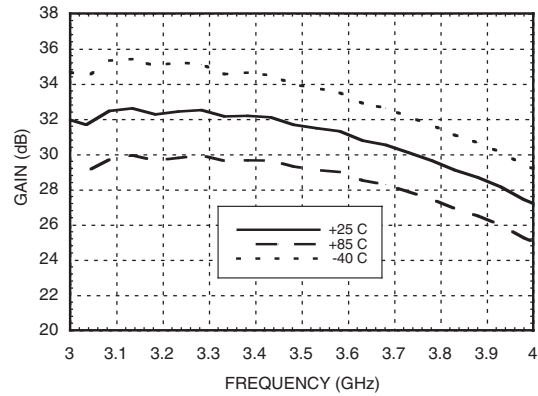

**Input Return Loss vs. Temperature**

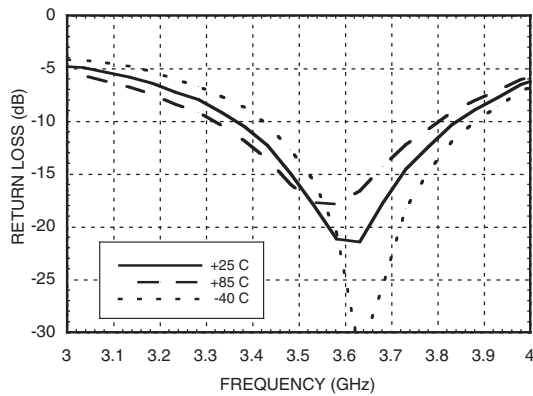

**Output Return Loss vs. Temperature**

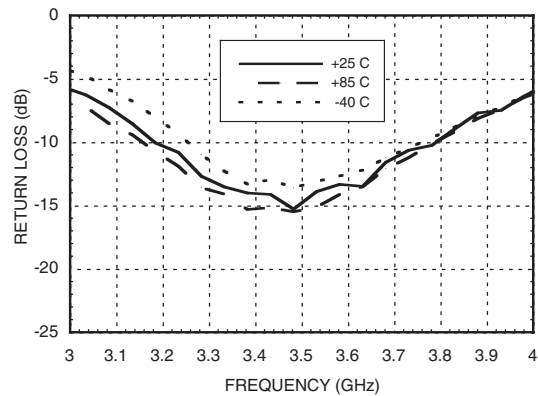

**Reverse Isolation vs. Temperature**

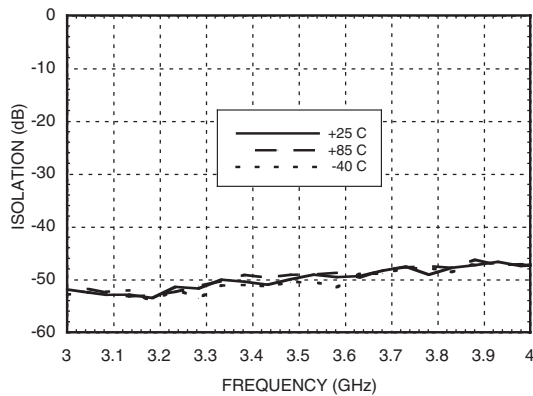

**Power Down Isolation vs. Temperature**

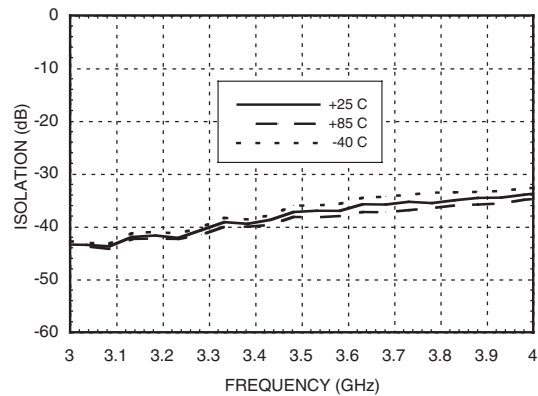



**P1dB vs. Temperature**

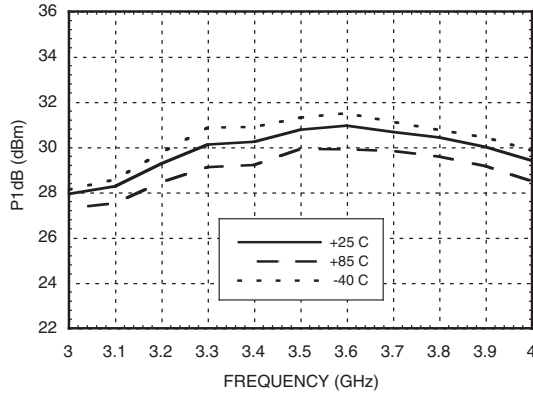

**Psat vs. Temperature**

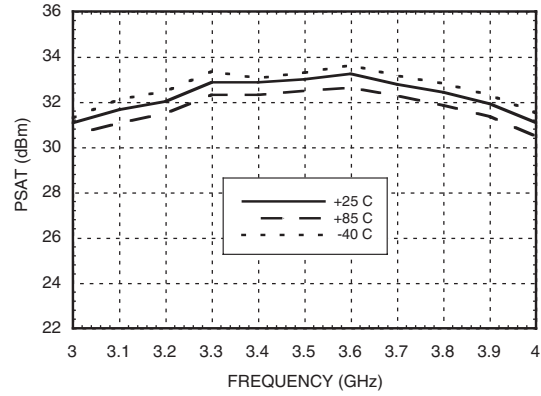

**Output IP3 vs. Temperature**

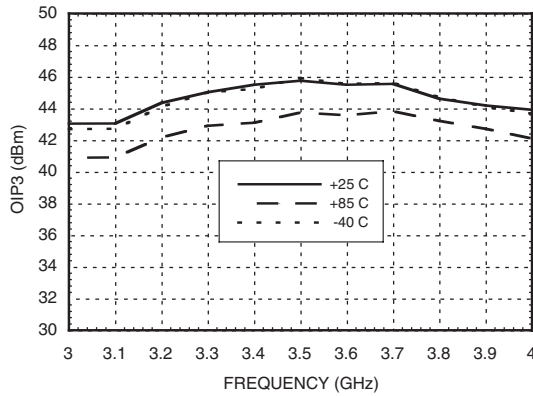

**Power Compression @ 3.5GHz**

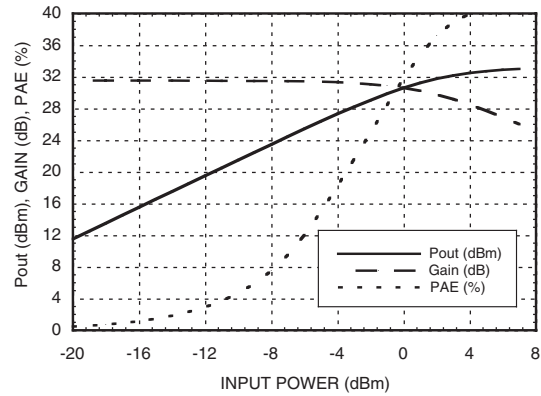

**Gain & Power vs. Supply Voltage**

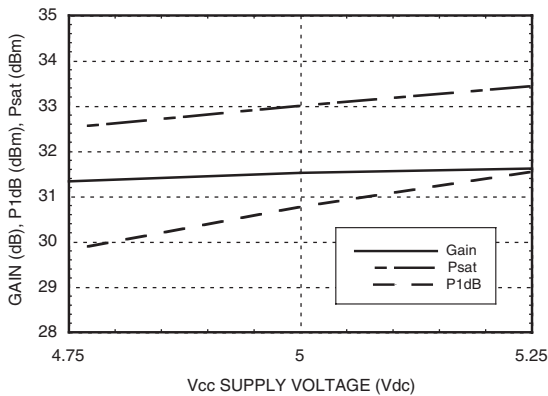

**Noise Figure vs. Temperature**

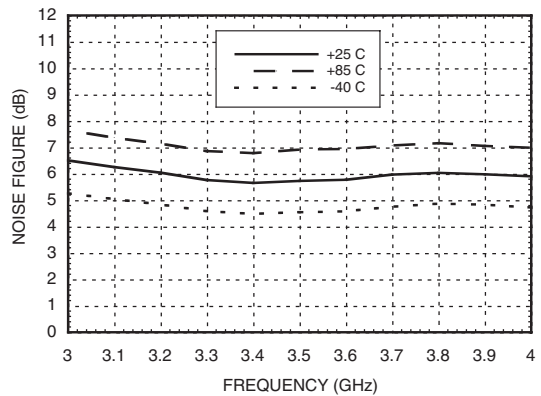



**Gain, Power & Quiescent  
Supply Current vs. Vpd @ 3.5 GHz**

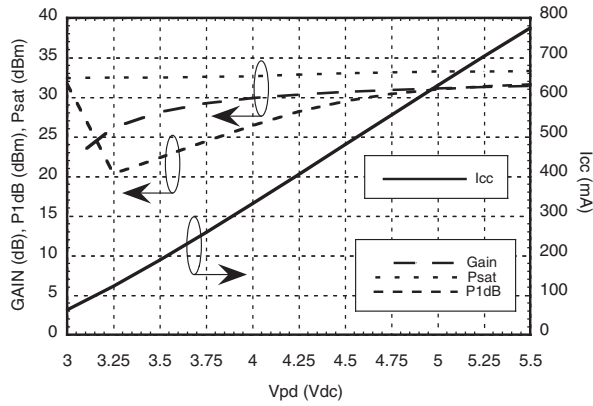

**Power Dissipation**

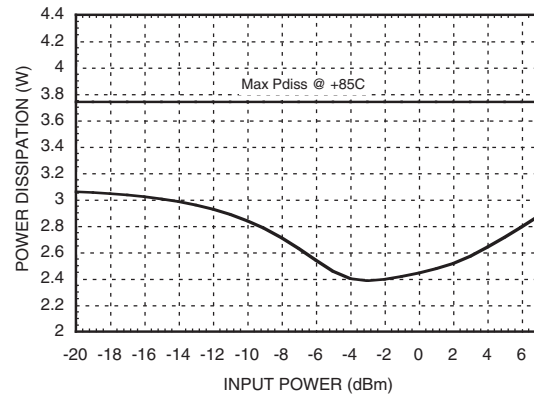

**EVM vs. Temperature @ 3.5 GHz OFDM  
54 Mbps Signal**

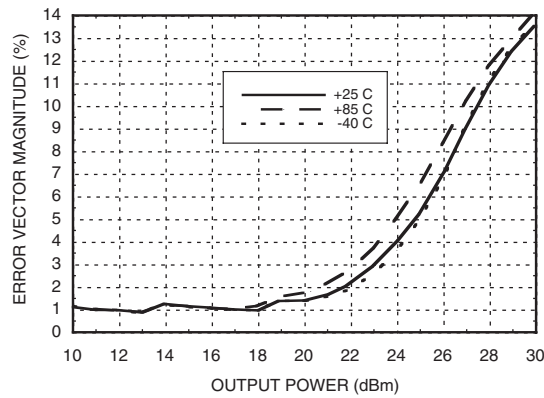

### Absolute Maximum Ratings

Collector Bias Voltage (Vcc1, Vcc2)	+5.5 Vdc
Control Voltage (Vpd)	+5.5 Vdc
RF Input Power (RFIn)(Vs = Vpd = +5.0 Vdc)	+10 dBm
Junction Temperature	150 °C
Continuous Pdiss (T = 85 °C) (derate 57.5 mW/°C above 85 °C)	3.74 W
Thermal Resistance (junction to ground paddle)	17.4 °C/W
Storage Temperature	-65 to +150 °C
Operating Temperature	-40 to +85 °C

### Typical Supply, Current vs. Supply Voltage, Vcc1 = Vcc2 = Vpd

Vs (Vdc)	Icq (mA)
4.75	516
5.0	615
5.25	721



ELECTROSTATIC SENSITIVE DEVICE  
OBSERVE HANDLING PRECAUTIONS

### Outline Drawing

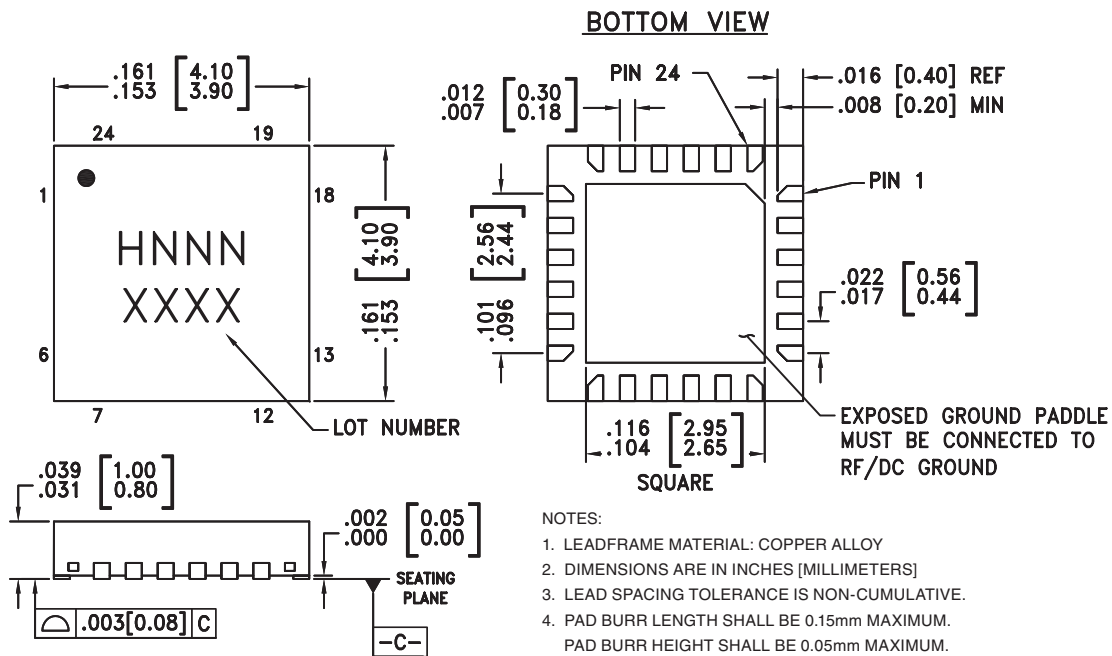

NOTES:

- LEADFRAME MATERIAL: COPPER ALLOY
- DIMENSIONS ARE IN INCHES [MILLIMETERS]
- LEAD SPACING TOLERANCE IS NON-CUMULATIVE.
- PAD BURR LENGTH SHALL BE 0.15mm MAXIMUM.  
PAD BURR HEIGHT SHALL BE 0.05mm MAXIMUM.
- PACKAGE WARP SHALL NOT EXCEED 0.05mm.
- ALL GROUND LEADS AND GROUND PADDLE MUST BE SOLDERED TO PCB RF GROUND.
- REFER TO HITTITE APPLICATION NOTE FOR SUGGESTED LAND PATTERN.

### Package Information

Part Number	Package Body Material	Lead Finish	MSL Rating	Package Marking <sup>[3]</sup>
HMC409LP4	Low Stress Injection Molded Plastic	Sn/Pb Solder	MSL1 <sup>[1]</sup>	H409 XXXX
HMC409LP4E	RoHS-compliant Low Stress Injection Molded Plastic	100% matte Sn	MSL1 <sup>[2]</sup>	H409 XXXX

[1] Max peak reflow temperature of 235 °C

[2] Max peak reflow temperature of 260 °C

[3] 4-Digit lot number XXXX

### Application Circuit

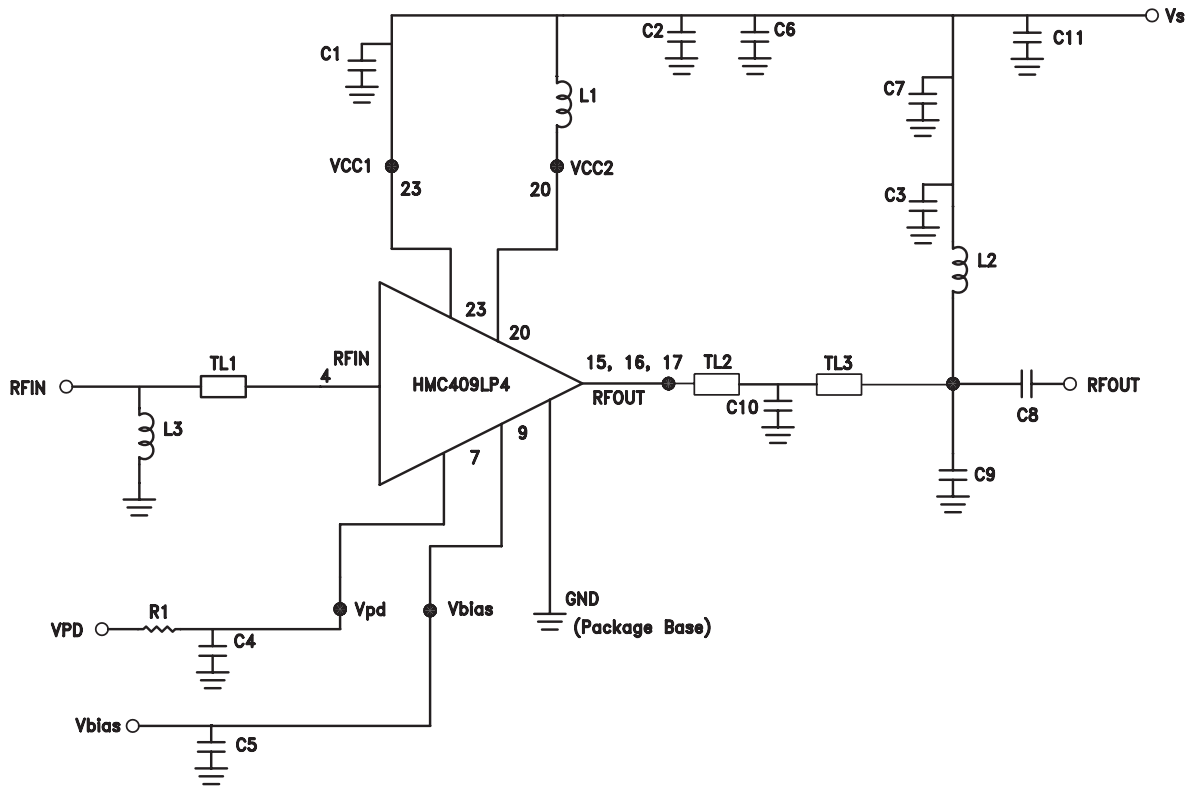



Recommended Component Values	
C1 - C5	100pF
C6 - C7	1000pF
C8	10 pF
C9	0.5 pF
C10	1.6 pF
C11	4.7μF
L1, L2	3.9 nH
L3	2.2 nH
R1	56 Ohm

	TL1	TL2	TL3
Impedance	50 Ohm	50 Ohm	50 Ohm
Physical Length	0.048"	0.12"	0.052"
Electrical Length	10°	24°	11°
PCB Material: 10 mil Rogers 4350, Er = 3.48			

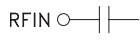
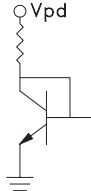
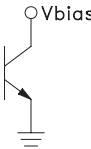
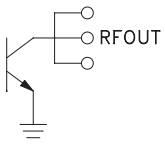
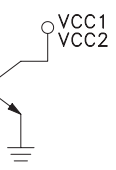

**Pin Descriptions**

Pin Number	Function	Description	Interface Schematic
1-3, 5, 6, 8, 10 -14, 18, 19, 21, 22, 24	N/C	No connection required. These pins may be connected to RF/DC ground without affecting performance.	
4	RFIN	This pin is AC coupled and matched to 50 Ohms from 3.3 - 3.8 GHz.	
7	Vpd	Power control pin. For maximum power, this pin should be connected to 5.0V thru a 56 Ω resistor. A high-voltage or small resistor is not recommended for lower idle current. This voltage can be reduced or the resistor increased.	
9	Vbias	DC power supply pin for bias circuitry	
15, 16, 17	RFOUT	RF output and DC bias for the output stage.	
20	VCC2	Power supply voltage for the second amplifier stage. External bypass capacitors and pull up choke are required as shown in the application schematic.	
23	VCC1	Power supply voltage for the first amplifier stage. External bypass capacitors are required as shown in the application schematic.	
	GND	Ground: Backside of package has exposed metal ground slug that must be connected to ground thru a short path. Vias under the device are required.	

**Evaluation PCB**

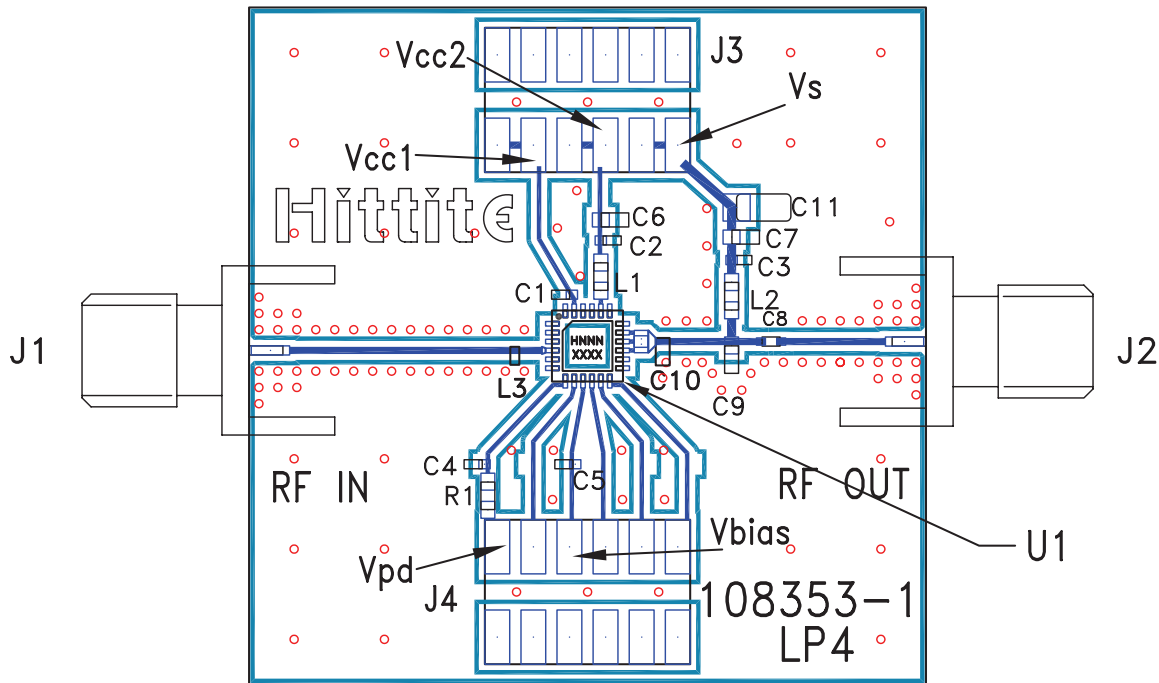

**List of Materials for Evaluation PCB 108355 [1]**

Item	Description
J1 - J2	PCB Mount SMA RF Connector
J3, J4	2 mm DC Header
C1 - C5	100 pF Capacitor, 0402 Pkg.
C6 - C7	1000 pF Capacitor, 0603 Pkg.
C8	10 pF Capacitor, 0402 Pkg.
C9	0.5 pF Capacitor, 0603 Pkg.
C10	1.6 pF Capacitor, 0603 Pkg.
C11	4.7 $\mu$ F, Tantalum
L1, L2	3.9 nH Inductor, 0603 Pkg.
L3	2.2 nH Inductor, 0402 Pkg. Toko
R1	56 Ohm Resistor, 0603 Pkg.
U1	HMC409LP4 / HMC409LP4E Amplifier
PCB [2]	108353 Eval Board

[1] Reference this number when ordering complete evaluation PCB

[2] Circuit Board Material: Rogers 4350, Er = 3.48

The circuit board used in the final application should use RF circuit design techniques. Signal lines should have 50 ohm impedance while the package ground leads and exposed paddle should be connected directly to the ground plane similar to that shown. A sufficient number of VIA holes should be used to connect the top and bottom ground planes. The evaluation board should be mounted to an appropriate heat sink. The evaluation circuit board shown is available from Hittite upon request.