

Typical Applications

LNA & Transmit/Receive Switch
Front-End for 2.4 GHz Applications:

- 802.11 WLAN
- BLUETOOTH
- HomeRF
- ISM Radios

Functional Diagram

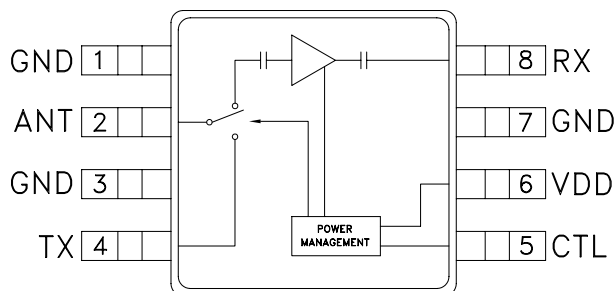

Features

- Gain: 8 dB
- Noise Figure: 2.5 dB
- Integrated LNA & Switch
- Integrated Power Control:
+3V Operation
- Ultra Small Package: MSOP8

General Description

The HMC309MS8 is a versatile integrated low noise amplifier (LNA) and transmit/receive switch front-end for 2.3 to 2.5 GHz spread spectrum applications. The LNA offers 8 dB gain and 2.5 dB noise figure while the transmit switch path has 0.5 dB insertion loss and better than +30 dBm linear power handling. Using a single control line, the LNA is powered down when the switch Tx port is selected minimizing I_{dd} current consumption to 5 mA in the Rx mode and 200 uA in the Tx mode at V_{dd} = +3V bias. The HMC309MS8 may be directly interfaced with popular 2.4 GHz transceiver chips. At a height of 0.040" (1.0mm), the MSOP8 package is ideal for low profile portable wireless devices.

Electrical Specifications, $T_A = +25^\circ C$, $V_{dd} = +3V$

Parameter	LNA (Rx) Path			Switched Path			Units
	Min.	Typ.	Max.	Min.	Typ.	Max.	
Frequency Range	2.3 - 2.5			2.3 - 2.5			GHz
Gain	5	8	10	-0.6	-0.4		dB
Gain Variation over Temperature		0.012	0.02				dB/°C
Noise Figure		2.5	3.8		0.45		dB
Input Return Loss		5		14	25		dB
Output Return Loss		13		16	20		dB
Output Power for 1 dB Compression (P1dB)*	2	6		30	33		dBm
Output or Input Third Order Intercept (IP3)*	5	8		27	40		dBm
Supply Current (I _{dd})		5	10		0.2	0.4	mA

* The LNA P1dB & IP3 are referenced to the Rx pin output while the switch P1dB & IP3 are referenced to the Tx pin

LNA Broadband Gain & Return Loss

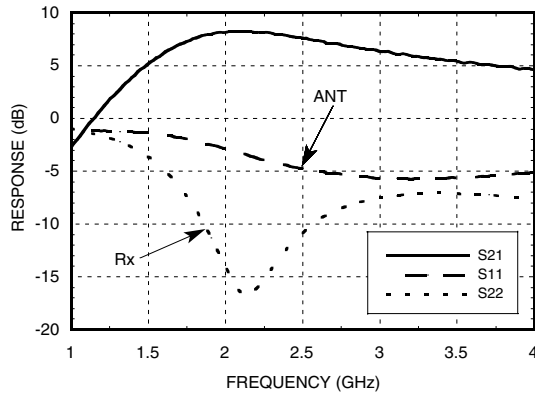

LNA Gain vs. Temperature, ANT to Rx

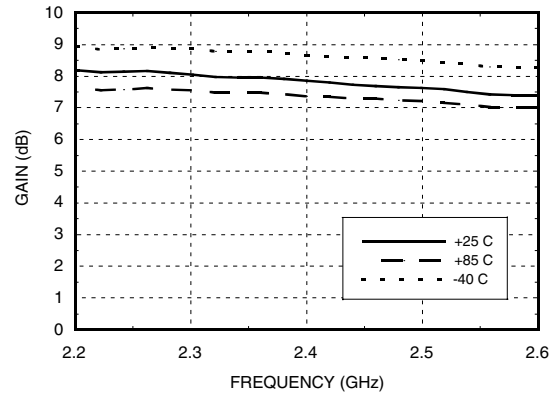

LNA Input Return Loss @ ANT vs. Temperature

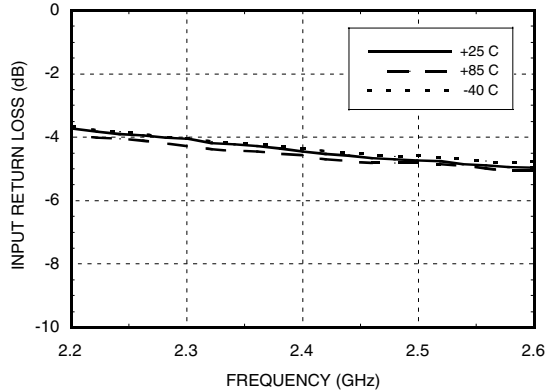

LNA Output Return Loss @ Rx vs. Temperature

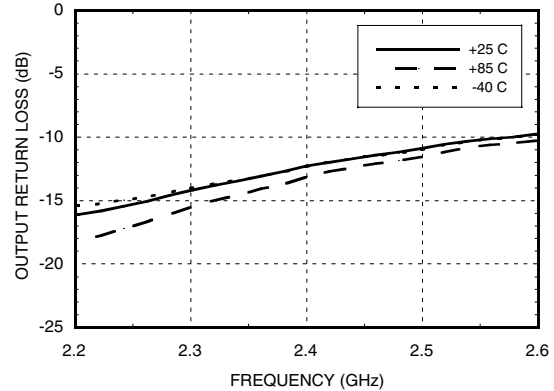

LNA Noise Figure vs. Temperature, ANT to Rx

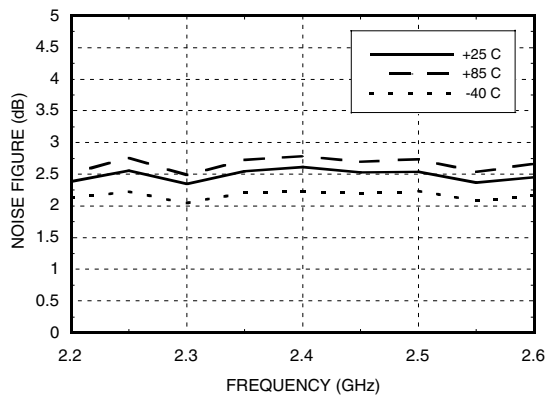

LNA Power Compression @ 2.4 GHz

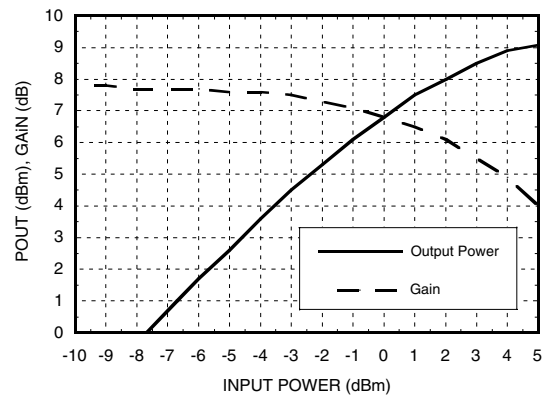

**GaAs MMIC 2.4 GHz FRONT-END
LNA / SWITCH**

**Switch Path Broadband
Insertion Loss & Return Loss**

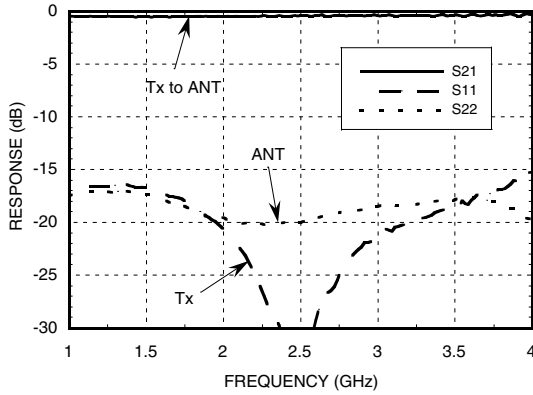

**Switch Path Insertion
Loss vs. Temperature, Tx to ANT**

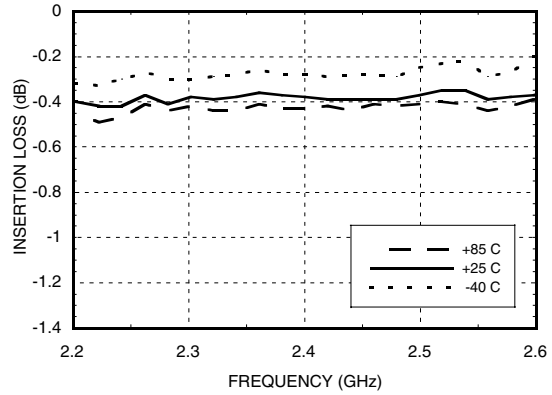

**Switch Path Input
Return Loss @ Tx vs. Temperature**

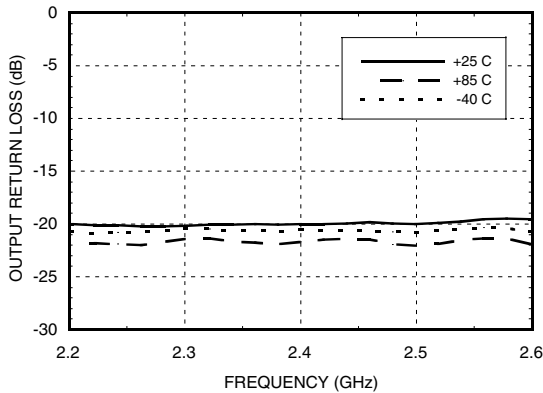

**Switch Path Output
Return Loss @ ANT vs. Temperature**

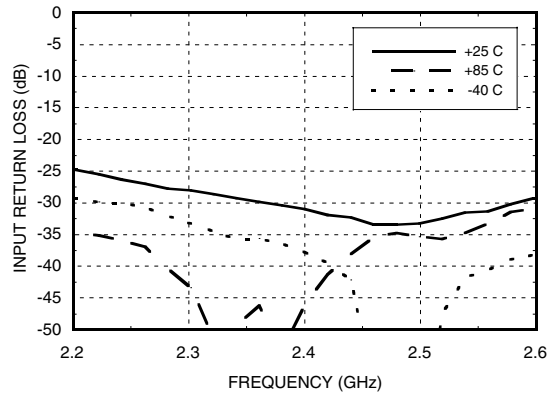

IP3 vs. Temperature

Temperature	Frequency = 2.4 GHz	
	LNA (Rx) Path	Switched Path
-40 °C	8.3	41.4
+25 °C	8.2	39.6
+85 °C	7.8	44.2

All levels in dBm
LNA path Output IP3 referenced to Rx port
Switched path Input IP3 referenced to Tx port

Tx/Rx Isolation

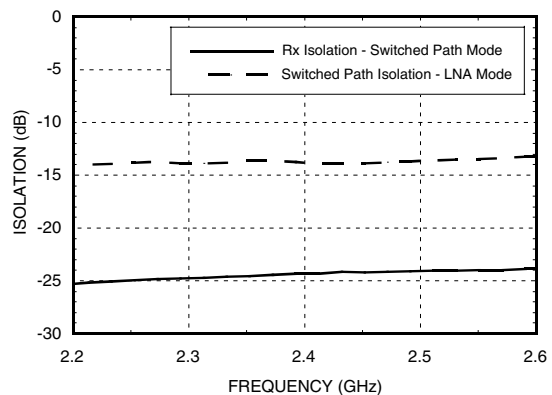

Absolute Maximum Ratings

Drain Bias Voltage (Vdd)	+8.0 Vdc
Control Voltage Range (CTL)	-0.2V to Vdd
Input Power @ ANT (LNA "ON", Vdd = +3.0 Vdc)	+10 dBm
Input Power @ Tx (Switch "ON", Vdd = +3.0 Vdc)	+34 dBm
Channel Temperature	150 °C
Continuous P _{diss} (T = 85 °C) (derate 0.6 mW/°C above 85 °C)	0.039 W
Thermal Resistance (channel to lead)	1666 °C/W
Storage Temperature	-65 to +150 °C
Operating Temperature	-40 to +85 °C

Outline Drawing

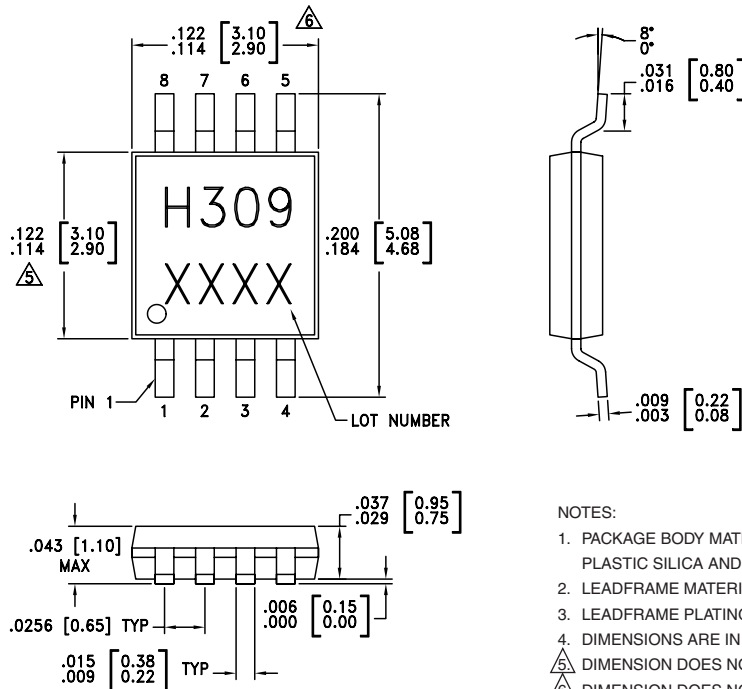

NOTES:

1. PACKAGE BODY MATERIAL: LOW STRESS INJECTION MOLDED PLASTIC SILICA AND SILICON IMPREGNATED.
2. LEADFRAME MATERIAL: COPPER ALLOY
3. LEADFRAME PLATING: Sn/Pb SOLDER
4. DIMENSIONS ARE IN INCHES [MILLIMETERS].
- △ DIMENSION DOES NOT INCLUDE MOLDFLASH OF 0.15mm PER SIDE.
- △ DIMENSION DOES NOT INCLUDE MOLDFLASH OF 0.25mm PER SIDE.
7. ALL GROUND LEADS MUST BE SOLDERED TO PCB RF GROUND.

Application Circuit

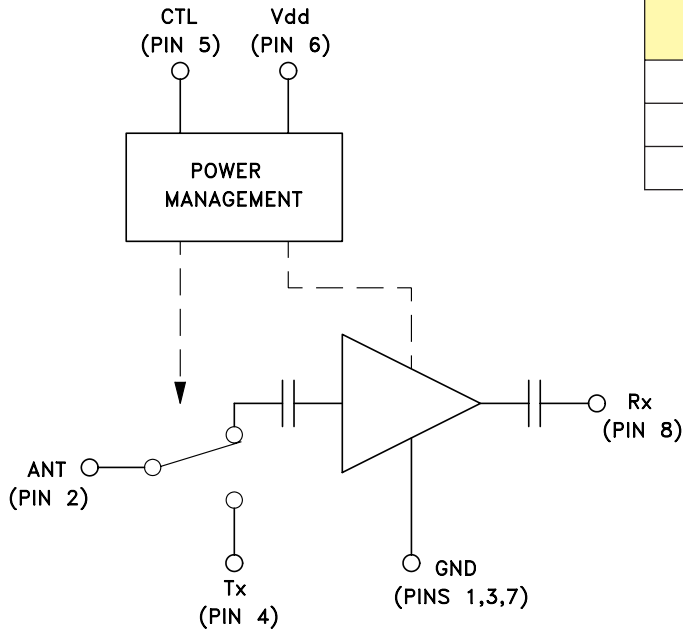

Truth Table

Control Input Tolerances are ± 0.2 Vdc.

Control Input (Vdc)	Signal Path	
	ANT to Rx	Tx to ANT
0	On	Off
+3	Off	On

Note: DC blocking capacitors are required on the ANT port (Pin 2) and the Tx port (Pin 4).

Evaluation PCB

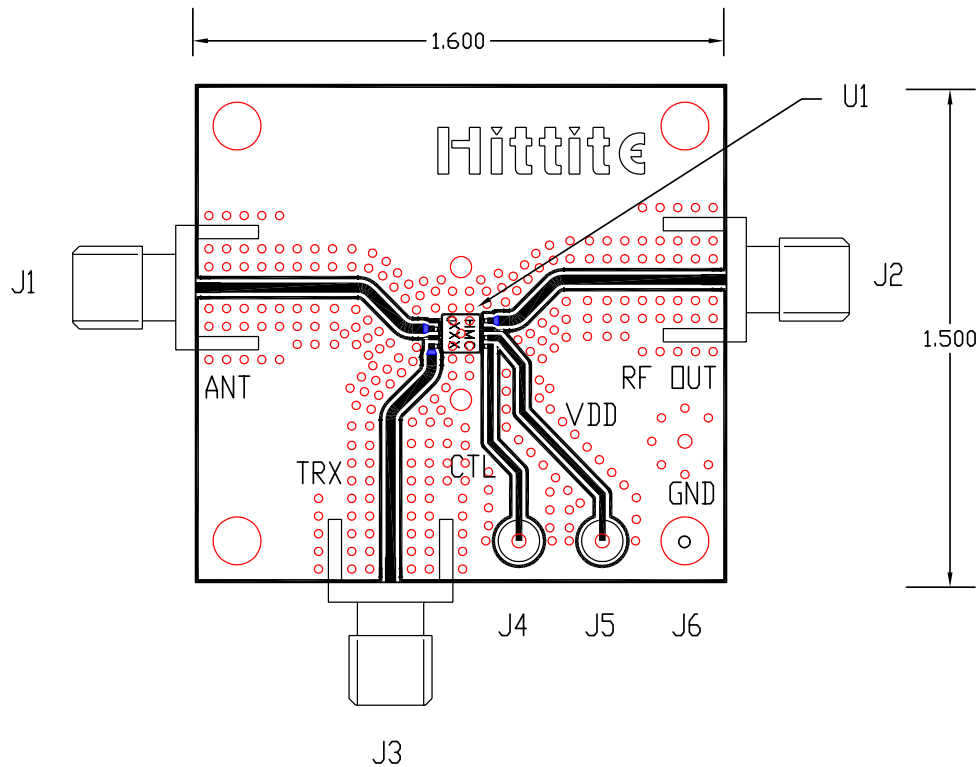

List of Material

Item	Description
J1, J2, J3	PC Mount SMA Connector
J4, J5, J6	DC Pins
U1	HMC309MS8 Amplifier
PCB*	Evaluation Board 1.5" x 1.55"
*Circuit Board Material: Roger 4350	

The circuit board used in the final application should use RF circuit design techniques. Signal lines should have 50 ohm impedance while the package ground leads should be connected directly to the ground plane similar to that shown. A sufficient number of VIA holes should be used to connect the top and bottom ground planes. The evaluation circuit board shown is available from Hittite upon request.