

### Typical Applications

The HMC260LC3B is ideal for:

- Point-to-Point Radios
- Point-to-Mult-Point Radios & VSAT
- Test Equipment & Sensors
- Military End-Use

### Features

- Passive: No DC Bias Required
- Input IP3: +20 dBm
- LO/RF Isolation: 40 dB
- Wide IF Bandwidth: DC - 8 GHz
- 12 Lead Ceramic 3x3 mm SMT Package: 9mm<sup>2</sup>

### Functional Diagram

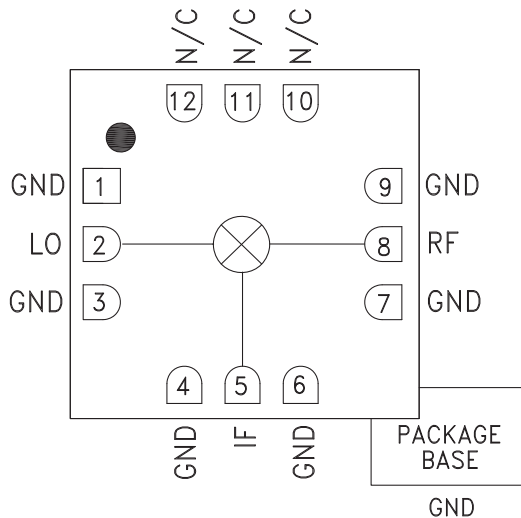

### General Description

The HMC260LC3B is a general purpose double balanced mixer in a leadless RoHS compliant SMT package that can be used as an upconverter or downconverter between 14 and 26 GHz. This mixer requires no external components or matching circuitry. The HMC260LC3B provides excellent LO to RF and LO to IF suppression due to optimized balun structures. The mixer operates with LO drive levels above +9 dBm. The HMC260LC3B eliminates the need for wire bonding, allowing use of surface mount manufacturing techniques.

### Electrical Specifications, $T_A = +25^\circ \text{C}$ , $IF = 1 \text{ GHz}$ , $LO = +13 \text{ dBm}^*$

Parameter	Min.	Typ.	Max.	Min.	Typ.	Max.	Units
Frequency Range, RF & LO		14 - 18		18 - 26			GHz
Frequency Range, IF		DC - 8		DC - 8			GHz
Conversion Loss		7.5	10.5		9	12	dB
Noise Figure (SSB)		7.5	10.5		9	12	dB
LO to RF Isolation	34	40		30	35		dB
LO to IF Isolation	24	30		24	35		dB
RF to IF Isolation	15	25		25	30		dB
IP3 (Input)		18			20		dBm
IP2 (Input)		50			50		dBm
1 dB Gain Compression (Input)		12			14		dBm

\*Unless otherwise noted, all measurements performed as downconverter,  $IF = 1 \text{ GHz}$ .

**Conversion Gain vs. Temperature**

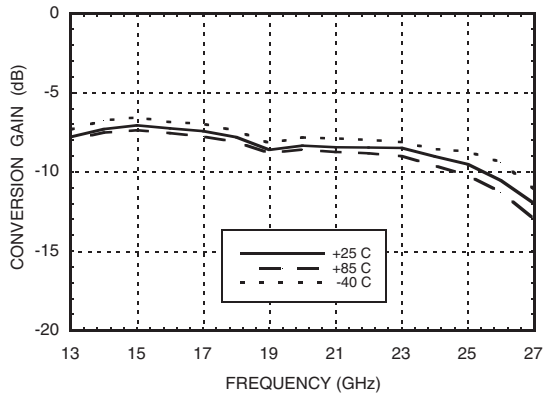

**Isolation**

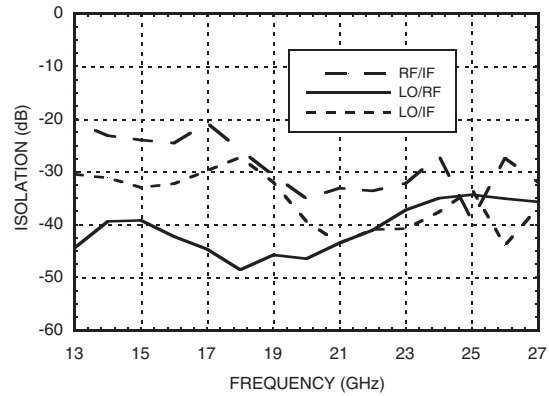

**Conversion Gain vs. LO Drive**

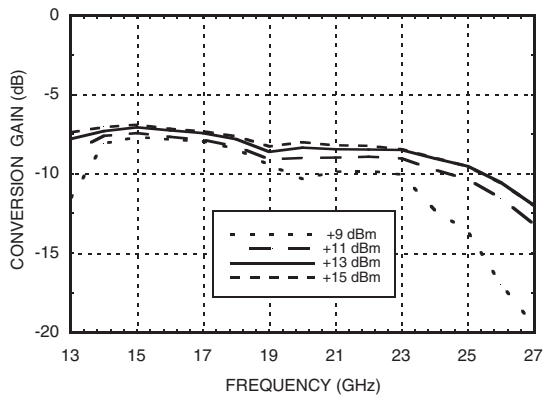

**Return Loss**

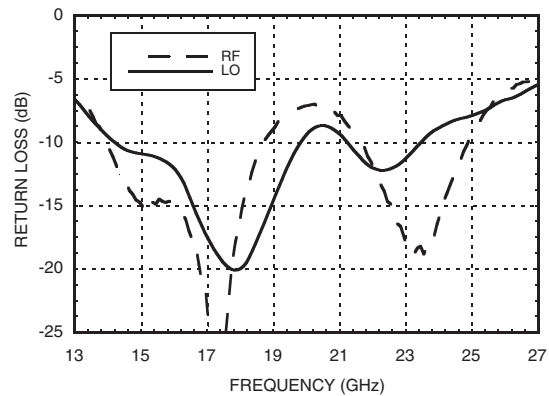

**IF Bandwidth**

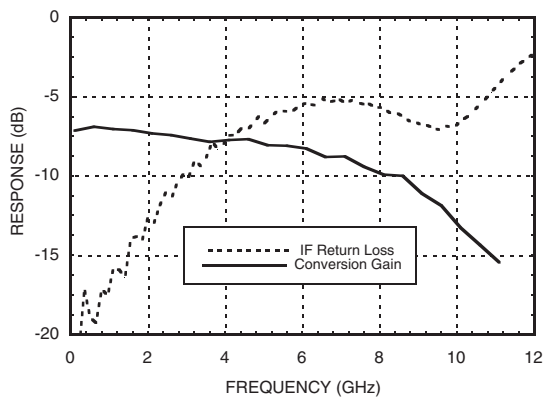

**Upconverter Performance  
Conversion Gain vs. LO Drive**

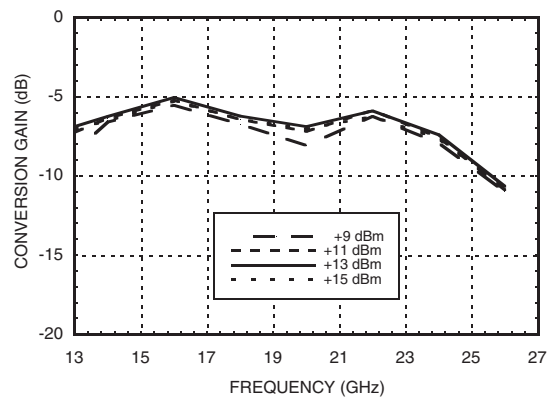

**Input IP3 vs. LO Drive \***

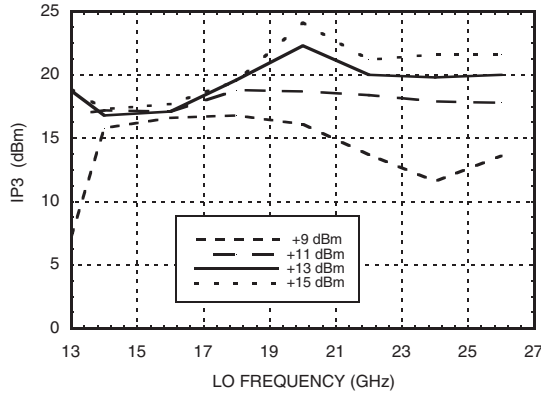

**Input IP3 vs. Temperature \***

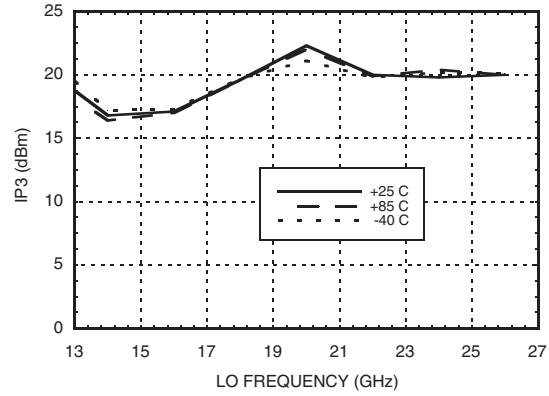

**Input IP2 vs. LO Drive \***

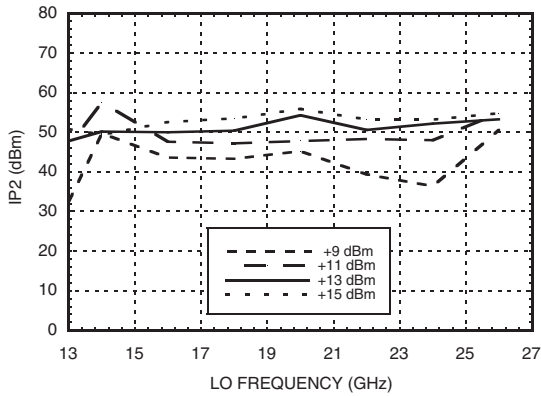

**Input IP2 vs. Temperature \***

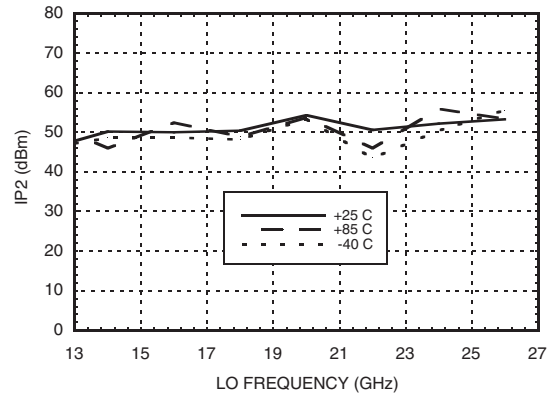

**Input P1dB vs. Temperature**

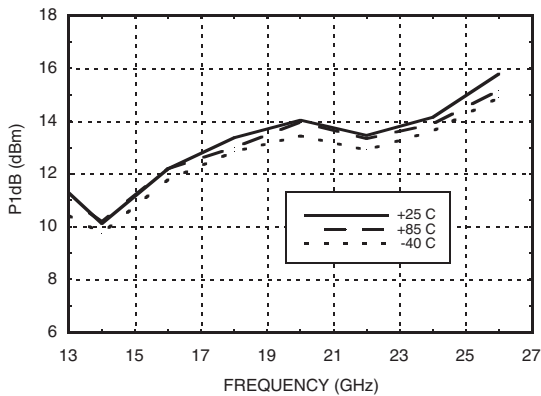

**MxN Spurious Outputs**

	nLO				
mRF	0	1	2	3	4
0	xx	-2	17	xx	xx
1	18	0	38	50	78
2	82	74	71	65	84
3	xx	90	95	77	90
4	xx	xx	93	98	104

RF = 18 GHz @ -10 dBm  
 LO = 17 GHz @ +13 dBm  
 All values in dBc below the IF output power level.

\* Two-tone input power = -10 dBm each tone, 1 MHz spacing.

**Absolute Maximum Ratings**

RF / IF Input	+15 dBm
LO Drive	+27 dBm
Channel Temperature	150 °C
Continuous Pdiss (Ta = 85 °C) (derate 3.95 mW/°C above 85 °C)	260 mW
Thermal Resistance (junction to ground paddle)	253 °C/W
Storage Temperature	-65 to +150 °C
Operating Temperature	-40 to +85 °C
ESD Sensitivity (HBM)	Class 1A

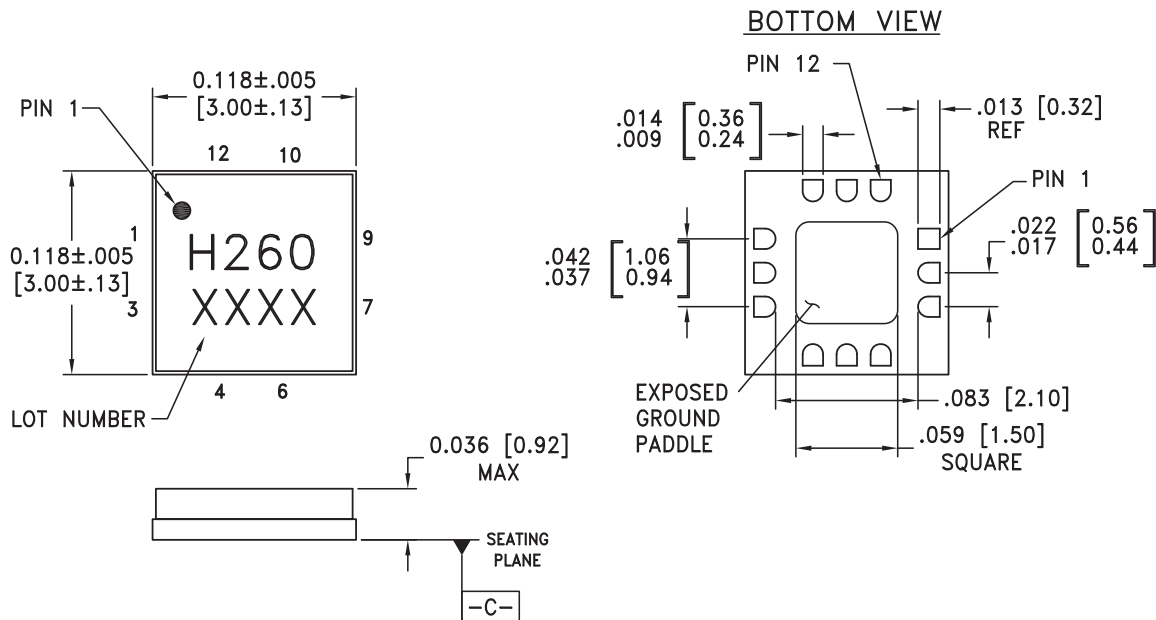

ELECTROSTATIC SENSITIVE DEVICE  
OBSERVE HANDLING PRECAUTIONS

**Outline Drawing**

## NOTES:

1. PACKAGE BODY MATERIAL: ALUMINA.
2. LEAD AND GROUND PADDLE PLATING: GOLD FLASH OVER NICKEL.
3. DIMENSIONS ARE IN INCHES (MILLIMETERS).
4. LEAD SPACING TOLERANCE IS NON-CUMULATIVE.
5. CHARACTERS TO BE HELVETICA MEDIUM, .025 HIGH, BLACK INK, OR LASER MARK LOCATED APPROX. AS SHOWN.
6. PACKAGE WARP SHALL NOT EXCEED 0.05MM DATUM - C -
7. ALL GROUND LEADS AND GROUND PADDLE MUST BE SOLDERED TO PCB RF GROUND.
8. CLASSIFIED AS MOISTURE SENSITIVITY LEVEL (MSL) 1.

**Pin Descriptions**

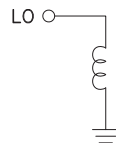
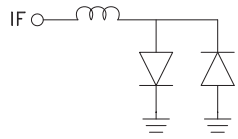
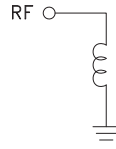
Pin Number	Function	Description	Interface Schematic
1, 3, 4, 6, 7, 9	GND	Package bottom must also be connected to RF/DC ground.	
2	LO	This pin is DC coupled and matched to 50 Ohm.	
5	IF	This pin is DC coupled. For applications not requiring operation to DC, this port should be DC blocked externally using a series capacitor whose value has been chosen to pass the necessary IF frequency range. For operation to DC, this pin must not source or sink more than 2 mA of current or part non-function and possible part failure will result.	
8	RF	This pin is DC coupled and matched to 50 Ohm.	
10, 11, 12	N/C	No connection required. These pins may be connected to RF/DC ground without affecting performance.	

**Evaluation PCB**

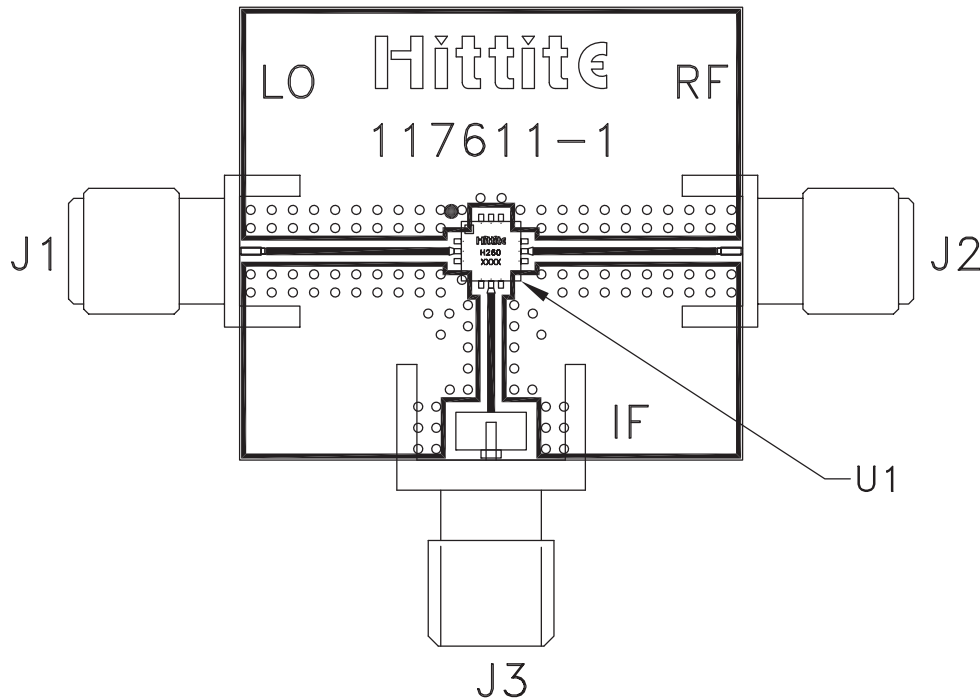

**List of Materials for Evaluation PCB 109952 [1]**

Item	Description
J1 - J2	SRI SMA Connector
J3	Johnson SMA Connector
U1	HMC260LC3B Mixer
PCB [2]	117611 Evaluation PCB

[1] Reference this number when ordering complete evaluation PCB

[2] Circuit Board Material: Arlon 25 RF

The circuit board used in this application should use RF circuit design techniques. Signal lines should have 50 ohm impedance while the package ground leads and exposed paddle should be connected directly to the ground plane similar to that shown. A sufficient number of via holes should be used to connect the top and bottom ground planes. The evaluation board should be mounted to an appropriate heat sink. The evaluation circuit board shown is available from Hittite upon request.