

## GaAs MMIC PASSIVE FREQUENCY DOUBLER, 4 - 8 GHz INPUT

### Typical Applications

The HMC204 is suitable for:

- Wireless Local Loop
- LMDS, VSAT, and Pt to Pt Radios
- Test Equipment

### Features

- Conversion Loss: 17 dB
- Fo, 3Fo, 4Fo Isolation: 38 dB
- Passive: No Bias Required

### Functional Diagram

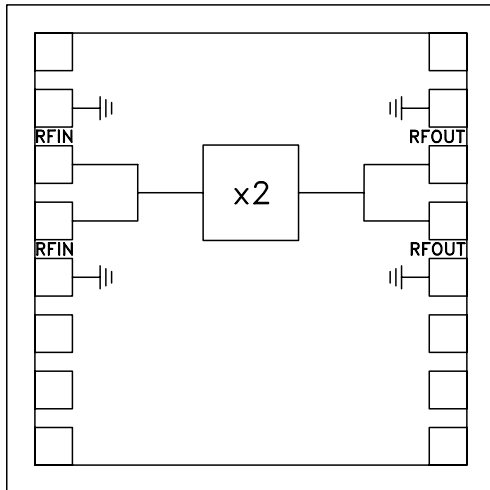

### General Description

The HMC204 is a passive miniature frequency doubler in a MMIC die. Suppression of undesired fundamental and higher order harmonics is 38 dB typical with respect to input signal level. The doubler utilizes the same GaAs Schottky diode/balun technology found in Hittite MMIC mixers. It features small size, no DC bias, and no measurable additive phase noise onto the multiplied signal.

### Electrical Specifications, $T_A = +25^\circ\text{C}$ , As a Function of Drive Level

Parameter	Input = +10 dBm			Input = +12 dBm			Input = +15 dBm			Units
	Min.	Typ.	Max.	Min.	Typ.	Max.	Min.	Typ.	Max.	
Frequency Range, Input	5.5 - 7.5			5.0 - 8.0			4.0 - 8.0			GHz
Frequency Range, Output	11.0 - 15.0			10.0 - 16.0			8.0 - 16.0			GHz
Conversion Loss		17	20		17	20		18	21	dB
FO Isolation (with respect to input level)				41	45					dB
3FO Isolation (with respect to input level)				42	46					dB
4FO Isolation (with respect to input level)				35	38					dB

## GaAs MMIC FREQUENCY DOUBLER, 4 - 8 GHz INPUT

**Conversion Gain vs Temperature @ +15 dBm Drive Level**

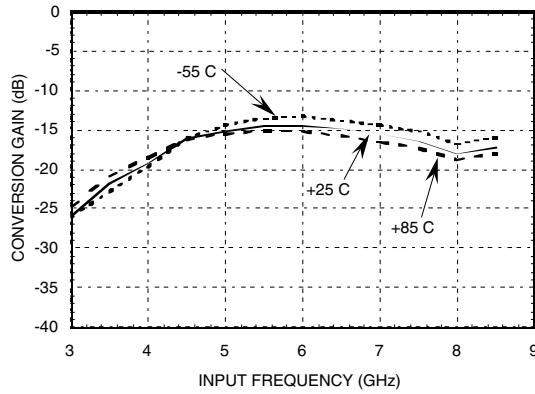

**Isolation @ +15 dBm Drive Level\***

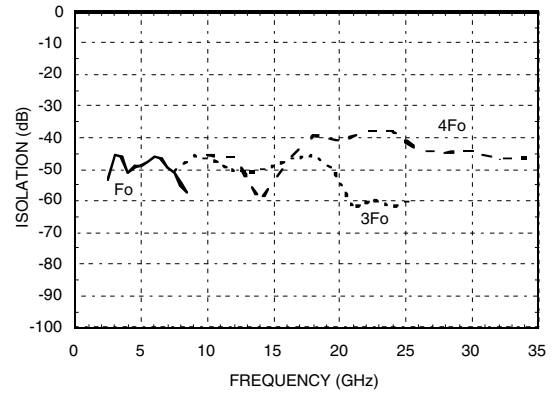

\*With respect to input level

**Input Return Loss vs. Drive Level**

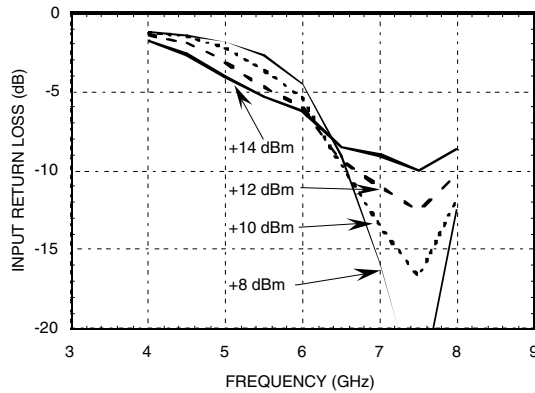

**Output Return Loss for Several Input Frequencies**

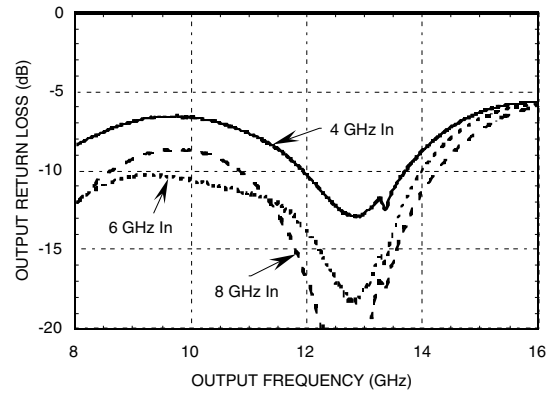

## GaAs MMIC FREQUENCY DOUBLER, 4 - 8 GHz INPUT

4

FREQ. MULTIPLIERS - CHIP

**Conversion Gain @ 25°C vs. Drive Level**

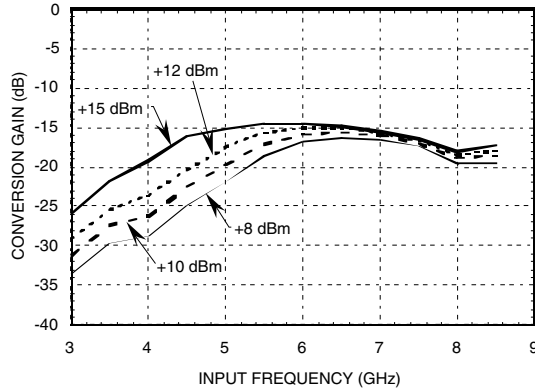

**Output Return Loss with 4 GHz Input**

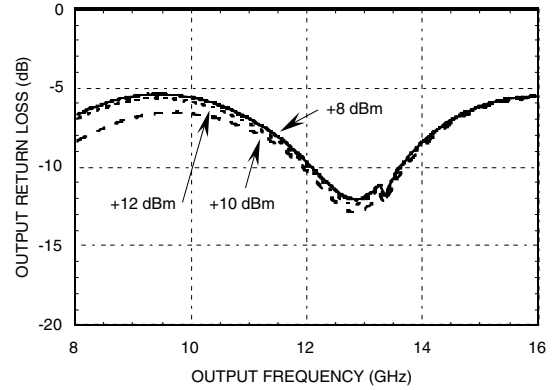

**Conversion Gain @ -55°C vs. Drive Level**

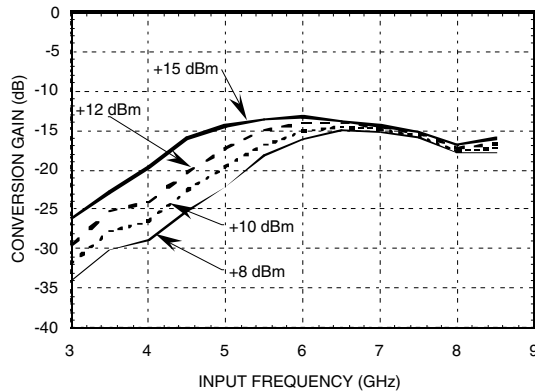

**Output Return Loss with 6 GHz Input**

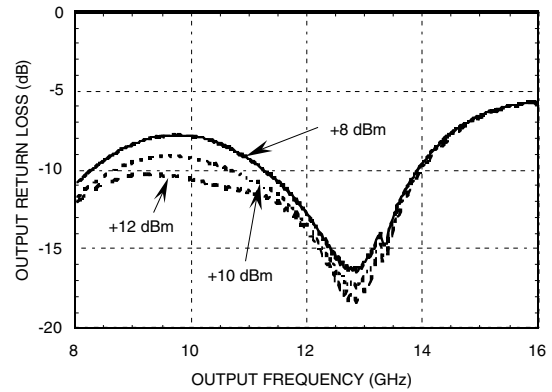

**Conversion Gain @ +85°C vs. Drive Level**

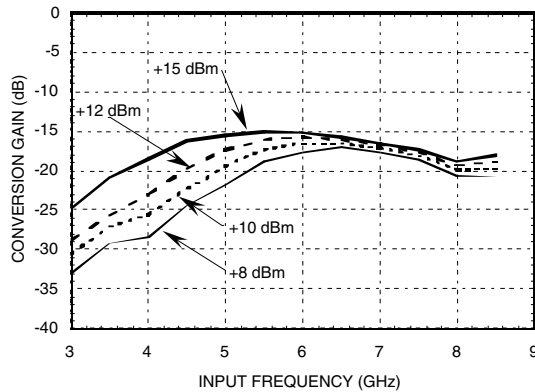

**Output Return Loss with 8 GHz Input**

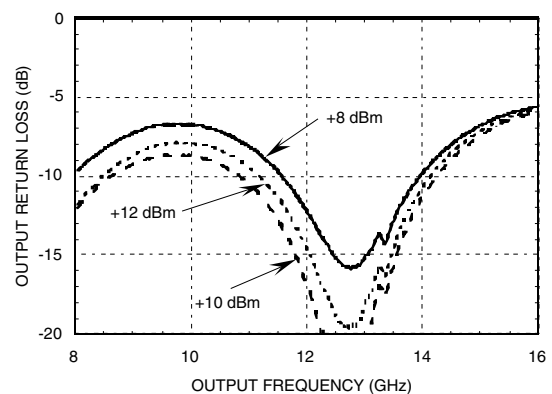

## GaAs MMIC FREQUENCY DOUBLER, 4 - 8 GHz INPUT

### Absolute Maximum Ratings

Input Drive	+27 dBm
Storage Temperature	-65 to +150 °C
Operating Temperature	-55 to +85 °C

### Outline Drawing

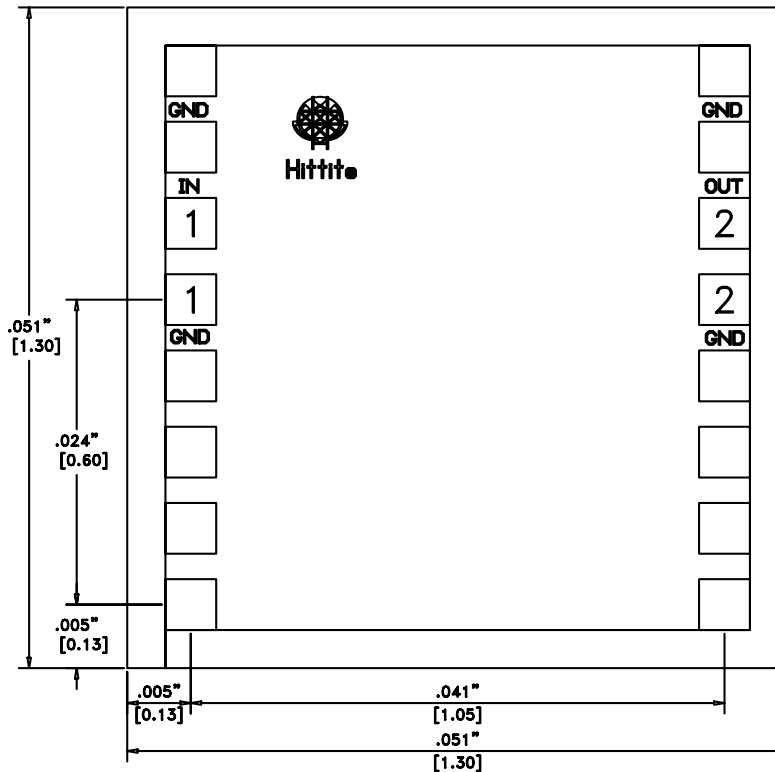

NOTES:

1. DIE THICKNESS IS 0.100 [0.004], BACKSIDE IS GROUND
2. BOND PADS ARE 0.100 [0.004] SQUARE
3. BOND PAD SPACING, CTR-CTR: 0.150 [0.006]
4. ALL DIMENSION IN INCHES [MILLIMETERS]
5. ALL TOLERANCES ARE  $\pm 0.025$  [ $\pm 0.001$ ]
6. BOND PAD METALLIZATION: GOLD
7. BACKSIDE METALLIZATION: GOLD

**GaAs MMIC FREQUENCY  
DOUBLER, 4 - 8 GHz INPUT****Handling Precautions**

Follow these precautions to avoid permanent damage.

**Cleanliness:** Handle the chips in a clean environment. DO NOT attempt to clean the chip using liquid cleaning systems.

**Static Sensitivity:** Follow ESD precautions to protect against  $> \pm 250V$  ESD strikes.

**Transients:** Suppress instrument and bias supply transients while bias is applied. Use shielded signal and bias cables to minimize inductive pick-up.

**General Handling:** Handle the chip along the edges with a vacuum collet or with a sharp pair of bent tweezers. The surface of the chip has fragile air bridges and should not be touched with vacuum collet, tweezers, or fingers.

**Mounting**

The chip is back-metallized and can be die mounted with AuSn eutectic preforms or with electrically conductive epoxy. The mounting surface should be clean and flat.

**Epoxy Die Attach:**

Apply a minimum amount of epoxy to the mounting surface so that a thin epoxy fillet is observed around the perimeter of the chip once it is placed into position.

Cure epoxy per the manufacturer's schedule.

**Wire Bonding**

Ball or wedge bond with 1.0 diameter pure gold wire. Thermosonic wirebonding with a nominal stage temperature of 150 °C and a ball bonding force of 40 to 50 grams or wedge bonding force of 18 to 22 grams is recommended. Use the minimum level of ultrasonic energy to achieve reliable wirebonds. Wirebonds should be started on the chip and terminated on the package. RF bonds should be as short as possible.

## *GaAs MMIC FREQUENCY DOUBLER, 4 - 8 GHz INPUT*

**Notes:**